

MANUAL CHANGES

HP 4195A

Network/Spectrum Analyzer

MANUAL IDENTIFICATION

Model Number: HP 4195A
Date Printed: July 1989
Part Number: 04195-90000

This supplement contains information for correcting manual errors and for adapting the manual to newer instruments that contain improvements or modifications not documented in the existing manual.

To use this supplement

1. Make all ERRATA corrections
2. Make all appropriate serial-number-related changes listed below

SERIAL PREFIX OR NUMBER MAKE MANUAL CHANGES

SERIAL PREFIX OR NUMBER	MAKE MANUAL CHANGES

SERIAL PREFIX OR NUMBER MAKE MANUAL CHANGES

SERIAL PREFIX OR NUMBER	MAKE MANUAL CHANGES

► New Item

► ERRATA

Inside Front Cover, SERIAL NUMBERS

Change first paragraph as follows.

This manual applies directly to instruments whose serial number prefix is 2904J- or 2904A-, and whose ROM-based firmware is version 2.00.

NOTE

Manual change supplements are revised as often as necessary to keep manuals as current and accurate as possible. Hewlett-Packard recommends that you periodically request the latest edition of this supplement. Free copies are available from all HP offices. When requesting copies, quote the manual identification information from your supplement, or the model number and print date from the title page of the manual.

Date/Div: November 1989/33

Page: 1 of 2



Page A-2, APPENDIX A Manual Backdating; CHANGE 2

Delete the following item.

Page 4-58, 4-16-1. EXTERNAL REFERENCE SIGNAL INPUT

Frequency: 10/N MHz, ± 10 ppm ...
--> 10/N MHz, ± 30 ppm ...

Page 7-7, Table 7-1 (1 of 15), EXTERNAL STANDARD FREQUENCY INPUT

Frequency: 10/N MHz, ≤ 10 ppm ...
--> 10/N MHz, ≤ 30 ppm ...

Page 7-8, Table 7-1 (2 of 15), Output: Sweep:

Power Sweep Linearity: "at -50 dBm to +10 dBm" --> DELETE

Page 7-11, Table 7-1 (5 of 15), Phase:

Frequency Response: "Deviation from linear phase." --> DELETE

Page 7-13, Table 7-1 (7 of 15), Frequency:

Resolution: Selectivity (60 dB/3 dB): < 9 at $100 \text{ Hz} \leq \text{RBW} \leq 10 \text{ kHz}$
--> < 12

Page 7-17, Table 7-1 (11 of 15)

Dynamic Range Chart --> DELETE

MANUAL CHANGES

HP 4195A

Network/Spectrum Analyzer

MANUAL IDENTIFICATION

Model Number: HP 4195A
Date Printed: July 1989
Part Number: 04195-90000

This supplement contains information for correcting manual errors and for adapting the manual to newer instruments that contain improvements or modifications not documented in the existing manual.

To use this supplement

1. Make all ERRATA corrections
2. Make all appropriate serial-number-related changes listed below

SERIAL PREFIX OR NUMBER	MAKE MANUAL CHANGES

SERIAL PREFIX OR NUMBER	MAKE MANUAL CHANGES

► New Item

ERRATA

Page 4-23, 4-8-5. PORT EXTENSION

Add the following description and figure.

Each port of R1, T1, R2, T2, and port 1, port 2 (when the transmission/reflection test set(s) is used) can be extended by entering electrical length value for each one. Refer to Figure 4-5-1.

NOTE

The ports required no extension must be entered value "0".

NOTE

Manual change supplements are revised as often as necessary to keep manuals as current and accurate as possible. Hewlett-Packard recommends that you periodically request the latest edition of this supplement. Free copies are available from all HP offices. When requesting copies, quote the manual identification information from your supplement, or the model number and print date from the title page of the manual.

Date/Div: June 1990/33
Page: 1 of 2



EXAMPLE 1

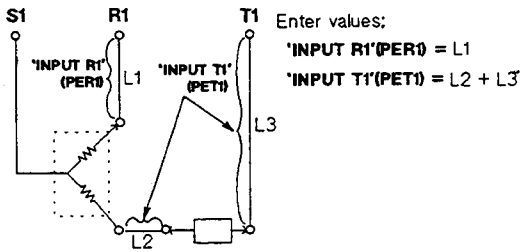

EXAMPLE 2

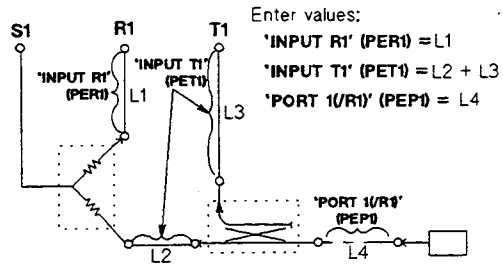

EXAMPLE 3

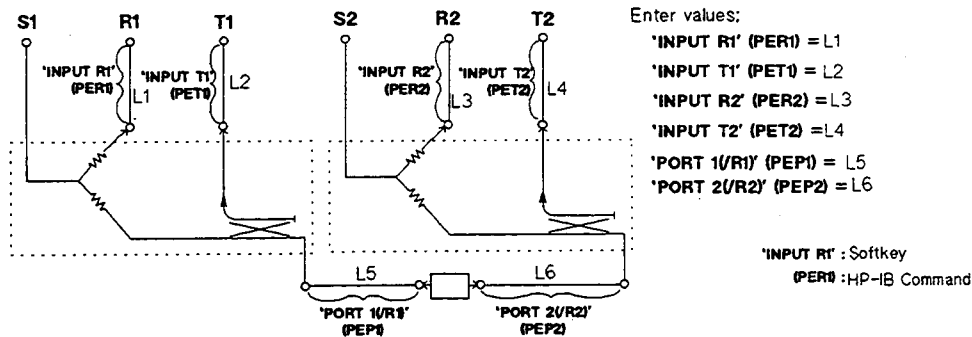

Figure 4-5-1. Port Extension

Page 7-5, 7-8-1. ENVIRONMENT

Change as follows.

Temperature: -40°C to +60°C
 Humidity: 8 to 95% RH, Wet Bulb Temperature ≤ 29°C

Page 7-7, GENERAL SPECIFICATION

Change as follows.

Operating Environment:

Temperature:	when disc drive is not used:	0°C to +55°C
	when disc drive is used:	5°C to +50°C
Humidity:	when disc drive is not used:	15 to 95% RH, Wet Bulb Temperature ≤ 29°C
	when disc drive is used:	8 to 80% RH, Wet Bulb Temperature ≤ 29°C

Storage Environment: Temperature: -40°C to +60°C
 Humidity: 8 to 95% RH, Wet Bulb Temperature ≤ 29°C

Page 7-8, Table 7-1 Specifications (2 of 14)

Change Level Accuracy, Flatness to ± 2.9 dB

Page A-1/2, Appendix A, MANUAL CHANGE, Table A

Change Serial Prefix or Number to 2830J and below.

HP 4195A Network/Spectrum Analyzer

Operation Manual

MANUAL IDENTIFICATION

Model Number: HP 4195A
Date Printed: Jul. 1989
Part Number: 04195-90000

This supplement contains information for correcting manual errors and for adapting the manual to newer instruments that contains improvements or modifications not documented in the existing manual.

To use this supplement

1. Make all ERRATA corrections
2. Make all appropriate serial-number-related changes listed below

SERIAL PREFIX OR NUMBER MAKE MANUAL CHANGES

SERIAL PREFIX OR NUMBER	MAKE MANUAL CHANGES

SERIAL PREFIX OR NUMBER MAKE MANUAL CHANGES

SERIAL PREFIX OR NUMBER	MAKE MANUAL CHANGES

► New Item

CHANGE

Page 7-8, Table 7-1, Specifications (2 of 15)

Change as follows:

Output

- Level Accuracy:

Accuracy:

± 1.2 dB at +10 dbm, 50 MHz (23 ± 5 °C)

NOTE

Manual change supplement are revised as often as necessary to keep manuals as current and accurate as possible. Hewlett-Packard recommends that you periodically request the latest edition of this supplement. Free copies are available from all HP offices. When requesting copies, quote the manual identification information from your supplement, or the model number and print date from the title page of the manual.

GERÄUSCHEMISSION

Lpa < 70 dB
am Arbeitsplatz
normaler Betrieb
nach DIN 45635 T. 19

ACOUSTIC NOISE EMISSION

Lpa < 70 dB
operator position
normal operation
per ISO 7779



HEWLETT
PACKARD

OPERATION MANUAL

MODEL 4195A

NETWORK/SPECTRUM

ANALYZER

(Including Option 001)

SERIAL NUMBERS

This manual applies directly to instruments whose serial number prefix is 2904J- and whose ROM-based firmware is revision 2.00.

With the changes described in Appendix A, this manual also applies to instruments whose ROM-based firmware is version 1.02 and below.

For additional important information about serial numbers, read SERIAL NUMBER in Section 7 of this Operation Manual.

© COPYRIGHT: YOKOGAWA-HEWLETT-PACKARD,LTD.,1987
9-1, TAKAKURA-CHO, HACHIOJI-SHI, TOKYO, JAPAN

Manual Part Number: 04195-90000
Microfiche Part Number: 04195-90050

Printed: July 1989

Notice

Hewlett-Packard to Agilent Technologies Transition

This manual may contain references to HP or Hewlett-Packard. Please note that Hewlett-Packard's former test and measurement, semiconductor products and chemical analysis businesses are now part of Agilent Technologies. To reduce potential confusion, the only change to product numbers and names has been in the company name prefix: where a product name/number was HP XXXX the current name/number is now Agilent XXXX. For example, model number HP8648 is now model number Agilent 8648.

Contacting Agilent Sales and Service Offices

The sales and service contact information in this manual may be out of date. The latest service and contact information for your location can be found on the Web at:

<http://www.agilent.com/find/assist>

If you do not have access to the Internet, contact your field engineer or the nearest sales and service office listed below. In any correspondence or telephone conversation, refer to your instrument by its model number and full serial number.

United States

(tel) 1 800 452 4844
(fax) 1 800 829 4433

Canada

(tel) +1 877 894 4414
(fax) +1 888 900 8921

Europe

(tel) (31 20) 547 2323
(fax) (31 20) 547 2390

Latin America

(tel) (305) 269 7500
(fax) (305) 269 7599

Japan

(tel) (81) 426 56 7832
(fax) (81) 426 56 7840

Australia

(tel) 1 800 629 485
(fax) (61 3) 9210 5947

New Zealand

(tel) 0 800 738 378
(fax) 64 4 495 8950

Asia Pacific

(tel) (852) 3197 7777
(fax) (852) 2506 9284



Agilent Technologies

MANUAL PRINTING HISTORY

October 1987	First Edition	This manual is the first edition Operation Manual for HP 4195A Network/Spectrum Analyzer. (Excluding Appendix G "Index".)
February 1988	Second Edition	Adds Appendix G "Index". Revision for changing ROM-based firm-ware from version 1.00 to 1.01.
July 1989	Third Edition	Revision for changing ROM-based firm-ware from version 1.02 to 2.00.

Notice

Hewlett-Packard to Agilent Technologies Transition

This manual may contain references to HP or Hewlett-Packard. Please note that Hewlett-Packard's former test and measurement, semiconductor products and chemical analysis businesses are now part of Agilent Technologies. To reduce potential confusion, the only change to product numbers and names has been in the company name prefix: where a product name/number was HP XXXX the current name/number is now Agilent XXXX. For example, model number HP8648 is now model number Agilent 8648.

Contacting Agilent Sales and Service Offices

The sales and service contact information in this manual may be out of date. The latest service and contact information for your location can be found on the Web at:

<http://www.agilent.com/find/assist>

If you do not have access to the Internet, contact your field engineer or the nearest sales and service office listed below. In any correspondence or telephone conversation, refer to your instrument by its model number and full serial number.

United States

(tel) 1 800 452 4844

(fax) 1 800 829 4433

Canada

(tel) +1 877 894 4414

(fax) +1 888 900 8921

Europe

(tel) (31 20) 547 2323

(fax) (31 20) 547 2390

Latin America

(tel) (305) 269 7500

(fax) (305) 269 7599

Japan

(tel) (81) 426 56 7832

(fax) (81) 426 56 7840

Australia

(tel) 1 800 629 485

(fax) (61 3) 9210 5947

New Zealand

(tel) 0 800 738 378

(fax) 64 4 495 8950

Asia Pacific

(tel) (852) 3197 7777

(fax) (852) 2506 9284



Agilent Technologies

HOW TO USE THIS MANUAL

This is the Operation Manual for HP Model 4195A Network/Spectrum Analyzer. This manual contains seven sections plus appendices, organized for the convenience of the first time user. After you receive your HP 4195A, begin with Section 1. If you are a first time user of an already installed 4195A, begin with Section 2. The performance test and adjustment procedures are described in the HP 4195A's maintenance manual.

Section 1, Getting Started

Section 1 includes unpacking, initial inspection, and preparation information necessary for you to know before you apply AC power. Read Section 1 before apply AC power to the 4195A.

Section 2, Product Overview

Section 2 includes information which will be necessary before operating your 4195A. Reading this section before operating the 4195A will help you to operate the 4195A more efficiently.

Section 3, Basic Measurement Examples

Section 3 includes basic measurement examples. Perform the procedures given in this section in order to familiarize yourself with the 4195A.

Section 4, Measurement Capabilities

Section 4 describes the 4195A's basic measurement capabilities.

Section 5, Extended Capabilities

Section 5 describes the 4195A's extended capabilities (flexible disc, Equivalent Circuit Analysis, USER Math, Program Point Measurement, Hardcopy, etc.).

Section 6, Programming

Section 6 includes information on automating measurement (User Defined Functions, User Programs and HP-IB programming).

Section 7, General Information

Section 7 includes the specifications, rack mount/handle kit installation, and other general information on the 4195A.

Appendices

Appendix **A** is the **Manual Backdating** and provides information to use this manual with a 4195A which was manufactured before the printing date of the manual. Appendices **B** through **G** are lists that will be often used. Appendix **H** and **I** are front and rear panel illustrations. The front panel illustration is a convenient foldout page for you to refer to while reading this manual.

CERTIFICATION

Hewlett-Packard Company certifies that this product met its published specifications at the time of shipment from the factory. Hewlett-Packard further certifies that its calibration measurements are traceable to the United States National Bureau of Standards, to the extent allowed by the Bureau's calibration facility, or to the calibration facilities of other International Standards Organization members.

WARRANTY

This Hewlett-Packard instrument product is warranted against defects in material and workmanship for a period of one year from the date of shipment, except that in the case of certain components listed in Section 7 of this manual, the warranty shall be for the specified period. During the warranty period, Hewlett-Packard Company will, at its option, either repair or replace products which prove to be defective.

For warranty service or repair, this product must be returned to a service facility designated by HP. Buyer shall prepay shipping charges to HP and HP shall pay shipping charges to return the product to Buyer. However, Buyer shall pay all shipping charges, duties, and taxes for products returned to HP from another country.

HP warrants that its software and firmware designated by HP for use with an instrument will execute its programming instruction when properly installed on that instrument. HP does not warrant that the operation of the instrument, or software, or firmware will be uninterrupted or error free.

LIMITATION OF WARRANTY

The foregoing warranty shall not apply to defects resulting from improper or inadequate maintenance by Buyer, Buyer-supplied software or interfacing, unauthorized modification or misuse, operation outside of the environment specifications for the product, or improper site preparation or maintenance.

NO OTHER WARRANTY IS EXPRESSED OR IMPLIED. HP SPECIFICALLY DISCLAIMS THE IMPLIED WARRANTIES OF MERCHANTABILITY AND FITNESS FOR A PARTICULAR PURPOSE.

EXCLUSIVE REMEDIES

THE REMEDIES PROVIDED HEREIN ARE BUYER'S SOLE AND EXCLUSIVE REMEDIES. HP SHALL NOT BE LIABLE FOR ANY DIRECT, INDIRECT, SPECIAL, TRACT, TORT, OR ANY OTHER LEGAL THEORY.

ASSISTANCE

Product maintenance agreements and other customer assistance agreements are available for Hewlett-Packard products.

For any assistance, contact your nearest Hewlett-Packard Sales and Service Office. Address are provided at the back of this manual.

SAFETY SUMMARY

The following general safety precautions must be observed during all phases of operation, service, and repair of this instrument. Failure to comply with these precautions or with specific **WARNINGS** given elsewhere in this manual violates safety standards of design, manufacture, and intended use of the instrument. **The Hewlett-Packard Company assumes no liability for the customer's failure to comply with these requirements.**

GROUND THE INSTRUMENT

To minimize shock hazards, the instrument chassis and cabinet must be connected to an electrical ground. The instrument is equipped with a three-conductor AC power cable. The power cable must either be plugged into an approved three-contact electrical outlet or used with a three-contact to two-contact adapter with the grounding wire (**green**) firmly connected to an electrical ground (safety ground) at the power outlet. The power jack and the mating plug of the power cable meet International Electrotechnical Commission (IEC) safety standards.

DO NOT OPERATE IN AN EXPLOSIVE ATMOSPHERE

Do not operate the instrument in the presence of flammable gasses or fumes. Operation of any electrical instrument in such an environment constitutes a safety hazard.

KEEP AWAY FROM LIVE CIRCUITS

Operating personnel must not remove instrument covers. Component replacement and internal adjustments must be made by qualified maintenance personnel. Do not replace components with power cable connected. Under certain conditions, dangerous voltages may exist even with the power cable removed. To avoid injuries, always disconnect power and discharge circuits before touching them.

DO NOT SERVICE OR ADJUST ALONE

Do not attempt internal service or adjustment unless another person, capable of rendering first aid and resuscitation, is present.

USE CAUTION WHEN EXPOSING OR HANDLING THE CRT

Breakage of the cathode-ray tube (CRT) causes a high velocity scattering of glass fragments (implosion). To prevent CRT implosion, avoid rough handling or jarring of the instrument. Handling of the CRT shall be done only by qualified maintenance personnel using approved safety mask and gloves.

DO NOT SUBSTITUTE PARTS OR MODIFY INSTRUMENT

Because of the danger of introducing additional hazards, do not substitute parts or perform any unauthorized modification to the instrument. Return the instrument to a Hewlett-Packard Sales and Service Office for service and repair to ensure that safety features are maintained.

DANGEROUS PROCEDURE WARNINGS

WARNINGS, such as the example below, precede potentially dangerous procedures throughout this manual. Instructions contained in the warnings must be followed.

WARNING

DANGEROUS VOLTAGES, CAPABLE OF CAUSING DEATH, ARE PRESENT IN THIS INSTRUMENT. USE EXTREME CAUTION WHEN HANDLING, TESTING, AND ADJUSTING THIS INSTRUMENT.

SAFETY SYMBOLS

General Definitions of Safety Symbols Used On Equipment or In Manuals.



Instruction manual symbol: the product will be marked with this symbol when it is necessary for the user to refer to the instruction manual in order to protect against damage to the instrument.



Indicates dangerous voltage (terminals fed from the interior by voltage exceeding 1000 volts must be so marked).

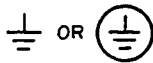

Protective conductor terminal. For protection against electrical shock in case of a fault. Used with wiring terminals to indicate the terminal which must be connected to ground before operating equipment.



Low-noise or noiseless, clean ground (earth) terminal. Used for a signal common, as well as providing protection against electrical shock in case of fault. A terminal marked with this symbol must be connected to ground in the manner described in the installation (Operating) manual, and before operating the equipment.

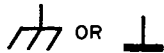

Frame or chassis terminal. A connection to the frame (chassis) of the equipment which normally includes all exposed metal structures.



Alternating current (power line).



Direct current (power line).



Alternating or direct current (power line).



A **WARNING** denotes a hazard. It calls attention to a procedure, practice, condition or the like, which, if not correctly performed or adhered to, could result in injury or death to personnel.



A **CAUTION** sign denotes a hazard. It calls attention to a procedure, practice, condition or the like, which, if not correctly performed or adhered to, could result damage to or destruction of part or all of the product.

NOTE

A **NOTE** denotes important information. It calls attention to a procedure, practice, condition or the like, which is essential to highlight.

TABLE OF CONTENTS

Section 1 Getting Started

1-1. Introduction	1-1
1-2. Incoming Inspection	1-1
1-3. Preparation for Use	1-2
1-3-1. Upper/Lower Unit Linking/Controlling	1-2
1-3-2. Power Requirements	1-3
1-3-3. Line Voltage and Fuse Selection	1-3
1-3-4. Power Cable	1-4
1-4. Operation Environment	1-5

Section 2 Product Overview

2-1. Introduction	2-1
2-2. Product Introduction	2-1
2-3. A Tour of the Front Panel	2-2
2-4. A Tour of the Rear Panel	2-7
2-5. CRT Display Area Definition	2-8

Section 3 Basic Measurement Examples

3-1. Introduction Example	3-1
3-2. Network Measurement Example	3-2
3-3. Spectrum Measurement Example	3-5
3-4. Impedance Measurement Example	3-7
3-5. S-Parameter Measurement Example	3-12

Section 4 Measurement Capabilities

4-1. Introduction	4-1
4-2. General Measurement Information	4-1
4-3. Measurement Configuration	4-2
4-4. Network Configuration	4-3
4-4-1. Network Configuration Port Selection	4-3
4-4-2. Network Configuration Measurement Parameters	4-3
4-4-3. Group Delay Measurement	4-4
4-4-4. Network Measurement Calibration	4-7
4-5. Spectrum Configuration	4-11
4-5-1. Measurement Units for the Spectrum Configuration	4-11
4-5-2. Input Connectors	4-13
4-5-3. Built-in Tracking Generator	4-13
4-6. Impedance Configuration	4-14
4-6-1. Impedance Measurement Parameters	4-14
4-6-2. Port Selection	4-15
4-6-3. Test Signal Level	4-16
4-6-4. Calibration and Compensation of the Impedance Configuration	4-16
4-7. S-Parameter Configuration	4-17
4-8. Measurement Calibration	4-18
4-8-1. Transmission Calibration	4-19
4-8-2. Reflection Calibration	4-20
4-8-3. Calibration Standard Values	4-22
4-8-4. $0S/0\Omega$ Offset Compensation	4-23
4-8-5. Port Extension	4-23
4-8-6. Calibration Hints	4-24
4-9. Stimulus Settings	4-27
4-9-1. Selecting Sweep Parameter	4-27
4-9-2. Specifying the Sweep Range	4-27
4-9-3. Selection Sweep Type	4-28
4-9-4. Number of Measurement Points	4-28
4-9-5. Sweep Time	4-29
4-9-6. Non-sweep Parameters	4-29
4-10. Receiver Settings	4-30
4-10-1. Input Range	4-30
4-10-2. Resolution Bandwidth	4-31
4-10-3. Video Filter	4-32
4-11. Measurement Triggering	4-33
4-11-1. Sweep Trigger Mode	4-33
4-11-2. Single Point Trigger Mode	4-33
4-11-3. External Triggering	4-34

4-12. Measurement Data Display	4-35
4-12-1. Measurement Data Storage	4-35
4-12-2. Display Format	4-35
4-12-3. Display Control Key/Softkeys	4-36
4-12-4. Changing the Display Format	4-36
4-12-5. Selecting the Display Data	4-37
4-12-6. Setting the Grid Scale	4-37
4-12-7. Setting the Grid Range	4-38
4-12-8. Superimpose Subtrace C, D	4-40
4-12-9. Storage Function	4-41
4-12-10. Phase Data Expansion	4-41
4-13. Measured Data Read Out/Analysis (MARKER/LINE CURSOR)	4-42
4-13-1. Marker/Line Cursor Modes	4-42
4-13-2. Marker Area	4-43
4-13-3. Changing the Marker/Line Cursor Mode	4-43
4-13-4. Changing the Data Display Format	4-43
4-13-5. Moving the Marker/Line Cursor	4-47
4-13-6. Setting the Sweep and Grid Range	4-50
4-14. Initial Settings	4-51
4-14-1. Initial Function Settings	4-52
4-14-2. Default Value of Single Variable Registers	4-55
4-14-3. Default Value of Array Variable	4-56
4-15. Battery Back-Up Memory	4-57
4-15-1. Data Stored in the Battery Back-Up Memory	4-57
4-15-2. Battery Back-Up Specifications	4-57
4-16. Synchronizing With Other Instruments	4-58
4-16-1. External Reference Signal Input	4-58
4-16-2. Reference Signal Output	4-58

Section 5 Extended Capabilities

5-1. Introduction	5-1
5-2. Internal Registers	5-1
5-2-1. Array Registers	5-1
5-2-2. Multiple Registers	5-3
5-2-3. Single Registers	5-3
5-3. Math Operation	5-4
5-3-1. General Math Operators	5-5
5-3-2. Trigonometric Operators	5-9
5-3-3. Binary Operators	5-10
5-3-4. Other Operators	5-11
5-3-5. Math Hierarchy	5-12
5-4. Complex Matrix Operation	5-13
5-5. Angle Mode	5-13
5-6. Keyboard Execution	5-14

Table of Contents

5-7. Suffixes	5-14
5-7-1. Engineering Notation	5-14
5-7-2. Engineering Units	5-15
5-8. Special Characters	5-15
5-9. User Math	5-17
5-9-1. Define Calculation	5-17
5-9-2. Entering the Parameter and Unit Labels	5-17
5-9-3. How to Activate the Define Math Capability	5-18
5-9-4. Example	5-19
5-10. Partial Sweep	5-20
5-10-1. Storing the Partial Sweep Range	5-20
5-10-2. Activate Partial Sweep	5-20
5-11. Partial Analysis	5-21
5-11-1. Storing the Partial Analysis Range	5-21
5-11-2. Selecting Partial Analysis	5-21
5-12. Programmed Points Measurement	5-23
5-12-1. Programmed Points Table	5-23
5-12-2. Set the Programmed Points Table	5-23
5-12-3. Programmed Points Table Set Up Procedure	5-25
5-12-4. Programmed Points Measurement Procedure	5-27
5-12-5. How to Print the Programmed Points Table	5-28
5-13. Hard Copy	5-29
5-13-1. Copying Capabilities	5-29
5-13-2. How to Make a Hard Copy	5-30
5-13-3. Recommended Plotters and Printer	5-30
5-13-4. Plot Mode	5-31
5-13-5. Copy Procedure	5-33
5-13-6. Plot Pen Selection	5-34
5-14. Equivalent Circuit Function	5-36
5-14-1. How to Enter the Equivalent Circuit Analysis Mode	5-36
5-14-2. How to Select the Equivalent Circuit Model	5-36
5-14-3. How to Calculate the Equivalent Circuit Parameters	5-38
5-14-4. How to Simulate the Frequency Characteristics	5-38
5-15. 8-Bit Input/Output	5-39
5-15-1. 8-Bit Input	5-39
5-15-2. 8-Bit Output	5-41
5-15-3. Output Timing	5-42
5-16. Display Characteristics/Register Data on the CRT	5-43
5-16-1. CMT Command	5-43
5-16-2. Disp Command	5-43
5-17. Using Active Probes	5-44

5-18. Mass Storage	5-45
5-18-1. Saved Instrument Settings	5-45
5-18-2. Saving a Programmed Point Table	5-45
5-18-3. Saving Register Data	5-45
5-18-4. Saving User Programs	5-46
5-18-5. Built-in Disc Drive	5-46
5-18-6. Usable Discs	5-46
5-18-7. What is a Flexible Disc?	5-47
5-18-8. A Look at a Flexible Disc	5-47
5-18-9. Loading the Flexible Disc	5-48
5-18-10. Formatting (Initializing)	5-49
5-18-11. Storing Data	5-50
5-18-12. Displaying the File Catalog	5-50
5-18-13. Retrieving Data	5-50
5-18-14. Purging a File	5-51
5-18-15. Recovering a File	5-51
5-18-16. Disc Capacity	5-51
5-18-17. Write Protect Tab	5-52
5-18-18. Labeling a Flexible Disc	5-53
5-18-19. Handling Micro Flexible Disc	5-53
5-18-20. Making Back Up Copies	5-54
5-18-21. Editing a Saved File Using a Desk-Top Computer	5-54

Section 6 Programming

6-1. Introduction	6-1
6-2. Command Syntax	6-1
6-2-1. Header Only Type	6-2
6-2-2. Numeric Data Type	6-2
6-2-3. Multiple Numeric Data Type	6-2
6-2-4. String Data Type	6-2
6-2-5. Select Type	6-2
6-2-6. Others	6-2
6-3. User Defined/Sweep End Functions	6-5
6-3-1. Softkey/Command for the User Defined/Sweep End Function	6-5
6-3-2. Perform User Defined Function/Sweep End Function	6-5
6-3-3. Define User Defined Function/Sweep End Function	6-6
6-3-4. Exit User Defined Function/Sweep End Function	6-6
6-3-5. Labeling a Defined Softkey	6-7
6-3-6. Using Example	6-8
6-4. User Program (Auto Sequence Program: ASP)	6-12
6-4-1. Commands Usable in ASP Programs	6-12
6-4-2. HP 4195A BASIC Statements	6-13
6-4-3. Program Control Commands	6-18
6-4-4. How to Edit a User Program (ASP)	6-20
6-4-5. Editing Hints	6-22
6-4-6. How to Execute a User Program (ASP)	6-27
6-4-7. Program Start Connector	6-28
6-4-8. How to Make a Hard Copy Program Listing	6-29
6-4-9. Sample Programs	6-29

Table of Contents

6-5. HP-IB	6-34
6-5-1. 4194A's HP-IB Capability	6-34
6-5-2. HP-IB Definition	6-35
6-5-3. 4195A's HP-IB Commands	6-36
6-5-4. How to Output Register Data	6-40
6-5-5. Data Output Formats	6-41
6-5-6. Data Transfer Rate	6-46
6-5-7. Status Byte	6-47
6-5-8. Sending Characters by HP-IB	6-50
6-5-9. HP-IB Interface Restrictions	6-50
6-5-10. Program Examples	6-53

Section 7 General Information

7-1. Introduction	7-1
7-2. Components not Covered by Warranty	7-1
7-3. Safety Considerations	7-1
7-4. Serial Number	7-1
7-5. Specifications	7-2
7-6. Rack/Handle Installation	7-2
7-6-1. Front Handle Kit	7-3
7-6-2. Rack Flange Kit and Rack & Handle Kit	7-4
7-7. Bottom Feet/Tilt Stand	7-5
7-8. Storage/Repacking	7-5
7-8-1. Environment	7-5
7-8-2. Original Packaging	7-5
7-8-3. Other Packaging	7-6
Appendix A Manual Back Dating	A-1
Appendix B Error Messages and Instructions	B-1
Appendix C Error Numbers	C-1
Appendix D Softkey Tree	D-1
Appendix E Command List	E-1
Appendix F Register List	F-1
Appendix G Index	G-1
Appendix H Blue/Green Shift Keys	H-1

LIST OF TABLES

Section 1. Receiving and Getting Ready To Use Your 4195A	
No Tables	
Section 2. Product Overview	
No Tables	
Section 3. Basic Measurement Examples	
No Tables	
Section 4. Measurement Capabilities	
4-1. Network Configuration Port Selection	4-3
4-2. Spectrum Measurement Units	4-11
4-3. Input Connector Selection	4-13
4-4. Output Connector Selection	4-13
4-5. Impedance Measurement Parameter Combinations	4-14
4-6. Purpose and Use of Transmission Calibration Types	4-19
4-7. Purpose and Use of Reflection Calibration Types	4-20
4-8. Sweep Parameter Selection	4-27
4-9. Sweep Parameter Settable Range	4-27
4-10. Spectrum Configuration Input Ranges	4-30
4-11. Input Ranges for other than Spectrum Configuration	4-30
4-12. IF Range Selection	4-31
4-13. Input Attenuators	4-31
4-14. Resolution Bandwidth AUTO Selection	4-32
4-15. Initialization Differences	4-51
4-16. Initial Setting for General Parameter	4-52
Section 5. Extended Capabilities	
5-1. Math Operators	5-4
5-2. Math Hierarchy	5-12
5-3. Engineering Notation	5-14
5-4. 4195A Special Characters	5-16
5-5. Capabilities of Three Copy Modes	5-29
5-6. Recommended Plotters and Printers	5-30
5-7. Plot Pen Selection	5-34
5-8. Equivalent Circuit Model Selection Guide	5-37
5-9. Stored Data Length	5-52
Section 6. Programming	
6-1. Command Syntax Diagram	6-3
6-2. Procedure to Define the User Defined Function 1	6-9
6-3. Procedure to Define the User Defined Function 2	6-10
6-4. Procedure to Define the User Defined Function 3	6-11
6-5. ASP Editing Example	6-21
6-6. HP-IB Interface Capability	6-34
6-7. Data Transfer Rate	6-46
6-8. Status Byte Assignments	6-47
Section 7. General Information	
7-1. Specifications	7-7
7-2. Options	7-21
7-3. Furnished Accessories	7-21
7-4. Available Accessories	7-22
7-5. Accessories Selection Guide for Network Measurement	7-28

LIST OF ILLUSTRATIONS

Section 1. Getting Started	
1-1. HP 4195A and Furnished Accessories	1-1
1-2. Cable Interconnections	1-3
1-3. Line Voltage and Fuse Selection	1-4
1-4. Power Cables Supplied	1-6
Section 2. Product Overview	
2-1. CRT Display Area Definition	2-8
Section 3. Basic Measurement Examples	
3-1. Network Measurement Example Setup	3-3
3-2. Spectrum Measurement Example Setup	3-6
3-3. Impedance Test Adapter Connection	3-7
3-4. Test Fixture Connection	3-10
3-5. Attachment Connection	3-10
3-6. S-Parameter Configuration Setup Example	3-12
Section 4. Measurement Capabilities	
4-1. Relationship of Factors	4-5
4-2. Transmission Calibration Diagram	4-7
4-3. Reflection Calibration Diagram	4-8
4-4. Typical S-Parameter Setup	4-17
4-5. 0S/0 Ω Offset Compensation	4-23
4-6. Input T1 Port Extension Example	4-23
4-7. Port 1 Extension Example	4-24
4-8. External Trigger Pulse	4-34
4-9. Grid Range	4-38
4-10. Smith Chart Grid Range	4-39
4-11. Superimpose Subtraces C and D	4-41
4-12. Marker Area Location	4-43
4-13. MKR \rightarrow MAX, MIN, LCURS \rightarrow AVRG and NEXT PEAK	4-48
Section 5. Extended Capabilities	
5-1. Partial Sweep Range	5-20
5-2. Partial Analysis Range	5-21
5-3. Plot Area	5-31
5-4. P1, P2 Normal and Graticule	5-32
5-5. 8-Bit I/O Connector	5-39
5-6. 8-Bit Input Port Equivalent Circuit	5-39
5-7. 8-Bit Output Port Equivalent Circuit	5-41
5-8. EOS and EOM Output Timing (Typical)	5-42
5-9. Probe Power Jack	5-44
5-10. Built-in Disc Drive	5-46
5-11. Parts of the Flexible Disc	5-47
5-12. Proper Loading of the Flexible Disc	5-48
5-13. Write Protect Tab	5-52
5-14. Disc Label Position	5-53
5-15. Register Data Editing Sample Program	5-56
Section 6. Programming	
6-1. Examples of the "SWTRG" Command	6-22
6-2. Input Pulse	6-28
6-3. Typical HP-IB System Interconnection	6-51
6-4. HP-IB Interfacing	6-52

Section 7. General Information

- 7-1. Serial Number Plate
- 7-2. Rack Mount Kits

7-1
7-3

NOTES

SECTION 1

GETTING STARTED

1-1. INTRODUCTION

This section provides the information necessary for receiving, performing an incoming inspection, preparing for use, and setting up your HP 4195A.

The **WARNINGS**, **CAUTIONS**, and **NOTES** given throughout this document must be carefully followed to ensure the operator's safety and to maintain the 4195A's serviceability.

1-2. INCOMING INSPECTION

This instrument has been carefully inspected both electrically and mechanically before being shipped from the factory. It should be in perfect condition, no scratches, dents or the like, and it should be in perfect electrical condition. To verify this, carefully perform an incoming inspection to check the instrument for signs of physical damage, missing contents, or if this instrument does not pass the electrical performance test as follows and if any discrepancy is found, notify the carrier and Hewlett-Packard. The HP sales office will arrange for repair and replacement without waiting for the claim to be settled.

1. Inspect the shipping container for damage, and keep the shipping materials until the inspection is completed.
2. Verify that the shipping container contains everything shown in Figure 1-1.

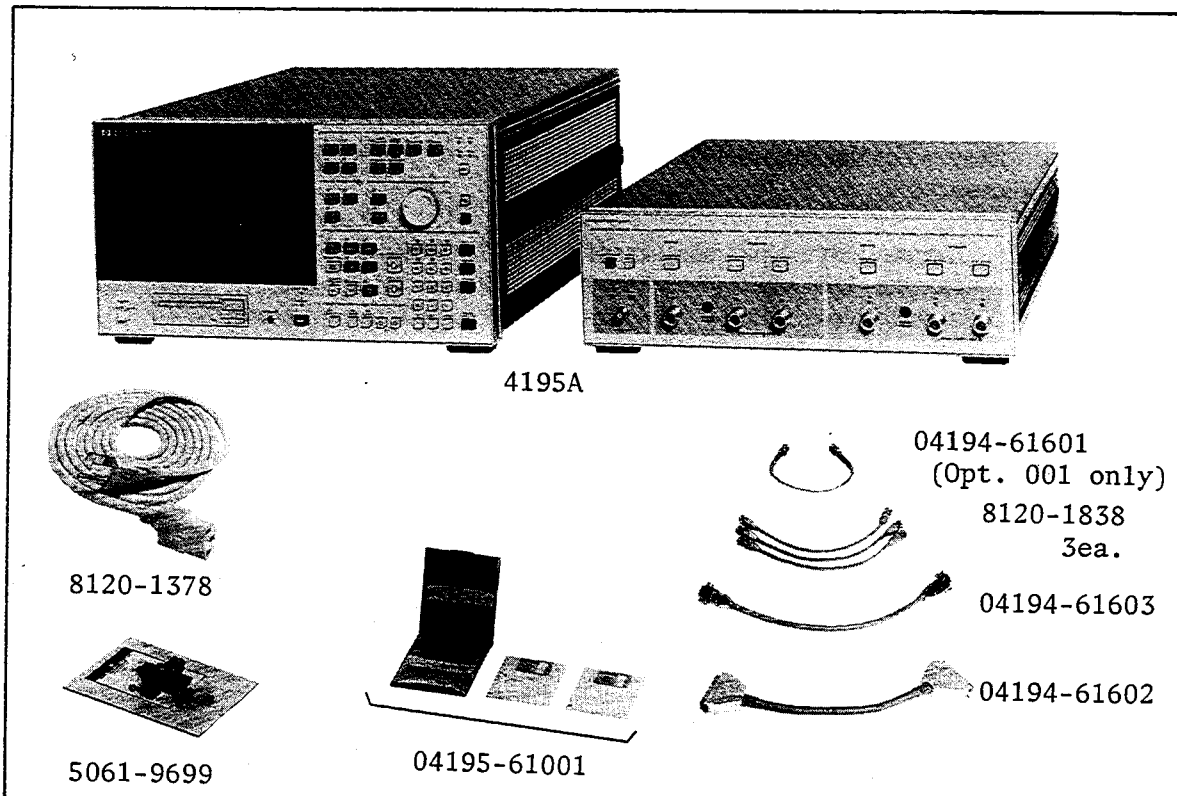

Figure 1-1. HP 4195A and Furnished Accessories

3. Inspect the exterior of the 4195A for any signs of damage.
4. Verify that the 4195A is equipped with the Options you ordered.
5. Complete the **PREPARATION FOR USE** procedures described in paragraph 1-3.
6. Perform the **Performance Test** described in the Maintenance Manual to verify the 4195A's electrical performance.

1-3. PREPARATION FOR USE

1-3-1. UPPER/LOWER UNIT LINKING/CONTROLLING

1. Interconnecting Units

The 4195A consists of two modules which must be electrically and mechanically interconnected using the supplied cables and Rear Panel Lock Foot Kit (Full Modules, PN 5061-9699) to facilitate handling and to allow proper connection between the two units. The procedure for mounting the control unit on top of the measurement unit is as follows.

1. Remove the feet from the bottom cover of the Control Unit by:
 - (1) Lifting the tab of the bottom foot.
 - (2) Sliding the bottom foot in the direction of the tab.
2. Install the Rear Panel Lock Foot Kit. Follow the instructions provided with the kit. Once the kit has been installed, the two units will be firmly secured to each other allowing you to pick up the 4195A without having to disconnect the rear cables.

2. Interconnection Cables

Connect the following cables between the rear panels of the control and measurement units as shown in Figure 1-2.

- | | |
|------------|---|
| Cable (1). | Connect the 9-pin cable assembly (PN 04194-61603) between J6 of the Control Unit and J6 of the Measurement Unit. Use a small standard screwdriver to tighten the screws on the cable connectors. |
| Cable (2). | Connect the 50-pin cable assembly (PN 04194-61602) between J5 of the Control Unit and J5 of the Measurement Unit. Lock the cable connectors with the spring clips. |
| Cable (3). | Connect three BNC cables (PN 8120-1838) between J2, J3, and J4 of the Control and Measurement Units. |
| Cable (4). | Option 001 equipped instruments only. Connect a BNC cable (PN 04194-61601) between the 'EXT REFERENCE' connector on the Control Unit and the 'REFERENCE OVEN' connector on the Measurement Unit. |

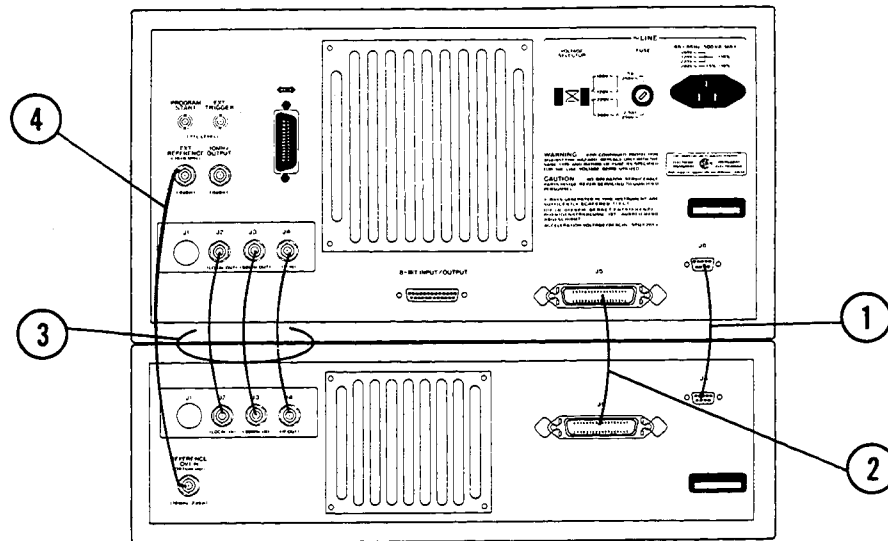

Figure 1-2. Cable Interconnections

1-3-2. POWER REQUIREMENTS

The 4195A requires an AC power source of 100, 120, 220 V $\pm 10\%$, or 240 V $+5\%$ -10% , 48 to 66 Hz single phase, power consumption is 500 VA maximum.

WARNING

THIS IS A SAFETY CLASS 1 PRODUCT (PROVIDED WITH A PROTECTIVE EARTH TERMINAL). A NONINTERRUPTABLE SAFETY EARTH GROUND MUST BE PROVIDED FROM THE MAINTAIN POWER SOURCE TO THE INSTRUMENT'S POWER INPUT TERMINALS, POWER CORD, OR SUPPLIED POWER CORD SET. WHENEVER THE SAFETY EARTH GROUNDED HAS BEEN IMPAIRED, THE INSTRUMENT MUST BE MADE INOPERATIVE AND SECURED AGAINST ANY UNINTENDED OPERATION. IF THIS INSTRUMENT IS TO BE ENERGIZED VIA AN AUTOTRANSFORMER (NOT RECOMMENDED) FOR VOLTAGE REDUCTION, MAKE SURE THAT THE COMMON TERMINAL IS CONNECTED TO THE EARTH POLE OF THE POWER SOURCE.

1-3-3. LINE VOLTAGE AND FUSE SELECTION

CAUTION

Before connecting the instrument to the power source, make sure that the correct fuse has been installed and the Line Voltage Selection Switch is correctly set.

Figure 1-3 illustrates the line voltage selection switch and fuse-holder on the instrument's rear-panel, instructions for line voltage and fuse selection, and the line voltage range for line voltage selection. Current ratings for the fuse are printed under the fuse-holder on the rear-panel and are listed, along with the fuse's HP part number, in Figure 1-3.

CAUTION

Use the proper fuse for the line voltage selected. Make sure that only fuses with the required current rating and of the specified type are used as replacements. **DO NOT** use a mended fuse or short-circuit the fuse-holder in order to by-pass the fuse.

100V Operation

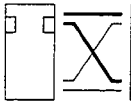

100V~
120V~
220V~
240V~

120V Operation

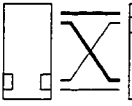

100V~
120V~
220V~
240V~

220V Operation

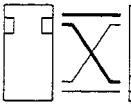

100V~
120V~
220V~
240V~

240V Operation

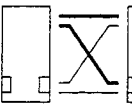

100V~
120V~
220V~
240V~

Line Voltage Selection

Voltage Selector	Line Voltage
100V	90 - 110V, 48 - 66Hz
120V	108 - 132V, 48 - 66Hz
220V	198 - 242V, 48 - 66Hz
240V	216 - 252V, 48 - 66Hz

Line Voltage Selector:

Set the Line Voltage Selector switch.

Fuse Removal:

Turn the fuse holder counterclockwise until the fuse pops out.

Fuse Selection

Operating Voltage	Fuse Rating	Fuse Part No.
100V 120V	5A, 250V, Normal Blow	2110-0010
220V 240V	3A, 250V, Slow Blow	2110-0381

Figure 1-3. Line Voltage and Fuse Selection

1-3-4. POWER CABLE

To protect operating personnel, the National Electrical Manufacturer's Association (NEMA) recommends that the instrument panel and cabinet be grounded. The 4195A is equipped with a three-conductor power cable, which, when plugged into an appropriate AC power receptacle, grounds the instrument. The offset pin on the power cable is the ground wire.

To preserve the protection feature when operating the instrument from a two contact outlet, use a three-prong to two-prong adapter (PN 1251-8196) and connect the adapter's green pigtail to power-line ground.

CAUTION

The power plug must be inserted into an outlet that provides a protective earth connection. You must not use an extension cord or power cable without a protective conductor (ground).

Figure 1-4 shows the power cords used in various countries. Also shown is the standard power cord furnished with the instrument. HP Part Numbers, applicable standards for power plugs, electrical characteristics, and the countries using each power cord are listed in Figure 1-4. For assistance in selecting the correct power cable, contact the nearest Hewlett-Packard sales office.

1-4. OPERATION ENVIRONMENT

The 4195A must be operated under within the following environment conditions, and sufficient space must be kept behind the 4195A to avoid obstructing the air flow of the cooling fans.

Temperature: 0°C to 55°C

Humidity: less than 95% RH at 40°C

NOTE

The 4195A must be protected from temperature extremes which could cause condensation within the instrument.

<p>OPTION 900 United Kingdom</p>  <p>Plug: BS 1363A, 250V Cable: HP 8120-1351</p>	<p>OPTION 901 Australia/New Zealand</p>  <p>Plug: NZSS 198/AS C112, 250V Cable: HP 8120-1369</p>
<p>OPTION 902 European Continent</p>  <p>Plug: CEE-VII, 250V Cable: HP 8120-1689</p>	<p>OPTION 903 U.S./Canada</p>  <p>Plug: NEMA 5-15P, 125V, 15A Cable: HP 8120-1378</p>
<p>OPTION 904 U.S./Canada</p>  <p>Plug: NEMA 6-15P, 250V, 15A Cable: HP 8120-0698</p>	<p>OPTION 905* Any country</p>  <p>Plug: CEE 22-VI, 250V Cable: HP 8120-1396</p>
<p>OPTION 906 Switzerland</p>  <p>Plug: SEV 1011.1959-24507 Type 12, 250V Cable: HP 8120-2104</p>	<p>OPTION 912 Denmark</p>  <p>Plug: DHCR 107, 220V Cable: HP 8120-2956</p>
<p>OPTION 917 India/Republic of S.Africa</p>  <p>Plug: SABS 164, 250V Cable: HP 8120-4211</p>	<p>OPTION 918 Japan</p>  <p>Plug: JIS C 8303, 125V, 15A Cable: HP 8120-4753</p>
<p>NOTE: Each option number includes a 'family' of cords and connectors of various materials and plug body configurations (straight, 90° etc.).</p> <p>* Plug option 905 is frequently used for interconnecting system components and peripherals.</p>	

Figure 1-4. Power Cables Supplied

SECTION 2

PRODUCT OVERVIEW

2-1. INTRODUCTION

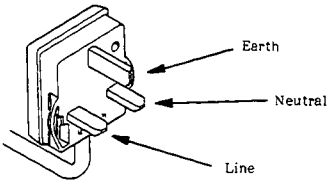
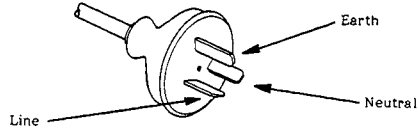
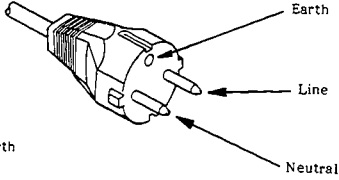
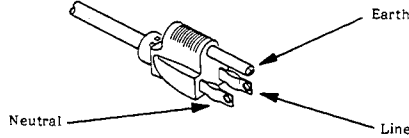
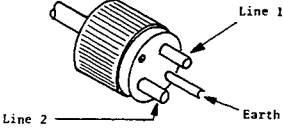
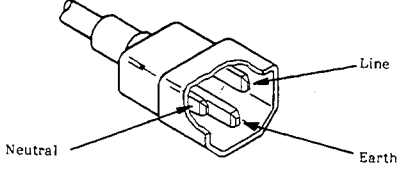
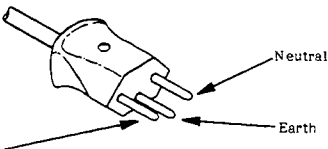
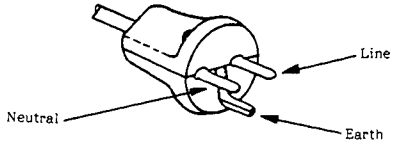
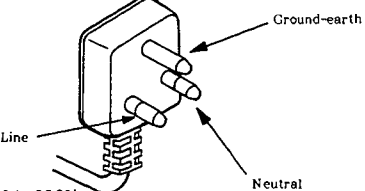
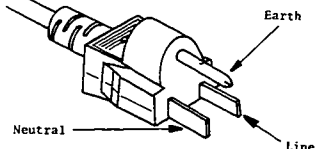
This section contains the information you need to know before operating the Hewlett-Packard Model 4195A Network/Spectrum Analyzer. Before using the 4195A, read through this section first so you can quickly and efficiently learn how to operate the HP 4195A.

2-2. PRODUCT INTRODUCTION

The HP 4195A is an intelligent Network, Spectrum, and Impedance analyzer combined into a single instrument. This combination creates a very powerful evaluation and analysis tool for evaluating **Circuits and Components**.

The 4195A consists of a **Control Unit** and a **Measurement Unit**. The control unit is mounted on top of, and is locked to the measurement unit when in use. The control unit contains a color graphics **CRT** for displaying the measurement results, and a 3-1/2 inch micro flexible **disc drive** for storing/recalling data and internally stored user programs. The measurement unit has two channels, each of which has its own source output, reference, and test receiver input on the front panel. Using two channels allows you to setup a wide variety of network/spectrum measurement and sequentially making the measurements without disconnecting and reconnecting measurement setups.

Multiple parameters are easily identified and discriminated on the Color Graphics Display. The display scale and format are independent of the measurement circuit settings, so the scale and format can be selected to precisely observe small measurement changes.

The **USER MATH** function gives you the ability to define parameters, mathematically manipulate measurement data, and to view the results in graphic format on the color CRT. The **USER DEFINED FUNCTION** gives you the ability to perform user defined control/analysis sequences with just a single key stroke. The **USER PROGRAM** function provides you with the ability to program all operations of the 4195A for automating measurement.

The 4195A can control three test parameters: frequency, test signal amplitude, and dc bias voltage. Any one of the three test parameters can be swept while the other two parameters are held at a fixed value.

2-3. A TOUR OF THE FRONT PANEL

Appendix H contains a fold-out illustration of the 4195A's front panel for you to look at while reading this manual. Open the fold-out page of Appendix H so you can look at the front panel layout while reading the following brief description of the keys, rotary knob, connectors, etc. on the front panel. The numbers in parenthesis correspond to the numbers the front panel illustration in Appendix H.

- (1) The **LINE ON/OFF** push switch turns the 4195A on/off. This switch applies AC line power to the 4195A when set to the ON position (**in**) and removes AC line power to the 4195A when set to the OFF position (**out**).
- (2) The color **CRT** Screen displays the measurement results, measurement settings, etc.
- (3) **Softkeys** are located next to the CRT screen, and their functions (given by the softkey label) are displayed on the right hand side of the screen. A softkey is a combination of a key and the label displayed next to it at any given time.
- (4) The **TRACE** area contains three keys for selecting the display format and scale.

The **DISPLAY** Key displays the softkeys used to select the display format.

The **SCALE REF** Key displays the softkeys used to change the display scales.

The **VIEW** Key displays the softkeys used to superimpose images on the display.

- (5) The **MEASURE** area contains four keys used to select the measurement parameters.

The **CONFIG** Key displays the softkeys used to select the 4195A's measurement configuration -- Network, Spectrum, Impedance and S-Parameter (**S11**, **S21**, **S12**, **S22**) configurations.

The **FORMAT** Key displays the softkeys used to select the 4195A's measurement format (parameter or unit).

The **CAL** key displays the softkeys used to select and execute the 4195A's measurement calibration and compensation functions.

The **DEFINE MATH** Key displays the softkeys used to define and select User Math functions (user defined parameter or unit) derived using predefined functions and measured data.

- (6) The **SPECIAL FUNCTION** area contains the following six keys.

The **USER DEFINE** Key displays the softkeys used to define and execute user defined key sequences which can then be executed with a single key stroke.

The **SAVE/GET** Key displays the softkeys used in the operation of the micro flexible disc drive.

The **COPY** Key displays the softkeys used to make hard copy printouts, plots, dumps of the screen contents. The **COPY Indicator** is **ON** while hard copy data is being transferred via HP-IB.

The **MORE** Key displays the softkeys for functions of Equivalent Circuit Analysis, Partial Analysis, IF Range Selection, and HP-IB Definition.

The **PROGRAM** Key displays softkeys used to edit and run User Programs (**ASP**).

The **MATH OPERATOR** Key displays the softkeys used to enter math operations.

- (7) The **HP-IB** area includes four indicators and the **LCL** key.

The **RMT** indicator is **ON** while the 4195A is in the HP-IB remote mode. Except for the **LCL** key, the front panel keys are disabled while this indicator is **ON**.

The **LTN** indicator is **ON** while the 4195A is communicating via the HP-IB bus as a listener.

The **TLK** indicator is **ON** while the 4195A is communicating via the HP-IB bus as a talker.

The **SRQ** indicator is **ON** while the 4195A is asserting the HP-IB service request line.

The **LCL** Key is used to return the 4195A to the manual mode from the HP-IB remote mode.

- (8) The **MARKER/LINE CURSOR** area includes two keys and a knob which are used to select and read measurement data, and to search for specific measurement points.

The **MKR** → Key displays the softkeys used to move/control the marker and line cursors.

The **MODE** Key displays the softkeys used to select the marker or line cursor.

The rotary **Knob** is used to continuously move the displayed marker or line cursor.

- (9) The **Blue** shift key is used to shift a front panel key's function to its blue labeled function (alphabetical characters). When the blue shift key is pressed and active, the blue key indicator will be **ON**. For some functions the blue shift key will automatically be activated, for some functions it will stay active until pressed a second time, and for other functions it will automatically turn off to facilitate further user keyboard entries.

- (10) The **Green** shift key is used to shift front panel key functions to their **green** labeled function. This key must be pressed each time a **green** labeled key function is used, because this key is active for only one key press after the **green** shift key is pressed.

- (11) The **ENTRY** area includes number keys, and unit keys, etc. used for numeric entry.

The **Number** Keys are used to type in numbers.

The **Decimal Point (.)** Key is used to type in a decimal point.

The **Minus (-)** Key types in the minus sign.

The **Equal (=)** Key types in the equal symbol.

The **EEX** Key types in the exponent symbol (**E**) on the display.

The **SPACE** Key types in a character space.

The **MHz/V** Key adds a "MHZ" or a "V" to the value previously typed in, and terminates the input.

The **kHz/dBm** Key adds a "KHZ" or a "DBM" to the value previously typed in, and terminates the input.

The **Hz/dB μ V** Key adds a "HZ" or a "DBUV" to the value previously typed in, and terminates the input.

The **ENTER/EXECUTE** Key terminates keyboard input and executes the command.

NOTE

The MHz/V, kHz/dBm, Hz/dB μ V keys are called the unit keys in this manual.

- (12) The **Arrow (Up/Down)** Keys increment or decrement the parameter value displayed on the keyboard input line. When pressed just after the green shift key is pressed, these keys change the alpha numeric display page (such as TABLE display format, User Program (ASP) editor, file CATALOG) to the **next page** or to the **previous page**, respectively.
- (13) The **EDIT** area includes five keys that are used to edit alpha numeric keyboard input.

The **CLR LINE** Key erases the input line. When pressed just after the green key is pressed this key **recalls** the last entered/executed command on the keyboard input line.

The **DEL CHAR** Key deletes the character at the cursor position.

The **INS CHAR** Key inserts character(s), at the cursor position, between characters previously typed in. When in the insert mode, the cursor is a box instead of a bar. When not in the insert mode, the cursor is an underline.

The **Arrow (Left/Right)** Keys move the cursor left and right.

- 14) The **SWEEP** area contains nine keys to select and vary measurement parameters (conditions).

The **SWEEP** indicator is **ON** while the 4195A is performing a sweep measurement.

The **MENU** Key displays the softkeys that select the sweep parameters and sweep type, etc.

The **CENTER** Key displays the current value of the sweep center parameter on the keyboard input line, which you can then change.

The **SPAN** Key displays the current value of the sweep span parameter on the keyboard input line, which you can then change.

The **WAIT TRIG** Indicator is **ON** when the sweep mode is set to **SINGLE** sweep and the 4195A is waiting for a sweep trigger (pressing the **TRIG/RESET** key).

The **TRIG/RESET** Key restarts the sweep measurement from the starting point.

The **START** Key displays the current start value of the sweep parameter on the keyboard input line, which can then be changed.

The **STOP** Key displays the current stop value of the sweep parameter on the keyboard input line, which can then be changed.

The **VIDEO FILTER** Key turns the video filter **ON** and **OFF**, the **Indicator** is **ON** when the video filter is enabled.

The **AUTO** Key sets the automatic resolution bandwidth (**RBW**) and sweep time (**ST**) selection. The **AUTO** key indicator is **ON** when set to **AUTO**. Once **RES BW** is pressed the **AUTO** indicator turns **OFF**.

The **RES BW** Key displays the current resolution bandwidth value of the selected receiver on the keyboard input line, which can then be changed.

- (15) The **PRESET** Key sets the 4195A's controls to their preset initialization values.
- (16) The **UNLOCK** indicator turns **ON** if the 4195A is not synchronized to the external signal, or when the internal synthesizer is unlocked.
- (17) The **EXT REF** indicator turns **ON** when an external signal is applied to the **EXT REFERENCE** connector on the 4195A control unit's rear panel and the 4195A is synchronized to the external signal.
- (18) The **INTENSITY** Control adjusts the brightness of the CRT.
- (19) The 3-1/2 inch **Micro Flexible Disc Drive** stores the 4195A's internal settings, data, and programs for later recall.

- (20) The **DC SOURCE** area includes two keys, two indicators and a BNC connector.

The **OFF/ABORT** Key turns **OFF** the dc source output.

The **LEVEL** Key displays the value of the current dc source output voltage on the keyboard input line, which can then be changed.

The **CURRENT LIMIT** indicator turns **ON** when the dc source output is overloaded.

The **ON** indicator turns **ON** when a DC voltage is present at the DC output connector.

The **DC OUTPUT** BNC Connector is the output for the DC bias voltage.

- (21) Each **CHANNEL** includes three keys, three indicators, three N-type connectors and a 3-pin jack on the front panel.

The **AMPLITUDE** Keys display the current source output level value on the keyboard input line, which can then be changed.

The respective **S1/S2** indicator will turn **ON** when a signal source is connected to the **S1/S2** output connector.

The **OUTPUT S1/S2** Connectors are used to apply the test signal to the circuit or component under test.

The **PROBE POWER** Jacks supply DC power for active probes.

The **REF ATTEN** Keys display the current reference input attenuation on the keyboard input line, which can then be changed. These keys also display the **IF RANGE** selection softkey.

The **R1/R2** indicators turn **ON** when the respective receiver input is activated.

The **INPUT R1/R2** Connectors are used to input the measurement signal.

The **TEST ATTEN** Keys display the current test input attenuation on the keyboard input line, which can then be changed. These keys also display the **IF RANGE** selection softkey.

The **T1/T2** indicators turn **ON** when the receiver input is activated.

The **INPUT T1/T2** Connectors input the signal to be measured.

NOTE

Remembering that the putty-gray control unit front panel keys call their own softkeys when press will help you to operate the 4195A.

2-4. A TOUR OF THE REAR PANEL

The rear panel illustration is printed on the inside part of the fold-out page next to the front panel illustration in Appendix H. A brief description of the rear panel connectors, switches, etc. follows.

- (1) The **10 MHz OUTPUT** Connector supplies a 10 MHz signal to use to synchronize external equipment.
- (2) The **EXT REFERENCE** Connector is used to input an external signal to synchronize the 4195A.
- (3) The **PROGRAM START** Connector is used to externally start or continue a 4195A user program (ASP).
- (4) The **EXT TRIGGER** Connector is used to externally trigger the 4195A to make a single point measurement.
- (5) The **HP-IB** Connector interfaces the 4195A to the HP-IB bus.
- (6) The ~ **LINE VOLTAGE SELECTOR** Switches are used to set the operating voltage of the 4195A to match the local power line voltage.
- (7) The ~ **LINE FUSE** Holder contains the power line fuse.
- (8) The ~ **LINE** Power Line Receptacle is used to apply AC power to the 4195A.
- (9) The **J6** 9-pin Connectors interconnect the control and measurement units.
- (10) The **J5** 50-pin Connectors interconnect the control and measurement units.
- (11) The **8-BIT INPUT/OUTPUT** Connector is used for general purpose TTL level input/output signals.
- (12) The **J4** BNC Connectors interconnects the control and measurement units.
- (13) The **J3** BNC Connectors interconnect the control and measurement units.
- (14) The **J2** BNC Connectors interconnect the control and measurement units.
- (15) The **REFERENCE OVEN** Connector (**Option 001** units only) is the output of the crystal oven oscillator. When this output is connected to the **EXT REFERENCE** connector on the control unit's rear panel, the 4195A's frequency accuracy/stability will be improved.

2-5. CRT DISPLAY AREA DEFINITION

The 4195A CRT display is divided by the following areas as shown in Figure 2-1.

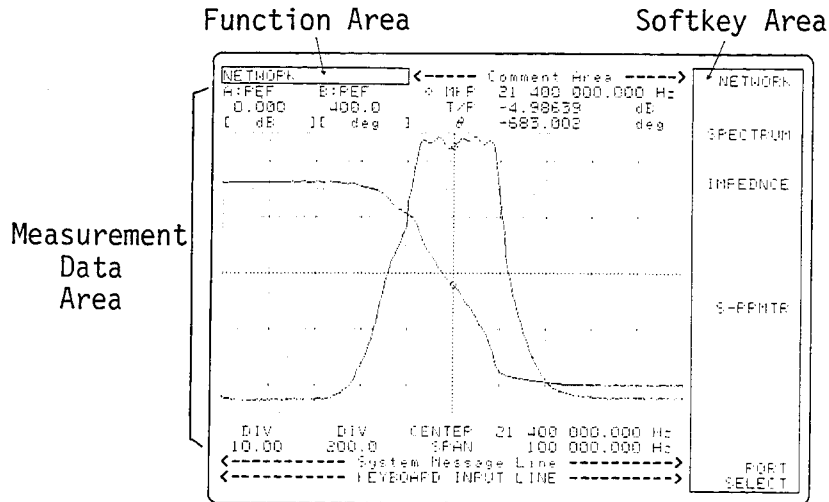

Figure 2-1. CRT Display Area Definition

Function Area:

An eighteen character long line, starting from the upper left corner, is the function area. "NETWORK", "SPECTRUM", "IMPEDNCE", "S11", "S21", "S12", or "S22" are displayed depending on the 4195A's configuration.

Comment Area:

The rest of the line at the top of the screen (except for the function area) is the comment area. The comment area is where you enter your own display comments. Entering a comment is a useful way to identify hard copies of the screen, entering the name of signal to be measured or the measurement setup as a comment is one way to identify hard copies.

System Message Line:

The second line from the bottom of the screen is the system message line. Usually the receiver settings (Resolution Bandwidth setting, etc.) will be displayed on the system message line. If you try to perform an illegal operation, an error message is displayed on the system message line. When certain keys are pressed, the 4195A will display an instruction on the system message line to help you perform the next operation.

Keyboard Input Line:

The bottom line of the screen is the keyboard input line on which the parameter values are entered and on which commands from the front panel keyboard are entered to be executed.

Softkey Area:

A six character wide area on the right side of the screen is the softkey area which is used to display the softkey labels.

Measurement Data Area:

The rest of the screen is the measurement data area, where measured data, measurement setting, analysis data, etc. are displayed. The contents of the Measurement Data Area are determined by the selected measurement function and display format.

NOTES

SECTION 3

BASIC MEASUREMENT EXAMPLES

3-1. INTRODUCTION

This section gives examples of the HP 4195A's basic measurement operation. The examples in this section are designed so you can perform them to familiarize yourself with the 4195A. These examples are a guide to help you to learn the operation of the 4195A, they may not apply directly to your application. For more practical information on making accurate measurements, and for more examples, read Section 4.

The **WARNINGS**, **CAUTIONS**, and **NOTES** given throughout this document must be carefully followed to ensure the operator's safety and the serviceability of the 4195A.

WARNING

BEFORE TURNING THE 4195A ON, ALL PROTECTIVE EARTH TERMINALS, EXTENSION CORDS, AUTOTRANSFORMERS, AND DEVICES CONNECTED TO THE 4195A MUST BE CONNECTED TO EARTH GROUND. ANY INTERRUPTION OF EARTH GROUND CONSTITUTES A SHOCK HAZARD WHICH MAY RESULT IN PERSONAL INJURY.

ONLY FUSES WITH THE REQUIRED CURRENT RATING AND OF THE SPECIFIED TYPE CAN BE USED. DO NOT USE A SUBSTITUTE FOR THE PROPER FUSE AND NEVER SHORT CIRCUIT THE FUSE-HOLDER. DOING SO CONSTITUTES A SHOCK HAZARD.

CAUTION

Before you turn your 4195A on, be sure to set the voltage selector to the line voltage to be used, or the instrument will be damaged.

3-2. NETWORK MEASUREMENT EXAMPLE

In this example you are going to observe the transmission frequency response of a Band-pass Filter. Prepare a bandpass filter with the following specifications, and then follow the given procedure.

Center Frequency	100 MHz or higher, and 400 MHz or lower
Input/Output Impedance	50Ω or 75Ω

Recommended Accessories Used In The Following Example:

For 50Ω device measurement:

50Ω N(m)-N(m) Cable	11851B (4 cables included)
Power Splitter	11667A (two-way) or 11850C (three-way)

For 75Ω device measurement:

75Ω N(m)-N(m) Cable	11857B (2 cables included)
50Ω N(m)-N(m) Cable	11851B (4 cables included)
Power Splitter	11850D (three-way)
50Ω-75Ω Minimum Loss Pad	11852B (furnished with the 11850D)

Procedure:

1. Leave all front panel **OUTPUT/INPUT** connectors open.
2. Press the **CONFIG** key.

The **CONFIG** key is located in the **MEASURE** section of the control unit (upper unit of the 4195A) front panel.

You will see the softkey labels that includes '**NETWORK**', '**SPECTRUM**', etc. The 4195A measurement configuration can be selected on this page.

3. Press the '**NETWORK**' softkey.

The '**NETWORK**' softkey is located at the first key from the top at the right hand edge of the CRT. When the '**NETWORK**' softkey is pressed, the softkey label will change to green.

NETWORK will be displayed in the Function Area (the upper left corner of the CRT). This indicates that the 4195A is in network configuration.

4. Press the **PRESET** key.

The **PRESET** key is located at the lower center of the control unit front panel. The **PRESET** key will clear most of the previous control settings and return them to the default settings. The **PRESET** key will not clear control settings that are unique to unselected configurations.

5. Connect the bandpass filter as shown in Figure 3-1.
6. Press the **CENTER** key.

CENTER= 250000000.000 HZ will be displayed on the keyboard input line.

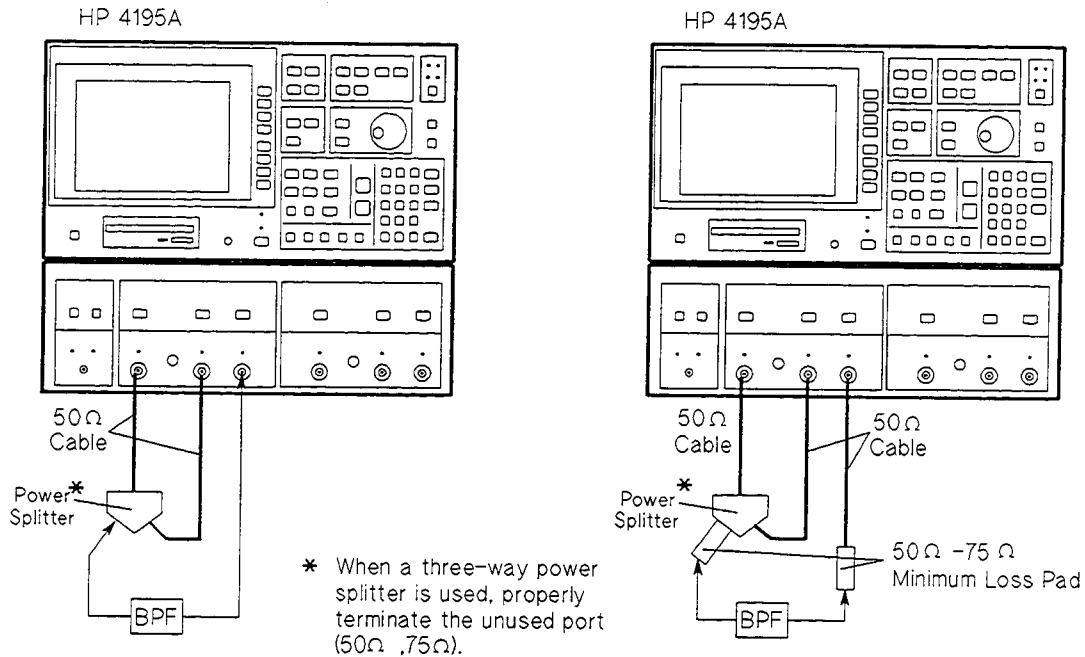

50 Ω Device Measurements

75 Ω Device Measurements

Figure 3-1. Network Measurement Example Setup

7. Enter the center frequency of your bandpass filter using the numeric and unit keys.

The center frequency can be changed using the **arrow up** and **arrow down** keys instead of numeric and unit keys.

8. Press the **SPAN** key and change the frequency span as appropriate for measuring your bandpass filter.
9. Press the **RES BW** key.

RBW= (the currently set resolution bandwidth) will be displayed on the keyboard input line.

10. Press the **arrow down** key.

Every time you press the **arrow down** key, the resolution bandwidth will be narrowed, the time required for measurement will be increased, and you will observe less fluctuation on the traces.

11. Press the **VIDEO FILTER** key.

The indicator located at the center of **VIDEO FILTER** turns **ON**. You will observe less fluctuation in the resulting measurement traces on the CRT, and the measurement time will increase.

12. Using the resolution bandwidth filter and the video filter settings, find the best measurement stability and the sweep time for your measurement.

13. Press the **MKR** → key and '**MKR→ MAX**' softkey.

The marker will move to the maximum value of the yellow trace. The frequency at which the insertion loss of the bandpass filter is minimum, the yellow trace maximum value (insertion loss) and the phase shift at the frequency are displayed above the graph area of the screen.

14. Press the **MODE** key and the '**oMKR & LCURS**' softkey.

15. Press the '**Δmode on off**' softkey so that **on** changes to **green**.

16. Press the '**more 1/2**' and '**WIDTH on off**' softkey to select **on**.

The difference between the marker and the line cursor in dBs and the frequency width between the two intersection points of the yellow trace and the line cursor will be displayed.

17. Rotate the **knob** in both directions.

The line cursor will move up and down. You can read the difference between the o marker and the line cursor to determine the bandwidth of the filter.

18. Press the '**ΔVALUE entry**' softkey.

DLCURS= will be displayed on the keyboard input line.

19. Press the minus (-), **3**, and **ENTER/EXECUTE** keys in sequence.

The line cursor will move to the point which is -3 dB from the insertion loss level, and the -3 dB bandwidth will be displayed.

20. Press the '**Q VALUE**' softkey.

The quality factor value of the filter at the -3 dB point will be displayed.

21. Press the **MODE** key and '**off**' softkey.

The marker and the line cursor will disappear.

22. Press the **FORMAT** key and '**T/R-τ (dB)**' softkey.

The blue trace shows the group delay, not the phase shift.

23. Press the **SCALE REF** key and '**SCALE forA forB**' softkey to select **forB** (change to green).

24. Press the '**B AUTO SCALE**' softkey.

The display scale for the group delay measurement result will be optimized.

NOTE

This example simply shows measurement operation, the calibration capability of the 4195A was not used. Refer to paragraph 4-8, MEASUREMENT CALIBRATION, for useful techniques when high accuracy measurements are required.

3-3. SPECTRUM MEASUREMENT EXAMPLE

In this example you are going to observe the harmonic distortion of a 10 MHz signal. The 10 MHz signal available from the control unit's rear panel is used for this example.

Recommended Accessories Used In The Following Example:

50 Ω BNC(m)-BNC(m) Cable, 122 cm	HP PN 8120-1840
N(m)-BNC(f) Adapter	HP PN 1250-1476

Procedure:

1. Leave all front panel **OUTPUT/INPUT** connectors open.
2. Press the **CONFIG** key.

The **CONFIG** key is located in the **MEASURE** section of the control unit (upper unit of the 4195A) front panel.

You will see the softkey labels that includes '**NETWORK**', '**SPECTRUM**', etc. The 4195A measurement configuration can be selected on this page.

3. Press the '**SPECTRUM**' softkey.

The '**SPECTRUM**' softkey is located at the second key from the top of the Soft-key Area (the right hand edge of the CRT). When the '**SPECTRUM**' softkey is pressed, the softkey label will change to **green**.

SPECTRUM will be displayed in the Function Area (the upper-left corner of the CRT) indicating that the 4195A is in spectrum configuration.

4. Press the **PRESET** key.

The **PRESET** key is located at the lower center of the control unit front panel. The **PRESET** key will clear most of the previous control settings and return them to the default settings. The **PRESET** key will not clear control settings that are unique to unselected configurations.

5. Press the **CHANNEL 1 RECEIVER REF ATTEN** key.

ATR1= 10 DB will be displayed on the keyboard input line, and the softkey labels are changed for IF Range selection. The '**IF RNG NORMAL**' softkey label will be change to **green**.

6. Press the **arrow up** key three times.

The R1 input attenuator will be set to 40 dB and the **RANGE** display for the R1 input (displayed on the right hand side of the system message line) will change to +20 dBm. This is for measuring a maximum amplitude signal of +20 dBm.

7. Connect the **10 MHz OUTPUT** connector on the control unit rear panel and the **R1** connector on the measurement unit front panel as shown in Figure 3-2.

You will see the 10 MHz fundamental signal and some spurious signals traces on the CRT. The 10 MHz **OUTPUT** signal is not a pure sine wave, because the purpose for which this signal is intended does not require high spectral purity.

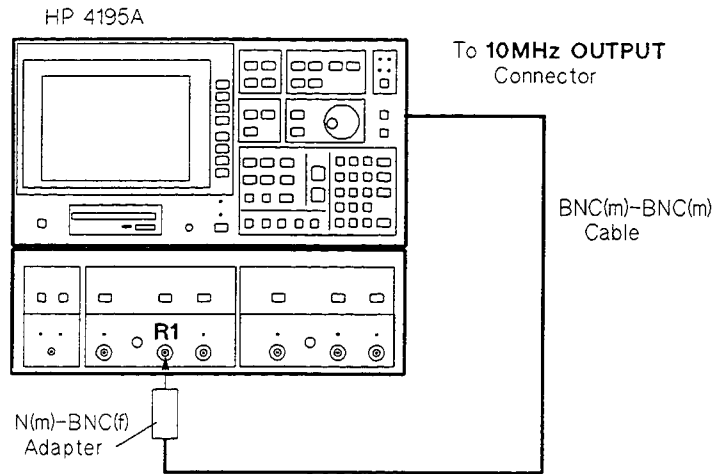

Figure 3-2. Spectrum Measurement Example Setup

8. Press the **SCALE REF** key and the '**A AUTO SCALE**' softkey.
9. Press the **START** key.

START= 0.001 HZ will be displayed on the keyboard input line. This reports that the currently set **START** frequency (the most left of the measurement trace) is 1 mHz.

10. Press the **5** and **MHz/V** keys.

When you press the **5** key, the previously displayed **0.001 HZ** will disappear. When you press **MHz/V** key, the start frequency is changed to 5 MHz and **START= 5000000.000 HZ** will be displayed. The currently set **START** and **STOP** frequencies are displayed below the displayed graph.

11. Press the **STOP**, **1**, **0**, **5**, and **MHz/V** keys in sequence.
12. Press the **MKR →** key and the '**MKR→ MAX**' softkey.

The marker will move to the 10 MHz point on the trace.

13. Press the '**NEXT PEAK**' softkey.

The marker will move to the next lower peak, each time you press '**NEXT PEAK**'.

14. Disconnect the input signal from the **R1** connector.
15. Press the '**more 1/2**', and '**NOISE on off**' softkeys to select **on**.
16. Rotate the **knob** to select a frequency at which to read the noise level.

The noise level (normalized per hertz) will be displayed above the graph area of the CRT.

3-4. IMPEDANCE MEASUREMENT EXAMPLE

This example shows how to measure the impedance characteristics of a chip type component under the following measurement conditions.

Test Frequency	100 kHz to 500 MHz (log sweep)
Output Level	0 dBm

Recommended Accessories Used In The Following Example:

Impedance Test Kit	41951A
Test Fixture	16092A

Procedure:

1. Connect the impedance test adapter from the HP 41951A to the front panel of the 4195A.

Figure 3-3 shows the impedance test adapter connected to the 4195A.

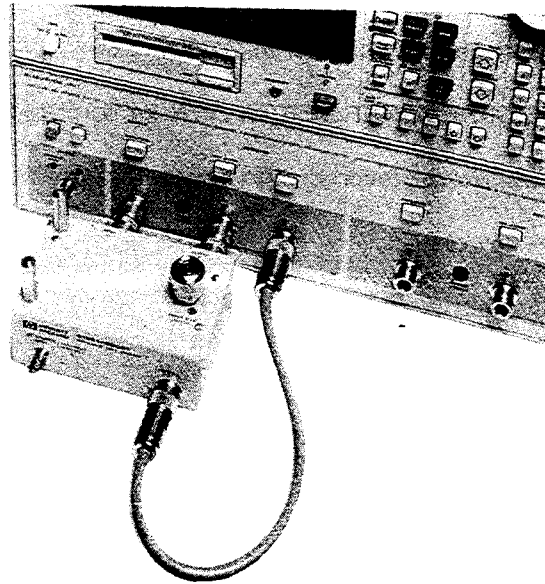

Figure 3-3. Impedance Test Adapter Connection

2. Press the **CONFIG** key and 'IMPEDNCE' softkey, then press the **PRESET** key.
3. Press the **START** key.

START= 0.001 HZ will be displayed on the keyboard input line. This reports that the currently set **START** frequency (the most left of the measurement trace) is 1 mHz.

4. Press the **1, 0, 0,** and **kHz/dBm** keys.

When you press the **1** key, the previously displayed **0.001 HZ** will disappear. When you finally press the **kHz/dBm** key, the start frequency is changed to 100 kHz and **START= 100000.000 HZ** will be displayed. The currently set **START** and **STOP** frequencies are displayed below the displayed graph.

5. Press the **MENU** key and the '**TYPE lin log**' softkey.

When you press the '**TYPE lin log**' softkey, the '**log**' of the '**TYPE lin log**' softkey label will change to intensified **green**, and log sweep is set.

NOTE

Steps 10 and 11 set the 4195A's output level to 12 dBm so that the output level at the 41951A impedance test adapter's measurement terminal will be 0 dBm (insertion loss of the 41951A is approximately 12 dB). Steps 6 to 9 set the input attenuators to 20 dB so that the input ports will not be overloaded by the 12 dBm input level.

6. Press the **CHANNEL 1 RECEIVER REF ATTEN** key on the lower unit's front panel.

ATR1= 10 DB will be displayed on the keyboard input line.

7. Press the **arrow up** key once.

The R1 input attenuator will be set to 20 dB.

8. Press the **CHANNEL 1 RECEIVER TEST ATTEN** key on the lower unit's front panel.

ATT1= 10 DB will be displayed on the keyboard input line.

9. Press the **arrow up** key once.

The T1 input attenuator will be set to 20 dB.

10. Press the **CHANNEL 1 SOURCE AMPLITUDE** key on the lower unit's front panel.

OSC1= 0.0 DBM will be displayed on the keyboard input line.

11. Press the **1, 2** and **kHz/dBm** keys.

The output level value displayed on the keyboard input line will be changed to **OSC1= 12.0 DBM**.

12. Press the **CAL** key and the '**CAL menu**' softkey.

13. Press the '**ONE PORT FULL CAL**' softkey.

14. Connect the **OPEN** termination furnished with the 41951A (labeled as OS) atop the APC-7 connector of the Impedance Test Adapter.

Rotate the coupling nut of the APC-7 connector CW (clockwise) so that the coupling sleeve protrudes fully. **Do not touch the terminal contact surface with your fingers (to maintain optimum contact cleanliness)**. Place the **OPEN** termination on the APC-7 connector. Hold the center brass part of the termination so it will not rotate, and rotate the termination cap nut CW (clockwise) until fully tightened, **DON'T OVER TIGHTEN**.

15. Press the **'OPEN'** softkey and the **ENTER/EXECUTE** key.

Measuring OPEN will be displayed, and **SHORT CAL required** will be displayed after a short time.

16. Disconnect the **OPEN** termination and connect the **SHORT** termination furnished with the 41951A (labeled as 0Ω) atop the APC-7 connector of the Impedance Test Adapter.

Place the **SHORT** termination on the APC-7 connector. **Carefully handle the termination so as not to damage or contaminate its precision contact surface.** Hold the center brass part of the termination so it will not rotate, and rotate the termination cap nut CW (clockwise) until fully tightened, **DON'T OVER TIGHTEN.**

17. Press the **'SHORT'** softkey and the **ENTER/EXECUTE** key.

Measuring SHORT will be displayed, and **LOAD CAL required** will be displayed after a short time.

18. Disconnect the **SHORT** termination and connect the **LOAD** termination furnished with the 41951A (labeled as 50Ω) atop the APC-7 connector of the Impedance Test Adapter.

Rotate the coupling nut of the 50Ω termination so that the coupling sleeve of the termination is at its innermost free position. Place the 50Ω termination on the APC-7 connector. Hold the termination body so it will not rotate, and rotate the outer nut of the termination CW (clockwise.) until fully tightened, **DON'T OVER TIGHTEN.**

19. Press the **'LOAD'** softkey and the **ENTER/EXECUTE** key.

Measuring LOAD will be displayed, and **Calculating CAL coefficient** will then be displayed after a short time.

NOTE

To confirm that calibration is being performed properly, press the **'CORRECTN on off'** softkey to set calibration function to on, and the **TRIG/RESET** key to measure the 50Ω termination. If measurement result is approximately 50Ω , calibration is being performed properly, and you can proceed to step 20 after the **CAL** key is pressed.

20. Disconnect the 50Ω termination and place the test fixture atop the Impedance Test Adapter as shown in Figure 3-4.

After use, leave the 50Ω termination coupling sleeve screw protruding to prevent possible impairment to the termination surface.

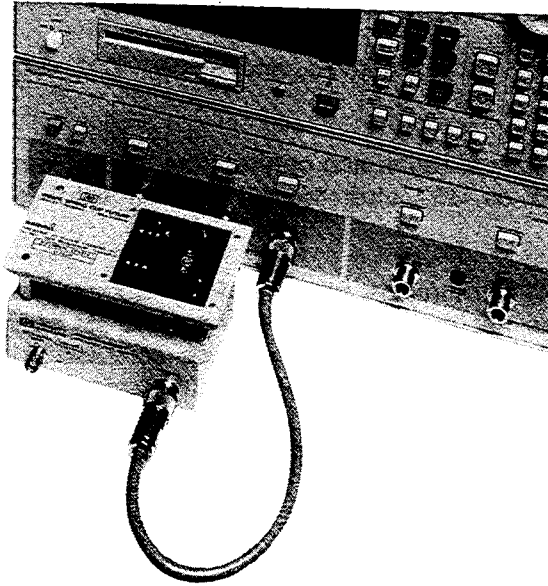

Figure 3-4. Test Fixture Connection

21. Press the '**COMPEN menu**' softkey and '**0S&0Ω OFFSET**' softkey.
22. Open the measurement terminal of the test fixture.

Set the attachment as shown in Figure 3-5 open position so that the center conductor does not short to the outer conductor.

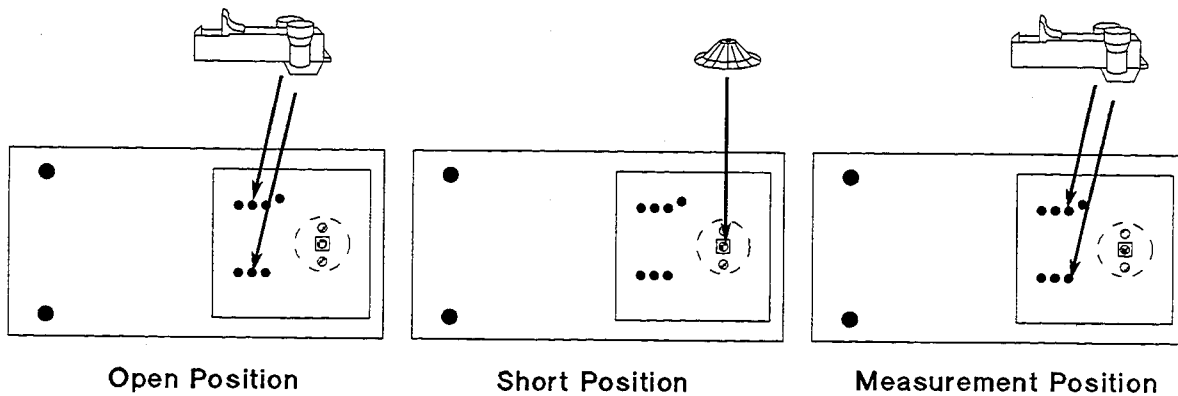

Figure 3-5. Attachment Connection

23. Press the '**0S**' softkey and the **ENTER/EXECUTE** key.

Measuring 0S will be displayed, and **0Ω compen required** will be displayed after a short time.

24. Short the measurement terminal of the test fixture.

Remove the attachment from the 16092A, and set the short ring (furnished with the 16092A) to the 16092A's center conductor as shown in Figure 3-5 short position.

25. Press the '0 Ω ' softkey and the ENTER/EXECUTE key.

Measuring 0 Ω will be displayed, and **Compen completed (TURN ON "CORR" KEY)** will be displayed after a short time.

26. Press the 'CORRECTN on off' softkey.

Calculating CAL coefficient will be displayed, and the 'on' of the 'CORRECTN on off' softkey label will be changed to green after a short time.

NOTE

Refer to paragraph 4-8, for details about Calibration.

27. Connect the component to be measured to the test fixture.

Set the attachment on the 16092A as shown in Figure 3-5 measurement position, and connect the component to the attachment.

28. Press the TRIG/RESET key to measure the device under test.

3-5. S-PARAMETER MEASUREMENT EXAMPLE

In this example you will measure the S-Parameters of a network.

Recommended Accessories Used In The Following Example:

For 50Ω device measurement:

Transmission/Reflection Test Set 41952A, 2 set

For 75Ω device measurement:

Transmission/Reflection Test Set 41952B, 2 set

Procedure:

1. Connect two Transmission/Reflection Test Sets (two HP 41952A/Bs) to the 4195A's front panel output/input connectors as shown in Figure 3-6.

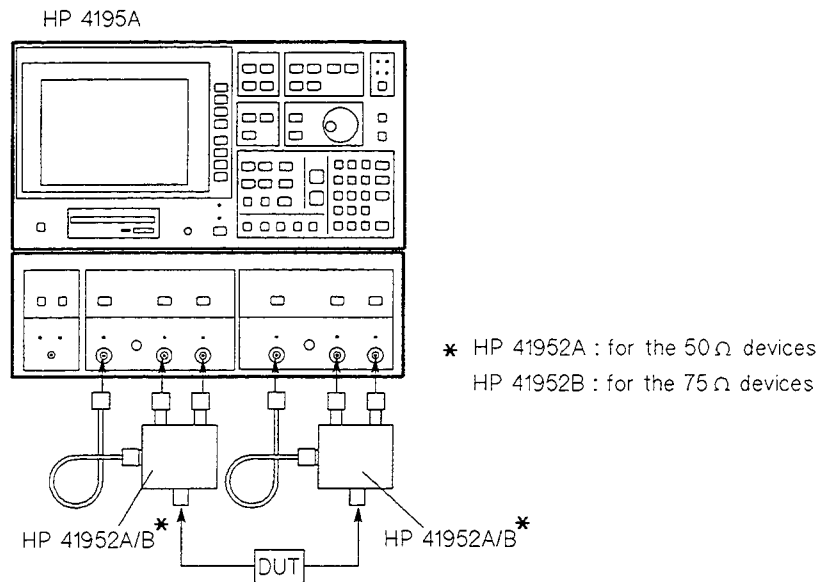

Figure 3-6. S-Parameter Configuration Setup Example

2. Connect the network under test between the TEST PORTs of the two HP 41952A/Bs.
3. Press the **CONFIG** key and '**S-PRMTR**' softkey, then press the '**S11**' softkey.
4. Press the **PRESET** key.

The yellow LED indicators at connectors **S1**, **R1**, and **T1** will turn **ON**.

5. Press the **DISPLAY** key and '**SMITH**' softkey.

The measurement **FORMAT** (parameter) is automatically changed to $\Gamma_x\text{-}\Gamma_y$. Now the 4195A displays S11 (forward reflection) on the Smith chart.

6. Press the **CONFIG** key and '**S21**' softkey, then press the **PRESET** key.

The yellow LED indicators at connectors **S1**, **R1**, and **T2** will turn **ON**. Now the 4195A displays S21 (forward transmission) frequency response characteristics.

7. Press the **FORMAT** key and the '**T/R- τ (dB)**' softkey.

Now the 4195A displays S21 (forward transmission) group-delay frequency response characteristics.

8. Press the **SCALE REF** key, and the '**SCALE forA forB**' and '**B AUTO SCALE**' softkeys.

The display scale for the group delay measurement result will be optimized.

9. Press the **CONFIG** key and the '**S12**' softkey, then press the **PRESET** key.

The yellow LED indicators at the **T1**, **S2**, and **R2** connectors will turn **ON**. Now the 4195A displays S12 (reversed transmission) frequency response characteristics.

10. Press the **CONFIG** key and the '**S22**' softkey, then press the **PRESET** key.

The yellow LED indicators at connectors **S2**, **R2**, and **T2** will turn **ON**.

11. Press the **DISPLAY** key and '**POLAR**' softkey.

The measurement **FORMAT** (parameter) is automatically changed to Γ_x - Γ_y . Now the 4195A displays S22 (reversed reflection) on the polar chart.

12. Press the **SCALE REF** key and the '**AUTO SCALE**' softkey.

13. Press the **CONFIG** key. Then press '**S11**', '**S21**', '**S12**', and '**S22**' softkeys in sequence.

As you can see, the 4195A remembers the measurement format (parameter) and the display format for each S-parameter configuration.

14. Select the measurement conditions (frequency range, resolution bandwidth, etc.).

You can measure all four S-parameters by just selecting the '**S11**', '**S21**', '**S12**', and '**S22**' softkeys.

NOTE

This example simply shows measurement operation, the calibration capability was not used. Refer to paragraph 4-8, MEASUREMENT CALIBRATION, for techniques you can use to make more accurate measurements.

NOTES

SECTION 4

MEASUREMENT CAPABILITIES

4-1. INTRODUCTION

This section provides information on the HP 4195A's measurement capabilities. The information given in this section will enable you to use the 4194A's basic measurement functions. For information on the 4195A's other enhanced capabilities refer to Section 5.

NOTE

This section includes some of the 4195A's control commands. The control commands corresponding to the 4195A's softkey labels are shown in Appendix D. All of the 4195A commands are listed in Appendixes E and F.

4-2. GENERAL MEASUREMENT INFORMATION

The 4195A can be used to measure and analyze circuits, components, or signals using three test stimulus (test parameters) -- frequency, oscillator level (test signal amplitude, or power), and DC bias voltage (DC source level). One of the three parameters is selected as the sweep parameter and the remaining two parameters are set to a fixed value. The frequency range is 10 Hz to 500 MHz. The oscillator level range is -50 dBm to +15 dBm. The dc bias voltage range is ± 40 V.

NOTE

Since the 4195A's measurement circuit settings (hardware), and the display/data read-out/analysis (software) are independent, the trace scale for the CRT screen plot is not restricted by the measurement control settings.

4-3. MEASUREMENT CONFIGURATION

The 4195A has Network, Spectrum, Impedance, and S-Parameter (S11, S21, S12, and S22) measurement configurations. The selected configuration is displayed in the function area (upper left corner) of the screen.

The Network, Impedance, and S-Parameter measurement configurations use one source output and two receiver inputs. The source output is split into two paths by an external splitter, one output of which is used the reference, and the other is used as the test signal. The receiver detects two input signals -- REFERENCE and TEST -- and the amplitude ratio and the phase difference of the two signals are converted into the selected measurement format.

The Spectrum configuration uses only one of the four receiver inputs. The swept tuned receiver (sensitive to only the current measurement frequency component) detects the input signal level (absolute amplitude).

The measurement configuration is selected by pressing one of the softkeys displayed when the **CONFIG** key is pressed.

Paragraphs 4-4 through 4-7 explains, in detail, each of the four measurement configurations.

4-4. NETWORK CONFIGURATION

The network configuration is selected by pressing the **'NETWORK'** softkey or sending the **FNC1** command.

In the Network configuration the amplitude ratio and phase difference between two the input signals are measured. When used with a power splitter, the network configuration is used for measuring transmission gain/loss and phase shift. When used with a directional bridge, the network configuration is used for measuring the reflection characteristics of the circuit under test.

4-4-1. NETWORK CONFIGURATION PORT SELECTION

Pressing the **CONFIG** key and the **'PORT SELECT'** softkey displays the set of port selection softkeys used to define the output/input connectors used for network measurements. There are five possible port selection combinations which are listed in Table 4-1. For example, when **'T1/R1'** is selected, the **T1** and **R1** connectors are used for test and reference inputs, respectively, and the **S1** connector is used to output the test signal. The default setting is **'T1/R1'**.

Table 4-1. Network Configuration Port Selection

Softkey	Test	Reference	Source	Command
'T1/R1'	T1	R1	S1	PORT1
'T2/R1'	T2	R1	S1	PORT2
'R2/R1'	R2	R1	S1	PORT3
'T1/R2'	T1	R2	S2	PORT4
'T2/R2'	T2	R2	S2	PORT5

4-4-2. NETWORK CONFIGURATION MEASUREMENT PARAMETERS

Pressing the **FORMAT** key when in the network configuration displays the set of measurement format (parameter) selection softkeys used to define the trace A and B data. There are four possible measurement formats (parameters) available in the network configuration. The default setting is **'T/R(dB)- θ '** (or **'R2/R1(dB)- θ '**).

1. **'T/R(dB)- θ '** or **'R2/R1(dB)- θ '** (Command is GPP1)

The amplitude ratio between the selected test input and the selected reference input is measured and displayed in dB units as trace A. When the 4195A is used for transmission measurement, trace A represents the gain or attenuation of the network under test. When the 4195A is used for the reflection measurement, trace A represents the return loss of the network under test.

The phase difference between the selected test input and the selected reference input is measured and displayed as trace B. The measurement unit is degrees (**deg**) or radians (**rad**), which is determined by the angle mode setting. Refer to paragraph 5-5, ANGLE MODE. The default unit is degrees.

2. 'T/R- θ ' or 'R2/R1- θ ' (Command is GPP2)

The voltage ratio between the selected test input and the selected reference input is measured and displayed as trace A. When the 4195A is used for the reflection measurement, trace A represents the absolute value of the reflection coefficient ($|\Gamma|$) of the network under test.

The phase difference is the same as in the 'T/R(dB)- θ ' format and is displayed as trace B.

3. 'T/R Re-Im' or 'R2/R1 Re-Im' (Command is GPP3)

The vector voltage ratio between the selected test input and the selected reference input is measured and displayed. The real and imaginary components of the ratio are displayed as trace A and B, respectively. When the 4195A is used for reflection measurement, trace A and B data are the real and imaginary components of the reflection coefficient (Γ_x and Γ_y) of the network under test, respectively.

4. 'T/R(dB)- τ ' or 'R2/R1(dB)- τ ' (Command is GPP4)

The amplitude ratio as same as 'T/R(dB)- θ ' format is measured and displayed as trace A.

Group delay is measured and displayed as trace B. Refer to paragraph 4-4-3. GROUP DELAY MEASUREMENT.

4-4-3. GROUP DELAY MEASUREMENT

When the 'T/R(dB)- τ ' or 'R2/R1(dB)- τ ' measurement format is selected, the 4195A internally performs a 'T/R(dB)- θ ' (or 'R2/R1(dB)- θ ') measurement and calculates the group delay (τ in seconds) using the following formulas.

$$\begin{array}{ll} \tau = \Delta\theta / (360 \times \Delta f) & \text{in the degree mode, or} \\ \tau = \Delta\theta / (2 \times \pi \times \Delta f) & \text{in the radian mode} \end{array}$$

Where Δf is the delay aperture in Hz,
 $\Delta\theta$ is the phase difference of the two frequency points, the frequency points are specified by Δf .

For the 4195A the group delay at point n , $\tau(n)$ is represented by the following equation. (Only the degree mode equation is shown.)

$$\tau(n) = \frac{ \{ \theta(n - \Delta n) - \theta(n + \Delta n) \} }{ 360 \times \Delta f } \quad (\text{seconds})$$

Where n is the current measurement point for which the group delay is to be measured.

Δn is the number of measured points from the center point and is calculated using the following equation.

$$\Delta n = (\text{NOP} - 1) \times (\Delta f / \text{SPAN}) / 2$$

NOP is the total number of measurement points in the sweep span, and can be selected from 2 to 401.

SPAN is the frequency span of the sweep measurement.

Δf is the delay aperture in Hz.

$\theta(n - \Delta n)$ is the measured phase at the lowest point in the aperture.

$\theta(n + \Delta n)$ is the measured phase at the highest point in the aperture.

Figure 4-1 shows an example relationship of the above factors, when Δn is 2.

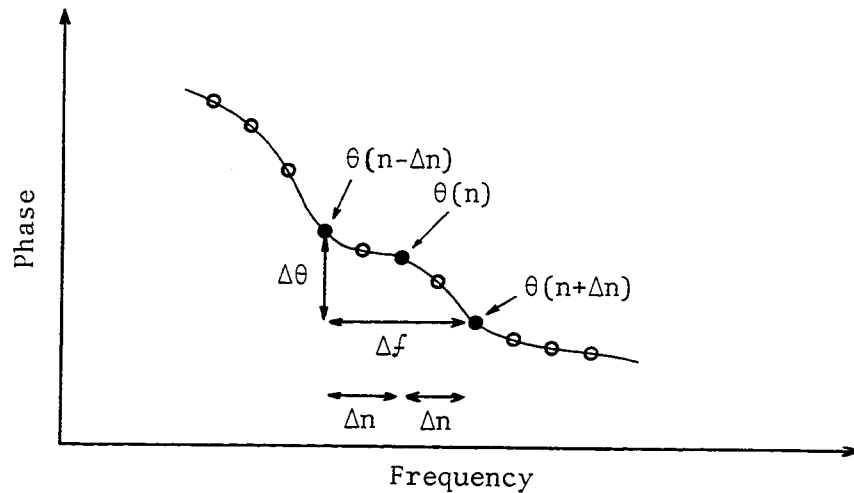

Figure 4-1. Relationship of Factors

NOTE

When $(n - \Delta n)$ is less than or equal to 1, $\theta(n - \Delta n)$ is $\theta(1)$ (measured phase data at the start frequency point). When $(n + \Delta n)$ is greater than or equal to NOP, $\theta(n + \Delta n)$ is $\theta(\text{NOP})$ (measured phase data at the stop frequency point).

The delay aperture is selected using 'APERTURE entry' softkey (or the **DFREQ=** command). The aperture is in percent-of-span which can be set from 0.5% to 100% in 0.5% steps. The default value is 0.5%.

NOTE

The minimum aperture is limited by the NOP (number of measurement points), and is $200 \approx \text{NOP}$ (in percent).

A large aperture has more of a smoothing effect on the trace than a smaller aperture, but small changes in group delay may not be observable.

To review and change the aperture in percent-of-span, use the following procedure.

1. Press the **FORMAT** key and 'APERTURE entry' softkey.
2. **DFREQ=** (current aperture) will be displayed on the keyboard input line.
3. If you press one of the number keys, the currently set aperture value will be erased and the number you pressed will be displayed. If you press the left or right arrow key, the cursor will move and you can change aperture value digit by digit.
4. Press the **ENTER/EXECUTE** key.

4-4-4. NETWORK MEASUREMENT CALIBRATION

This paragraph describes the network measurement calibration procedures. For details about 4195A calibration, refer to paragraph 4-8. MEASUREMENT CALIBRATION.

1. Transmission Calibration Procedure

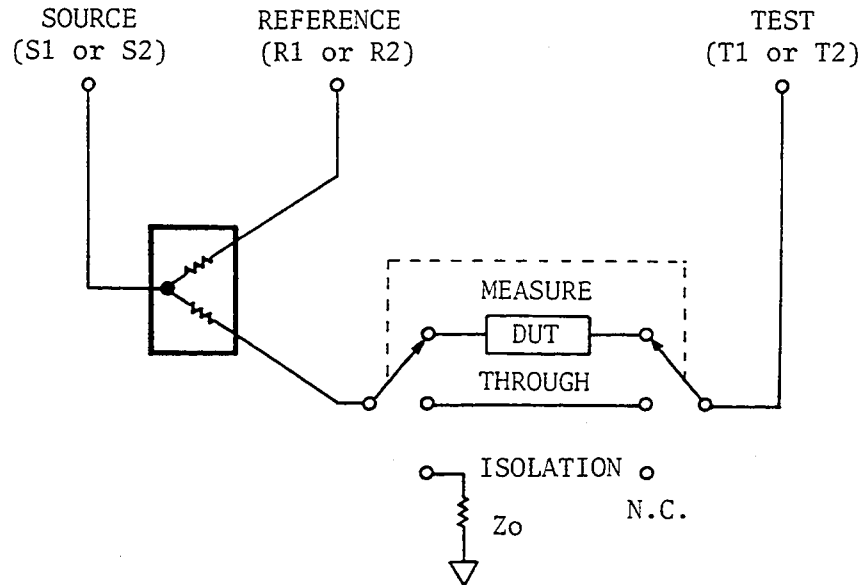

Figure 4-2. Transmission Calibration Diagram

1. Press the **CONFIG** key, the '**NETWORK**' softkey, and the **PRESET** key, in sequence.
2. Connect a power splitter, and a network as appropriate -- the MEASURE position shown in Figure 4-2.
3. Set the 4195A's stimulus and receiver settings as appropriate for the selected measurement.
4. Press the **CAL** key and the '**TRANS CAL menu**' softkey.
5. Press the '**NORM&ISN CAL**' softkey.

NOTE

If you don't need to perform the isolation calibration, press the '**NORMALIZE (THRU)**' softkey instead and skip to step 8.

6. Terminate the source signal with an impedance matched load, and disconnect the network under test from the setup, leave the test channel open -- the ISOLATION position shown in Figure 4-2.
7. Press the '**ISOLATN**' softkey and the **ENTER/EXECUTE** key, and wait until **THRU CAL required** is displayed.

8. Short circuit the test cables to make a through connection -- the THROUGH position shown in Figure 4-2.
9. Press the 'THRU' softkey and the **ENTER/EXECUTE** key, and wait until **Cal completed (TURN ON "CORR" KEY)** is displayed.
10. Connect the network under test as appropriate for the selected measurement -- the MEASURE position shown in Figure 4-2.
11. Press the '**CORRECTN on/off**' softkeys. 'on' in the '**CORRECTN on/off**' softkey will change to intensified **green** and **Cor** will be displayed in the function area of the screen. Succeeding measurements are corrected using this calibration measurement data.

2. Reflection Calibration Procedure

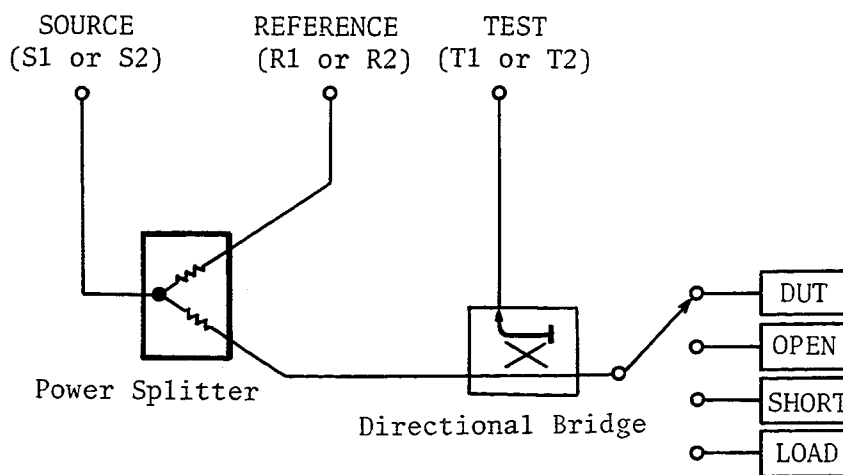

Figure 4-3. Reflection Calibration Diagram

1. Press the **CONFIG** key, the '**NETWORK**' softkey, and the **PRESET** key in sequence.
2. Connect a directional bridge, a power splitter and the network under test as appropriate for the selected measurement -- the DUT position shown in Figure 4-3.
3. Set the 4195A's stimulus and receiver settings as appropriate for the measurement.
4. Press the **CAL** key and '**more 1/2**' softkey.
5. Select the characteristic impedance of your measurement system -- 50Ω or 75Ω -- using the '**Z0 50 Ω 75 Ω** ' softkey. Each time the '**Z0 50 Ω 75 Ω** ' softkey is pressed, the selected impedance will be toggled to intensified **green**.
6. Press the '**CAL STD modify**' softkey. Previously set (or default setting) calibration values for the reference calibration standards will be displayed.
7. Press the '**OPEN CAL STD**' softkey. **OPNSTD** will be displayed on the keyboard input line.
8. Enter a good estimation of the OPEN standard's calibrated conductance in Siemens (S) and parallel capacitance in Farads (F) units separated by a comma (,). For example, you would press the following keys if the calibrated value is 0S + 310fF.

OPNSTD= [0] [,] [3] [1] [0] [EEX] [-] [1] [5] [ENTER/EXECUTE]

NOTE

If you need to perform only the calibration using OPEN, skip to step 13.

9. Press the '**LOAD CAL STD**' softkey. **LDSTD** will be displayed on the keyboard input line.
10. Enter a good estimation of the LOAD standard's calibrated series resistance in ohms (Ω) and the series inductance in Henries (H) separated by a comma (,). For example, you would press the following keys, if the calibrated value is 50 Ω + 5 nH.

LDSTD= [5] [0] [,] [5] [Blue Shift] [N] [ENTER/EXECUTE]

NOTE

If you need to perform only the OPEN and LOAD calibration, skip to step 13.

11. Press the '**SHORT CAL STD**' softkey. **SHTSTD** will be displayed on the keyboard input line.
12. Enter a good estimation of the SHORT standard's calibrated series resistance in ohms (Ω) and the series inductance in Henries (H) separated by a comma (,). For example, you would press the following keys, if the calibrated value is 0 Ω + 5 nH.

SHTSTD= [0] [,] [5] [Blue Shift] [N] [ENTER/EXECUTE]

13. Press the '**return**' and the '**REFLECTN CAL menu**' softkey.
14. Press the '**ONE PORT FULL CAL**' softkey.

NOTE

If you don't need to perform the SHORT calibration, press the '**ONE PORT PART CAL**' softkey instead and skip to step 17. If you don't need to perform the SHORT and LOAD calibration, press the '**NORMLIZE (OPEN)**' softkey instead and skip to step 19.

15. Disconnect the network under test, and connect the SHORT reference termination -- the SHORT position shown in Figure 4-3.
16. Press the '**SHORT**' softkey and the **ENTER/EXECUTE** key, and wait until **OPEN CAL required** is displayed.
17. Disconnect the SHORT reference termination, and connect the LOAD reference termination -- the LOAD position shown in Figure 4-3.
18. Press the '**LOAD**' softkey and the **ENTER/EXECUTE** key, and wait until **OPEN CAL required** is displayed.
19. Disconnect the LOAD reference termination, and connect the OPEN reference termination -- the OPEN position shown in Figure 4-3.
20. Press the '**OPEN**' softkey and the **ENTER/EXECUTE** key, and wait until **Cal completed (TURN ON "CORR" KEY)** is displayed.
21. Connect the network under test -- the DUT position shown in Figure 4-3.
22. Press the '**CORRECTN on/off**' softkeys. '**on**' in the '**CORRECTN on/off**' softkey will be change to intensified green and **Cor** will be displayed in the function area of the screen. Succeeding measurements are corrected using this calibration measurement data.

4-5. SPECTRUM CONFIGURATION

The 4195A is configured as a spectrum analyzer when the 'SPECTRUM' softkey is pressed or when the **FNC2** command is sent.

When the 4195A is configured for spectrum analysis measurement, the swept tuned receiver measures the input signal level (absolute amplitude) at the current measurement frequency. The sensitive frequency bandwidth around the current measurement frequency can be selected by setting the resolution band width (RBW).

4-5-1. MEASUREMENT UNITS FOR THE SPECTRUM CONFIGURATION

Six measurement units are available in the Spectrum Configuration. The 4195A's spectrum measurement formats can be categorized as -- Amplitude Measurement Units and Noise Measurement Units.

To select the spectrum measurement unit, press the **FORMAT** key, and select and press a softkey. Table 4-2 lists the measurement unit selection softkeys and the corresponding commands.

Table 4-2. Spectrum Measurement Units

Unit	Softkey	Command
dBm	dBm	SAP1
dB μ V	dB μ V	SAP2
Vrms	V	SAP3
dBm/Hz	dBm/Hz	SAP4
dB μ V/ \sqrt Hz	dB μ V/Hz	SAP5
μ V/ \sqrt Hz	μ V/ \sqrt Hz	SAP6

NOTE

On the 4195A's display, dB μ V/ \sqrt Hz is displayed as dB μ V/Hz, because of the limitation of the characters which can be displayed.

1) Amplitude Measurement Units

The units dBm, dB μ V, and V (volts) are used for absolute amplitude measurement of the total input signal level within the selected resolution bandwidth.

dBm	The measurement result is displayed in units of dBm. 0 dBm amplitude is defined as 1 mW of power into a 50 Ω load. So, 0 dBm is equivalent to 223.6 mV across 50 Ω , and ten times this voltage is equivalent to an increase of +20 dB.
dB μ V	The measurement result is displayed in units of dB μ V. 0dB μ V is defined as 1 μ V voltage into a 50 Ω load. So, 0dB μ V is equivalent to -107 dBm (20 fW), and ten times this voltage is equivalent to an increase of +20 dB.
V	The measurement result is displayed in units of V (volts). So, 1 V is equivalent to +13 dBm or +120 dB μ V.

2) Noise Measurement Units

dBm/Hz, dB μ V/ \sqrt Hz, and μ V/ \sqrt Hz are the units used when measuring the absolute amplitude of the input signal level and normalizing to one hertz for measuring the noise level of an input signal.

dBm/Hz	The measurement result is displayed in units of dBm/Hz. The measurement results in dBm is normalized to 1 Hz by the resolution band width setting.
dB μ V/ \sqrt Hz	The measurement result is displayed in units of dB μ V/ \sqrt Hz. The measurement results in dB μ V is normalized per 1 Hz by resolution band width setting.
μ V/ \sqrt Hz	The measurement result is displayed in units of μ V/ \sqrt Hz. The measurement results in μ V is normalized per 1 Hz by resolution band width setting.

NOTE

When a noise measurement unit is selected, the 4195A measures only at the measurement point. If the resolution bandwidth is set narrower and the frequency interval between adjacent measurement points is wider, the sensitive frequency range (determined by the resolution bandwidth) will not overlap. This will cause a blind zone (undetected frequency component).

When the 4195A is in the frequency sweep mode and an amplitude measurement unit is selected, the 4195A is sensitive to all frequency components within the sweep range (from START to STOP). To eliminate blind frequency zones, the 4195A internally performs a multi-point measurement between two measurement points and displays the maximum result of the multi-point measurement as the measurement result of the lower frequency measurement point.

4-5-2. INPUT CONNECTORS

In the Spectrum analysis configuration, one of the four input connectors can be used at a time. This enables you to measure a maximum of four spectrum signals by electronically switching the inputs, you don't have to physically disconnect/connect cables and probes.

To select an input connector, press the **CONFIG** key, '**PORT SELECT**' softkey and a softkey for the desired input connector. Table 4-3 lists input connector selection commands.

Table 4-3. Input Connector Selection

Connector	Softkey	Command
R1	R1	PORT1
T1	T1	PORT2
R2	R2	PORT3
T2	T2	PORT4

4-5-3. BUILT-IN TRACKING GENERATOR

For expanded applications, 4195A has a built-in tracking generator whose output frequency precisely tracks the measurement sweep frequency. The tracking generator output can be selected from either of outputs S1 or S2, but not both at the same time.

To select the tracking generator output, press the **CONFIG** key, '**PORT SELECT**' softkey and select and press a softkey for to select the output source. Table 4-4 lists output selection commands.

Table 4-4. Output Connector Selection

Connector	Softkey	Command
none	SOURCE off	PWR0
S1	SOURCE CH1	PWR1
S2	SOURCE CH2	PWR2

To set the output amplitude, press the **AMPLITUDE** key above the selected output connector, then use the **ENTRY** keys or the **arrow** keys to enter the amplitude value.

4-6. IMPEDANCE CONFIGURATION

The 4195A is configured for impedance measurement when 'IMPEDNCE' softkey is pressed or when the **FNC3** command is sent.

The Impedance configuration sets up the 4195A to measure impedance parameters (Z, Y, R, X, G, B, L, C, etc.) from the amplitude ratio and phase difference relationships between two input signals. Any linear network that transforms impedance into two vector signals (e.g. a directional bridge or an impedance probe) can be used for impedance measurement. The **HP 41951A Impedance Test Kit** is recommended for impedance measurement.

4-6-1. IMPEDANCE MEASUREMENT PARAMETERS

There are twelve possible measurement format (parameters) combinations, and they are listed in Table 4-5.

Table 4-5. Impedance Measurement Parameter Combinations

Softkey	Command
Z - θ	IMP1
R - X	IMP2
Ls - Rs	IMP3
Ls - Q	IMP4
Cs - Rs	IMP5
Cs - D	IMP6
Y - θ	IMP7
G - B	IMP8
Lp - Rp	IMP9
Lp - Q	IMP10
Cp - Rp	IMP11
Cp - D	IMP12

Where |Z| and |Y| are absolute impedance and absolute admittance, respectively.

θ is the phase angle of impedance or admittance. The phase angle polarity (sign) for impedance and admittance are opposite of each other, but the absolute value of phase is the same.

R and **X** are real and imaginary components of impedance (resistance and reactance), respectively. **R** and **X** are modeled as connected in series.

G and **B** are real and imaginary components of admittance (conductance and susceptance), respectively. **G** and **B** are modeled as connected in parallel.

Ls and **Cs** are inductance and capacitance converted from impedance (series equivalent circuit model) parameters, respectively.

Lp and **Cp** are inductance and capacitance converted from admittance (parallel equivalent circuit model) parameters, respectively.

Rs is the same as **R** (resistance). **Rp** is resistance existing in parallel, so **Rp** is equal to the reciprocal of **G**.

Q and **D** are the quality factor and the dissipation factor, and they are the reciprocal of each other.

NOTE

When the User Defined Math function is used, any combination of impedance parameters can be effectively measured. For example, **|Z| - Ls** can be measured by using the following procedure.

Select the **R - X** measurement format, define a User Defined Math function as follows, and turn on User Defined Math A and B. Then **|Z|** and **Ls** will be displayed as traces A and B, respectively. Refer to paragraph 5-9, USER MATH, for details.

```
DMA = SQR ( MA * MA + MB * MB )
DMB = MB / ( 2 * PI * X )
PRMA " |Z|"
UNITA " Ω"
PRMB " LS"
UNITB " H"
```

4-6-2. PORT SELECTION

The Impedance Configuration inputs and outputs can be selected, using the same selection procedure and commands that are used for the Network Configuration. Refer to paragraph 4-4-1.

NOTE

The port selections for impedance and network are independent, so if **CHANNEL 1** is selected for network measurement and **CHANNEL 2** is selected for impedance measurement, the 4195A can measure both network and impedance by selecting the Configuration, the test setup does not need to be disconnected/connected.

4-6-3. TEST SIGNAL LEVEL

The actual test signal level (voltage/current) applied to the device under test is determined by the 4195A's output level, the insertion loss and the output impedance of the test adapter, and the impedance of the device to be measured.

4-6-4. CALIBRATION AND COMPENSATION OF THE IMPEDANCE CONFIGURATION

One Port Full Calibration, $0S/0\Omega$ Offset Compensation, and Port Extension are available in the Impedance Configuration. Refer to paragraph 4-8 for calibration details.

The One Port Full Calibration procedure is the same as the Network Configuration Reflection Calibration. Refer to paragraph 4-4-4.

NOTE

- 1) When the device to be tested is connected to the calibration plane where one port full calibration will be performed, it is not necessary to perform both port extension and $0S/0\Omega$ offset compensation. (When a coaxial cable is connected to the Impedance Test Adapter, and the device under test is connected to the coaxial cable, the calibration should be performed at the device connecting point of the coaxial cable.)
- 2) When the calibration standards cannot be connected to the device connecting point, the calibration should be performed at the closest point to where the standards can be connected to. After the calibration, the $0S/0\Omega$ offset compensation should be performed to compensate for residuals existing between the calibration plane and the device connection point.
- 3) In the case of 2) if a 50Ω coaxial cable is used for connecting between the calibration plane and the device under test, the port extension can be used to compensate from the calibration plane to the device connection point.

4-7. S-PARAMETER CONFIGURATION

The 4195A is configured for S-Parameter measurement by pressing the 'S11', 'S21', 'S12', or 'S22' softkeys or when a FNC4, FNC5, FNC6, and FNC7 command is sent. When the S-Parameter configuration is selected, the 'S-PRMTR' softkey label will change to intensified green.

The S-Parameter configuration is used to measure all network parameters -- both transmission and reflection (S11, S21, S12, and S22). Two signal dividers (or directional bridges) are required for making S-Parameter measurements. Figure 4-4 shows a typical S-Parameter measurement setup.

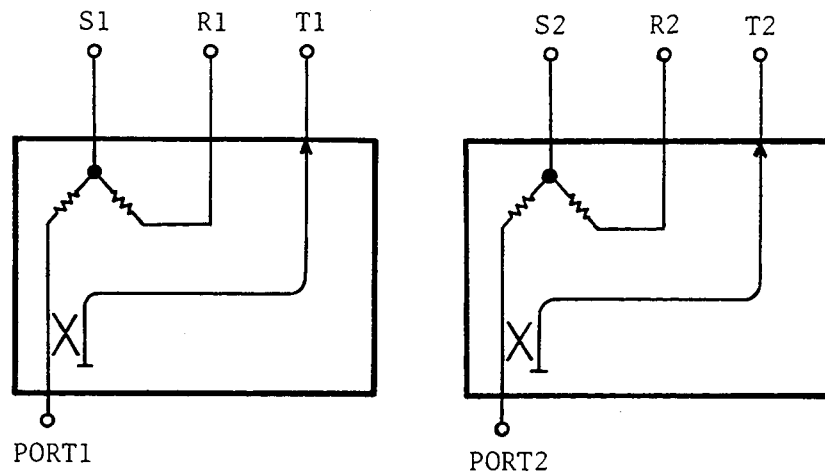

Figure 4-4. Typical S-Parameter Setup

Most of the S-Parameter configuration details are the same as those for the Network Configuration. The S-Parameter configuration features are:

1. Measurement format (measurement parameter and display format) can be selected independent of other S-Parameter measurements.
2. Calibration data is independent of other S-Parameter measurements.

Refer to paragraph 4-4. NETWORK CONFIGURATION, for details.

4-8. MEASUREMENT CALIBRATION

The 4195A Network, S-Parameter, and Impedance measurement configurations have measurement calibration capabilities which can be selected and used by using the softkeys displayed when the **CAL** key is pressed. Measurement calibration is an accuracy enhancement procedure that transfers the measured accuracy and uncertainty of standard devices to the measurement accuracy and uncertainty of a test device. Since the characteristics of standards are known to a high degree of accuracy, the system (HP 4195A plus external devices needed to measure a test device) can measure one or more standards, then use the results of these measurements to greatly enhance the measurement accuracy. The 4195A has the following measurement calibration capabilities.

for REFLECTION MEASUREMENTS (Network, S11, and S22 configurations)

1. Normalize (open) calibration
2. One port partial calibration
3. One port full calibration

for TRANSMISSION MEASUREMENTS (Network, S12, and S21 configurations)

1. Normalize (through) calibration
2. Normalize and Isolation calibration

for IMPEDANCE MEASUREMENTS (Impedance configuration)

1. One port full calibration
2. Offset compensations
 - 2-1. 0S offset compensation
 - 2-2. 0 Ω offset compensation
 - 2-3. 0S and 0 Ω offset compensation

for all measurements except for spectrum measurements

1. Port extension

NOTE

The port extension capability can theoretically offset the phase shifts that occur when a port is extended. Port extension is not measurement calibration, but it is included in the measurement calibration group because its purpose is similar to measurement calibration.

All calibration and offset compensation requires a target value (or accurately measured standards' values) to be corrected. When measurement calibration is turned on (**on** in the '**CORRECTN on off**' softkey label is intensified green), the measurement results of the standards will be equal to the target values.

NOTE

The description starting with the next paragraph assumes that the 4195A is in frequency sweep mode. For more information about the dc source level sweep and the oscillator amplitude sweep, refer to paragraph 4-8-6. CALIBRATION HINTS.

4-8-1. TRANSMISSION CALIBRATION

Transmission calibration can eliminate two error causes -- Frequency Response Error and Crosstalk Error. Transmission Calibration applies to 4195A measurements in Network (when 'TRANS CAL menu' softkey label is intensified green), S21 and S12 configurations.

Normalize (also called Through calibration or Response calibration) eliminates frequency response error. To perform **Normalize** calibration, a through connection (no-loss/no-phase-shift network) is required. To make a through connection, connect the cables together that will be connected to input and output of the network under test.

Isolation calibration is used to eliminate crosstalk error. An isolation setup is required to perform an isolation calibration. To make an isolation setup, terminate the end of the source cable (that will be connected to input of the network under test) with an impedance matched load, and leave the receiver test input cable open

NOTE

When performing an Isolation calibration the noise level must at a low enough level (compared to the crosstalk level) that the noise will not add significantly to the corrected measurement result.

The 4195A has two types of transmission calibration, and Table 4-6 lists the purpose and use of each type. Normalize is the simplest error correction to perform, but also is the least accurate. Normalize and Isolation may be adequate for well matched *high-loss* devices.

Table 4-6. Purpose and Use of Transmission Calibration Types

Calibration Type	Corresponding Measurement	Errors Removed	Standard Devices
Normalize	Well matched low insertion loss devices	Frequency response	Through
Normalize & Isolation	High insertion loss devices OR using of high leakage test fixture	Frequency response and Crosstalk	Through and Load

The calibration type is selected as follows.

1. Press the **CAL** key, and press the '**TRANS CAL menu**' softkey when in the NETWORK configuration or press the '**S-PRMTR CAL menu**' softkey when in the S21 or S12 configuration.
2. Press the '**NORMLIZE (THRU)**' softkey (or send the **CALT4** command) to select Normalize calibration. Press the '**NORM&ISN CAL**' softkey (or send the **CALT5** command) to select Normalize & Isolation calibration.

4-8-2. REFLECTION CALIBRATION

Reflection calibration can be used to eliminate three error factors -- Frequency Response, Directivity, and Source Match. Reflection Calibration applies to Network (when the '**REFLECTN CAL menu**' softkey label is intensified **green**) S11, S22, and Impedance measurements

Frequency response error can be eliminated by using **Normalize** calibration. In order to perform the Normalize calibration, an open termination must be connected to the test port.

Directivity error and frequency response error can be eliminated by using **One Port Partial** calibration. To perform this calibration, an open termination and a load termination must be sequentially connected to the test port.

Source matching error, directivity error, and frequency response error can be eliminated using **One Port Full** calibration. To perform this calibration, an open termination, a load termination, and a short termination must be sequentially connected to the test port.

NOTE

Only the **One Port Full** calibration is available in the Impedance configuration.

The 4195A has three types of reflection calibration which are listed and described in Table 4-7. Normalize is the simplest error correction to perform, but also is the least accurate. One port partial calibration may be adequate of high-return-loss devices. One port full calibration is adequate for any one-port device or a well terminated two-port device.

Table 4-7. Purpose and Use of Reflection Calibration Types

Calibration Type	Corresponding Measurement	Errors Removed	Standard Devices
Normalize	Measurement when the highest accuracy is not required.	Frequency response	Open
One Port Partial	High return loss devices	Frequency response and Directivity	Open and Load
One Port Full	Any of one-port device or well terminated two-port device	Frequency response, Directivity, and Source match	Open, Load and Short

The calibration type is selected as follows.

Network, S11, or S22 Configuration

1. Press the **CAL** key, and the '**REFLECTN CAL menu**' softkey when in NETWORK configuration or press the '**S-PRMTR CAL menu**' softkey when in the S11 or S22 configuration.
2. Press the '**NORMLIZE (OPEN)**' softkey (or send the **CALT1** command) to select the Normalize calibration. Press the '**ONE PORT PART CAL**' softkey (or send the **CALT2** command) to select the One port partial calibration. Press the '**ONE PORT FULL CAL**' softkey (or send the **CALT3** command) to select the One port full calibration.

Impedance Configuration

1. Press the **CAL** key, and the '**CAL menu**' softkey.
2. Press the '**ONE PORT FULL CAL**' softkey (or the send the **CALT1** command) to select Normalize calibration.

4-8-3. CALIBRATION STANDARD VALUES

All calibration and offset compensation requires a target value (or the accurately measured standards' value) to be corrected. Transmission calibration and offset compensation assumes the target value as zero or infinity. Standard values for reflection calibration are stored in the 4195A's memory, and these values can be modified to match your standards.

Four sets of calibration standard values are stored in the 4195A. Each set consist of **Open** termination's conductance and parallel capacitance, **Short** termination's resistance and series inductance, and **Load** termination's resistance and series inductance. One of the four groups is selected by selecting a measurement configuration (Network/S-Parameter or impedance) and the characteristic impedance (50Ω or 75Ω) using the following procedure.

1. Press the **CONFIG** key and select a configuration by using the displayed softkeys.
2. Press the **CAL** key and the 'more 1/2' softkey.
3. Select the characteristic impedance of your measurement setup using the '**Z0 50 Ω 75 Ω** ' softkey. The impedance selected will be displayed on the screen as intensified **green**.
4. Press the '**CAL STD modify**' softkey. The **CALIBRATION STANDARD DEFINITION** screen will be displayed.
5. Press the '**OPEN CAL STD**' softkey. **OPNSTD=** will be displayed on the keyboard input line.
6. Enter the Open termination's conductance (in S) and parallel capacitance (in F) separated by a comma (,), and press the **ENTER/EXECUTE** key.
7. Press the '**SHORT CAL STD**' softkey. **SHTSTD=** will be displayed on the keyboard input line.
8. Enter the Short termination's resistance (in Ω) and series inductance (in H) separated by a comma (,), and press the **ENTER/EXECUTE** key.
9. Press the '**LOAD CAL STD**' softkey. **LDSTD=** will be displayed on the keyboard input line.
10. Enter your Load termination's resistance (in Ω) and series inductance (in H) separated by a comma (,), and press the **ENTER/EXECUTE** key.

4-8-4. 0S/0Ω OFFSET COMPENSATION

0S and 0Ω offset compensation are available only in the impedance configuration. 0S and 0Ω offset compensation can compensate for the stray admittance and residual impedance of a test fixture attached at the calibration plane. Figure 4-5 shows an example of a stray admittance and residual impedance circuit model. The HP 4195A has three type of 0S/0Ω offset compensation as follows.

0S offset compensation:	Compensates for the stray admittance.
0Ω offset compensation:	Compensates for the residual impedance.
0S/0Ω offset compensation:	Compensates for the stray admittance and residual impedance.

Compensation type is selected as follows.

1. Press the **CAL** key, and the '**COMPEN menu**' softkey.
2. Press the '**COMPEN NONE**' softkey (or send the **CMPT0** command) to select not to use the compensation function. Press the '**0S OFFSET**' softkey (or send the **CMPT1** command) to select the 0S offset compensation. Press the '**0, OFFSET**' softkey (or send the **CMPT2** command) to select the 0Ω offset compensation. Press the '**0S&0, OFFSET**' softkey (or send the **CMPT3** command) to select the 0S&0Ω offset compensation.

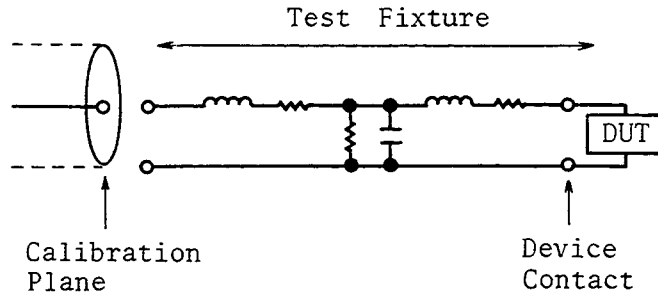

Figure 4-5. 0S/0Ω Offset Compensation

4-8-5. PORT EXTENSION

When the 50Ω coaxial cables are used to extend calibration plane to the network (or device) under test, the port extension can offset the phase shifts due to the extension cables. Port extension compensates for phase shift by calculation using the extension length as the parameter, it doesn't compensate for signal attenuation due to the port extension. The port extension length data is not cleared or changed, even if the 4195A's configuration is changed. So it is necessary to clear and enter the length data when the measurement setup is changed.

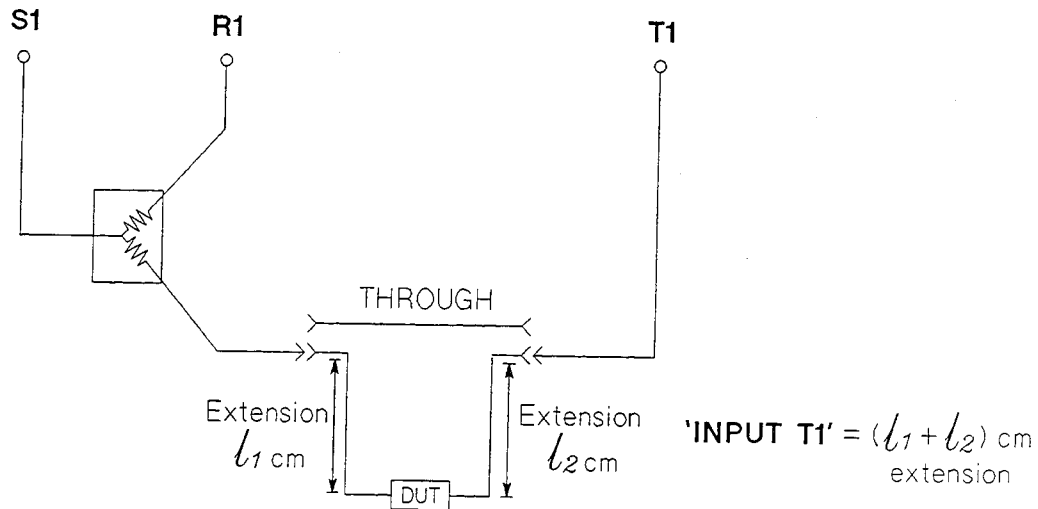

Figure 4-6. INPUT T1 Port Extension Example

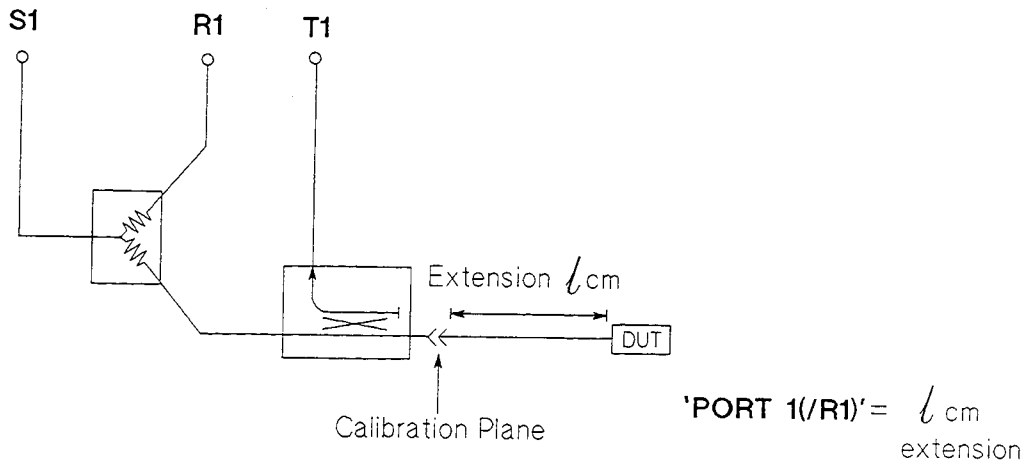

Figure 4-7. PORT 1 Extension Example

Port extension length data is entered by the following procedure.

1. Press the **CAL** key and the '**PORT EXTENS**' softkey.
2. Press the softkey corresponding to ports required extension.

For example, press the '**INPUT T1**' softkey for **T1** port extension as shown in Figure 4-6, press the '**PORT 1(/R1)**' softkey for **CHANNEL 1** port extension as shown in Figure 4-7. The currently set extension length will be displayed on the keyboard input line.

3. Enter the extension length (in cm, -999.99 cm to +999.99 cm) and press the **ENTER/EXECUTE** key.
4. Repeat steps 2 and 3 for all ports which require extension.
5. Press the softkey corresponding to ports required no extension.

6. Enter **0** and press the **ENTER/EXECUTE** key for no extension ports.
7. Press the 'return' softkey.
8. Press the '**PORT EXT on off**' softkey so that **on** is intensified **green**.

4-8-6. CALIBRATION HINTS

Here are some hints for obtaining accurate calibration.

1) Stimulus Settings/Receiver Settings and Calibration

For the most accurate calibration, perform the calibration with the same stimulus and receiver settings as will be used in the actual measurement.

Once the calibration/compensation are performed, calibration/compensation data will be stored into the dedicated registers for all points in the frequency sweep range, so that accurate measurements can be performed.

When calibration is performed using the full frequency span sweep setting (10 Hz to 500 MHz), all measurements can be corrected within a certain accuracy, even if the frequency range is changed or the sweep parameter is changed.

When Calibration has been Performed in the Frequency Sweep Mode:

All frequency sweep measurements are correctable. If a measurement frequency is within the calibrated frequency range, the calibration data is calculated using interpolation. If a measurement point is out of the calibrated frequency range, the calibration data of the closest frequency is used.

All DC source sweep and oscillator level sweep measurements are correctable. The constant frequency (Spot Frequency) calibration data is used. If the spot frequency is not one of the calibrated frequencies, the calibration data is calculated in the same manner as for frequency sweep measurements.

When Calibration has been Performed in the DC Source Voltage or Oscillator Level Sweep Mode:

Any measurement is correctable until the sweep parameter is changed to frequency. The calibration data taken at certain stimulus/receiver settings is used for the succeeding measurements, even if some the stimulus/receiver settings are changed.

If the sweep parameter is changed to frequency all the calibration data will be lost and correction is automatically turned off.

NOTE

Once the stimulus setting is changed from the settings used for calibration, **Cint** will be displayed in the function area of the screen when the calibration data is calculated using interpolation, **Cor?** will be displayed when a measurement point is out of the calibrated frequency range.

2) Calibration Data/Compensation Data Storage

The current calibration data is lost when a new calibration is performed, or when the 4195A is turned off. To save the calibration data, it must be saved on a flexible disc using the built-in flexible disc drive. Turn on the correction for selected calibration and save the instrument settings to the disc using the **save-state** function. If correction is not turned on, the calibration data will not be saved.

The impedance configuration's $0S/0\Omega$ offset compensation data is also saved only when the impedance configuration's correction is turned on.

Port extension length data is saved in all cases, even if the port extension is turned off.

NOTE

All of the calibration standards' values are stored on the disc in all cases and are also saved in the 4195A's battery backed-up memory.

3) Calibration Data Independence between Configurations

The 4195A's calibration data is stored in its 32 calibration array registers. All of the calibration registers are used when the 4195A is in the S-Parameter configuration. The calibration registers for the Network and Impedance configuration are shared with the S-Parameter configuration calibration registers as follows.

Network-transmission calibration registers	: shared with S11 calibration
Network-reflection calibration registers	: shared with S21 calibration
Impedance calibration registers	: shared with S22 calibration

(S12 calibration registers are used independently.)

If you switch the configuration between the Network-transmission, Network-reflection and Impedance, the registers are used and the proper calibration is performed. Once the configuration is changed to S-Parameter and all of the S-Parameter calibration is performed, the Network and Impedance calibration data will be lost, because the shared registers are overwritten.

The port extension extension length data is the same for all configurations. If port extension is turned **ON** in one configuration, it will be turned **ON** for the other configurations also.

Impedance configuration's $0S/0\Omega$ offset compensation data is not destroyed when the other configurations are calibrated.

4-9. STIMULUS SETTINGS

The 4195A has three parameters which can be swept -- frequency, source amplitude, and DC voltage. One of three parameters must be selected as the sweep parameter, and the other two parameters will be held at a constant value.

The sweep parameter point values are automatically stored in the X register. The X register is a read only array register with a maximum of 401 elements.

4-9-1. SELECTING SWEEP PARAMETER

There are five selections to choose from when selecting the sweep parameter -- frequency, DC voltage, source amplitude in volts, source amplitude in dBm, and source amplitude in dB μ V. Table 4-8 lists sweep parameter selections.

Table 4-8. Sweep Parameter Selection

Sweep Parameter	Unit	Softkey	Command
Frequency	Hz	'FREQ'	SWP1
DC Voltage	Vdc	'DC BIAS (V)'	SWP2
Oscillator Level	Vrms	'OSC LVL (V)'	SWP3
Oscillator Level	dBm	'OSC LVL (dBm)'	SWP4
Oscillator Level	dB μ V	'OSC LVL (dB μ V)'	SWP5

4-9-2. SPECIFYING THE SWEEP RANGE

The **START**, **STOP**, **CENTER**, and **SPAN** keys are used to specify the sweep range. Table 4-9 lists the sweep parameter ranges.

Table 4-9. Sweep Parameter Settable Range

Sweep Parameter	Minimum	Maximum	Resolution
Frequency (Hz)	1 mHz	500 MHz	1 mHz
DC Voltage (Vdc)	-40 V	+40 V	0.01 V
Oscillator Level (Vrms)	707 μ V	1.26 V	1%
Oscillator Level (dBm)	-50 dBm	+15 dBm	0.1 dB
Oscillator Level (dB μ V)	+57 dB μ V	+122 dB μ V	0.1 dB

NOTE

When the Oscillator Level sweep parameter is selected, the maximum sweep span ratio (ratio between START and STOP) is 20 (26 dB).

4-9-3. SELECTING SWEEP TYPE

There are two sweep types -- linear and log (commands are SWT1 and SWT2, respectively). When linear sweep is selected, the difference between two sequential measurement points is the same for all points. When log sweep is selected, the ratio between two sequential measurement points is the same for all points.

NOTE

When the sweep parameter is DC voltage and the sweep type is Log, the polarity of the START and STOP voltage must be the same.

When the sweep parameter is set to dBm or dBuV unit of oscillator level sweep, Log Sweep cannot be selected.

4-9-4. NUMBER OF MEASUREMENT POINTS

The maximum number of measurement points per sweep is 401, the number of elements in X register. In the spectrum configuration, the number of points set relate only to the display points, not to the actual measurement points.

To set the number of measurement points from the front panel, perform the following procedure.

1. Press the **SWEEP MENU** key, and the 'more 1/2' and 'No. of POINTS' softkeys, **NOP=** will be displayed on the keyboard input line.
2. Enter the required number of points using the number keys, and press the **ENTER/EXECUTE** key.

NOTE

When the sweep type is linear, specifying the step size also changes the number of measurement points. Changing the number of points or the step size will not cause the START and STOP values to change.

4-9-5. SWEEP TIME

The minimum sweep time is automatically calculated and set from other stimulus and receiver settings. When you want to increase the sweep time, perform the following steps.

1. Press the **MENU** key, the '**RESOLUTN menu**' softkey, and the '**SWEEP TIME**' softkey. **ST=** (currently set sweep time) **SEC** will be displayed on the keyboard input line.
2. Enter the required sweep time using the **ENTRY** keys or the **up/down** arrow keys.

NOTE

You cannot decrease the sweep time to be less than the AUTO setting.

4-9-6. NON-SWEEP PARAMETERS

In the frequency sweep mode, source amplitude and DC voltage are set to selected constant values. In a source amplitude sweep, the frequency and DC voltage are set to selected constant values. In a DC voltage sweep, the frequency and source amplitude are set to selected constant values.

To enter the constant frequency from the front panel, perform the following procedure.

1. Press the **SWEEP MENU** key, and the '**more 1/2**' and '**SPOT FREQ**' softkeys. Then **FREQ=** will be displayed on the keyboard input line.
2. Enter the selected constant frequency using the **ENTRY** area keys.

Use the following procedure to set the source amplitude from the front panel.

1. Press the **CHANNEL 1 SOURCE AMPLITUDE** key or the **CHANNEL 2 SOURCE AMPLITUDE** key. **OSC1=** or **OSC2=** will be displayed on the keyboard input line, respectively.
2. Enter the selected constant source amplitude using the **ENTRY** area keys or the **arrow up/down** keys.

NOTE

Select as high a source amplitude as possible to obtain the widest dynamic range, low noise, and the most stable measurements, but be sure the network under test and the 4195A's circuit is not overloaded. If the characteristics of the network under test is input power dependent, select the appropriate measurement amplitude.

Use the following procedure to set the DC voltage from the front panel.

1. Press the **DC SOURCE LEVEL** key, **BIAS=** will be displayed on the keyboard input line.
2. Enter the selected constant DC voltage using **ENTRY** area keys.

4-10. RECEIVER SETTINGS

4-10-1. INPUT RANGE

The 4195A input range (the maximum input power which does not cause the 4195A's internal circuit to saturate or distort the signal) for each of the R1, T1, R2, and T2 inputs is determined by the combination of the INPUT ATTENUATOR setting and the IF RANGE selection. Input attenuators are furnished at each of the four inputs. The IF range selection affects all four inputs. Tables 4-10 and 4-11 list input range values for the SPECTRUM configuration and the other configurations.

Table 4-10. Spectrum Configuration Input Ranges

Input Attenuation	IF Range Normal	IF Range Low Distortion	IF Range High Sensitivity
0 dB	-20 dBm	-30 dBm	-40 dBm
10 dB	-10 dBm	-20 dBm	-30 dBm
20 dB	0 dBm	-10 dBm	-20 dBm
30 dB	+10 dBm	0 dBm	-10 dBm
40 dB	+20 dBm	+10 dBm	0 dBm
50 dB	+20 dBm	+20 dBm	+10 dBm

Table 4-11. Input Ranges for other than Spectrum Configuration

Input Attenuation	IF Range Normal	IF Range High Sensitivity
0 dB	-10 dBm	-20 dBm
10 dB	0 dBm	-10 dBm
20 dB	+10 dBm	0 dBm
30 dB	+20 dBm	+10 dBm
40 dB	+20 dBm	+20 dBm
50 dB	+20 dBm	+20 dBm

CAUTION

The maximum allowable input signal power is +30 dBm and ± 7 V DC for each input. Do not input AC power or DC voltage exceeding these maximum levels.

There are three modes for the IF range as follows.

- Normal mode : is normally used.
- Low Distortion mode : reduces distortion within the 4195A and is used for low distortion measurements.
- High Sensitivity mode : reduces the internal noise of the 4195A and is suitable for measurement of low level signals.

To select the IF Range, press the **SPECIAL FUNCTION MORE** key and **'IF RANGE'** softkey. The IF Range selection softkey labels are displayed and the selected IF Range is intensified. Table 4-12 lists IF Range selection commands.

Table 4-12. IF Range Selection

Spectrum	Other	Command
Normal Low Distortion High Sensitivity	Normal High Sensitivity ---	IRNG1 IRNG2 IRNG3

To set the input attenuation, press the **REF ATTEN** or **TEST ATTEN** key above the input connectors, the currently set attenuation will be displayed on the keyboard input line. Press the **up/down arrow** keys. (When any of **REF ATTEN** or **TEST ATTEN** keys are pressed, the IF Range selection softkey will be displayed.) Table 4-13 lists input attenuator setting commands.

Table 4-13. Input Attenuators

Input	Command
R1	ATR1 =
T1	ATT1 =
R2	ATR2 =
T2	ATT2 =

NOTE

Select as sensitive an input range as possible to obtain the lowest noise and the most stable measurements. The 4195A internal circuit must not overload or saturate thereby causing distortion of the measurement signal.

4-10-2. RESOLUTION BANDWIDTH

The 4195A has eleven possible Resolution Bandwidth selections from 3 Hz to 300 kHz in 1, 3 ... steps. The wider resolution bandwidth settings provide the fast measurements. The narrower resolution bandwidth settings provide the lowest noise, and most stable measurements.

NOTE

For resolution bandwidths of 100 Hz and greater, the 4195A uses an internal analog resolution bandwidth filter. For resolution bandwidths less than 100 Hz, the signal is digitally filtered for equivalent bandwidths of 30 Hz, 10 Hz, and 3 Hz.

Resolution Bandwidth AUTO Selection

When the indicator in the **AUTO** key is **ON**, the resolution bandwidth is selected automatically.

When the 4195A is in the linear frequency sweep mode, the resolution bandwidth is determined by the frequency SPAN to satisfy the following formula.

$$\text{SPAN} \div 130 \geq \text{RBW} > \text{SPAN} \div 390$$

When the 4195A is in the log frequency sweep mode, the resolution bandwidth is determined by the measurement frequency at each measurement point.

When the 4195A is not in the frequency sweep mode (or zero frequency span), the resolution bandwidth is determined by the measurement frequency. Table 4-14 lists the measurement frequencies and the corresponding auto selection resolution bandwidths.

Table 4-14. Resolution Bandwidth AUTO Selection

Measurement Frequency		Resolution Bandwidth
0.001 Hz to	999.999 Hz	3 Hz
1 000.000 Hz to	2 999.999 Hz	10 Hz
3 000.000 Hz to	9 999.999 Hz	30 Hz
10 000.000 Hz to	29 999.999 Hz	100 Hz
30 000.000 Hz to	99 999.999 Hz	300 Hz
100 000.000 Hz to	299 999.999 Hz	1 kHz
300 000.000 Hz to	999 999.999 Hz	3 kHz
1 000 000.000 Hz to	2 999 999.999 Hz	10 kHz
3 000 000.000 Hz to	9 999 999.999 Hz	30 kHz
10 000 000.000 Hz to	29 999 999.999 Hz	100 kHz
30 000 000.000 Hz to	500 000 000.000 Hz	300 kHz

4-10-3. VIDEO FILTER

The 4195A video filter decreases measurement fluctuation. When the video filter is turned **ON**, the 4195A performs four measurements and displays the average of the four measurements as the result. To turn **ON** the video filter, press the **VIDEO FILTER** key (command is **VFTR1**), the key indicator will turn **ON**. To the video filter **OFF**, press the **VIDEO FILTER** key again (command is **VFTR0**), the key indicator will toggle **OFF**.

4-11. MEASUREMENT TRIGGERING

The 4195A continuously repeats sweep measurements when turned on. This is because (1) the single point measurement trigger mode is set to Internal and (2) the sweep trigger mode is set to Continuous sweep as the default setting.

4-11-1. SWEEP TRIGGER MODE

There are three sweep trigger modes. When the 4195A set to the CONTINUOUS mode (command is SWM1), the 4195A automatically restarts the sweep measurement after the measurement at the last point is completed. When the 4195A is set to the SINGLE sweep mode (command is SWM2), the 4195A stops measurement after the last point is measured, and waits until the **TRIG/RESET** key is pressed (or the **SWTRG** command is executed). When the 4195A is set to the MANUAL sweep mode (command is SWM3), the MANUAL marker (looks the same as the o marker) appears on the screen and measurements are performed only at the selected marker point. The MANUAL marker can be moved by rotating the **MARKER/LINE CURSOR** knob.

To select the sweep trigger mode, press the **SWEEP MENU** key, and the 'TRIGGER menu' softkey, and select and press a softkey. (When the **TRIG/RESET** key is pressed, the softkey labels will change to the sweep trigger mode selection softkeys.)

NOTE

The MANUAL marker can be moved by entering desired measurement point data into the MANUAL register using the blue shifted alphabetical keys and the **ENTRY** keys. For example to select 10 MHz/V, enter:

[Blue Shift] [M] [A] [N] [U] [A] [L] [=] [1] [0] [MHz/V]

4-11-2. SINGLE POINT TRIGGER MODE

The 4195A sweep measurement is a set of (maximum of 401) sequential single-point-measurements. When the single point measurement trigger mode is set to internal (command is TRGM1) the 4195A performs the sweep measurement automatically. When the single point measurement trigger mode is set to external (command is TRGM2) the 4195A performs a single point measurement, and waits until the 'PT MEAS TRIG' softkey is pressed, the **TRIG** command is sent, or an external trigger pulse is applied to the **EXT TRIGGER** connector.

In order to select the single point measurement trigger mode, press the **SWEEP MENU** key, the 'TRIGGER menu' softkey, and press the 'TRG MODE int ext' softkey. Every time the softkey is pressed, **int** and **ext** are alternately intensified. (When the **TRIG/RESET** key is pressed, the sweep trigger mode selection softkeys will be displayed.)

4-11-3. EXTERNAL TRIGGERING

The 4195A's single point measurement can be triggered externally by connecting an external device to the **EXT TRIGGER** connector on the control unit rear panel and setting the trigger mode to the external mode. The 4195A is triggered and makes a single point measurement each time a positive-going TTL level pulse is applied at the **EXT TRIGGER** connector. External triggering can also be accomplished by alternately grounding (to chassis ground) and opening the center conductor of the **EXT TRIGGER** connector.

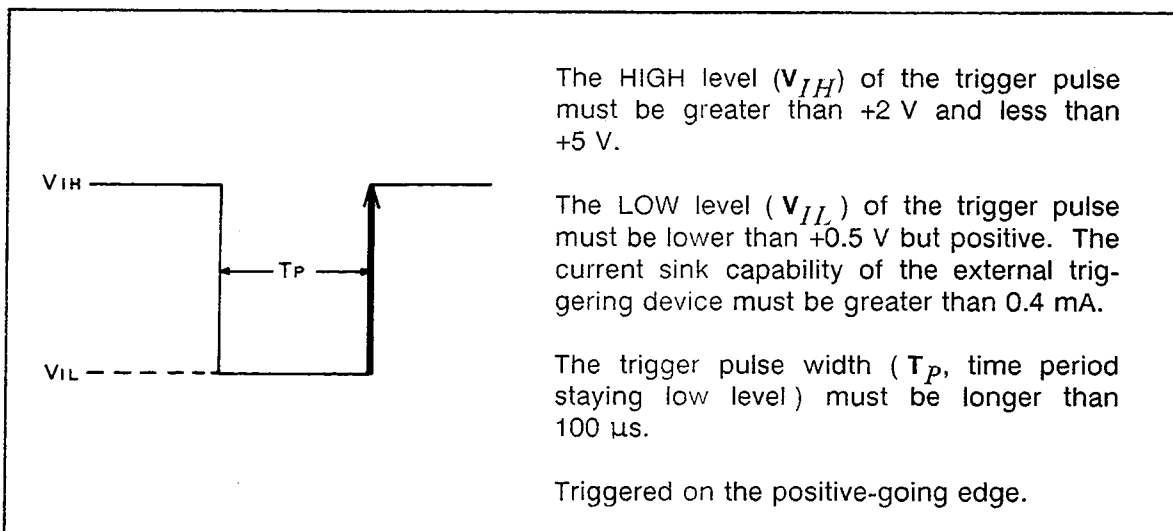

Figure 4-8. External Trigger Pulse

NOTE

A trigger signal will be ignored if it is applied before a single point measurement in progress is completed.

4-12. MEASUREMENT DATA DISPLAY

This paragraph explains the HP 4195A's display capabilities.

4-12-1. MEASUREMENT DATA STORAGE

Data A and B stored in array registers A and B, respectively, are plotted on the 4195A's screen. The details of array registers A and B are described in Section 5. Data B is not measured during spectrum measurement, so the data in register B is not overwritten.

NOTE

The sweep points data is stored in array register X.

4-12-2. DISPLAY FORMAT

The HP 4195A has five display formats to choose from: Rectangular X-A&B, Rectangular A-B, TABLE, Smith chart, and Polar chart.

1. Rectangular X-A&B

The Rectangular X-A&B display format displays data A and B on the vertical axis, and the sweep parameter (data X) on the horizontal axis. Data A is displayed in yellow, and data B is displayed in greenish blue. The Rectangular X-A&B display format is available in all of the 4195A's measurement configurations (Network, Spectrum, Impedance, and S-Parameter).

2. Rectangular A-B

In the Rectangular A-B display format the value of data A is read on the horizontal axis, and the value of measurement data B is read on the vertical axis.

3. TABLE

The TABLE display format lists the measurement data (data A and B) and the sweep parameter (data X) in a tabular table of numeric data. The TABLE display format is available for all of the 4195A's measurement configurations.

4. Smith Chart

The Smith Chart display format displays the data on a Smith Chart, and is available for Network or S-Parameter measurements (S11, S12, S21, or S22). When this display format is selected for a Network, S12, or S21 measurement, the measurement parameter is changed to "T/R Re-Im". For a S11 or S22 measurement, the measurement parameter is changed to "Tx-Ty". Data A and B , R(Ω), X(Ω), Ls(H), and Cs(F), can be read using a marker. Data R, X, Ls and Cs are stored in registers **SMTHR**, **SMTHX**, **SMTHL** and **SMTHC**, respectively.

5. Polar Chart

The Polar Chart display format plots the data on a Polar Chart. The Polar Chart display format is available for Network, and S-Parameter measurements. When this display format is selected for Network (S12, or S21) measurement, the measurement parameter is changed to "T/R Re-Im". For S11 or S22 measurement, the measurement parameter is changed to " Tx-Ty ". Data A and B , Return Loss(dB), and VSWR, can be read using a marker. The Return Loss and VSWR data are stored in registers **RLOSS** and **VSWR**, respectively.

4-12-3. DISPLAY CONTROL KEY/SOFTKEYS

Three DISPLAY area front panel keys (**DISPLAY**, **SCALE REF**, and **VIEW**) are used to control the 4195A's display. When one of these keys is pressed, the softkeys used to control the display are displayed in the Softkey Area. To control the 4195A's operation by using an HP-IB controller, User Program, User Defined Function or Sweep End Function, use the command which corresponds to the softkey. The commands are included in APPENDIX D, Softkey Tree. Refer to APPENDIX D, Softkey Tree, before going on to the following paragraphs.

4-12-4. CHANGING THE DISPLAY FORMAT

1. Selecting the Display Format

To select the display format, press the **DISPLAY** key to display the softkeys used to set the display format, and press the appropriate softkey.

2. Eliminate/Recall the Grid Display

To eliminate/recall the grid on the display, use the '**GRTCL on off**' softkey which toggles the grid **on** and **off**. When the '**GRTCL on off**' softkey is set to **off**, the grid will be erased. To recall the grid, set the '**GRTCL on off**' softkey to **on**. This capability is available for all display formats except for the TABLE display format which does not use a grid.

4-12-5. SELECTING THE DISPLAY DATA

To select the data displayed on the 4195A's screen, use the **'TRACE A on off'** and **'TRACE B on off'** softkeys. For example, to display only data A when both data A and B are being displayed, press the **'TRACE B on off'** softkey to toggle data B off. The **'off'** on the softkey label will change to intensified green, and data B will be erased from the screen (the data in the DATA B array is not disturbed). This capability is available for all display formats except for the TABLE display which does not use a grid.

NOTE

In the rectangular A-B, Smith and Polar display formats, the **'TRACE A on off'** and **'TRACE B on off'** softkeys work together (ie. When the **'TRACE A on off'** softkey is set to **'on (off)'**, the **'TRACE B on off'** softkey is set to **'on (off)'** at the same time).

NOTE

During spectrum measurement, the **'TRACE A on off'** softkey is set to **'on'**, and the **'TRACE B on off'** softkey is set to **'off'**, as the default settings. For all measurement functions except for the spectrum measurement function, both softkeys are set to **'on'**.

4-12-6. SETTING THE GRID SCALE

In the rectangular X-A&B, or A-B display formats, the data A and B scales can be set to **Linear** or **Logarithmic**.

To set the grid scale for data A(B) to **'log'** when it is set to **'lin'**, press the **'A(B) SCALE lin log'** softkey which will toggle the scale from **lin** to **log**. The **'log'** on the softkey label will change to intensified green, and the grid scale will change to a **logarithmic** scale.

NOTE

In the rectangular X-A&B display format, the scale of the vertical axis is selected using the **'SCALE for A for B'** softkey. If **'for A'** on this softkey label is intensified green, the grid scale for data A is displayed.

4-12-7. SETTING THE GRID RANGE

1. Setting the Grid Range for the Rectangular X-A&B, A-B and Polar Displays

In the **RECTANGULAR X-A&B** and **A-B** display formats, the displayed grid range can be set by using the 'A(B) REF LEVEL' and 'A(B) BOTTOM' softkeys, or the 'A(B) REF LEVEL' and 'A(B) /DIV' softkeys.

In the **POLAR** chart, the grid range is set using the 'REF LEVEL' and '/DIV' softkeys. The **BOTTOM** level is the center point of a polar chart, so the bottom level is always 0.

NOTE

The difference in scale between a circle on a polar chart and the next larger or smaller diameter circle displayed on the screen is 2 divisions (**DIV**).

Figure 4-9 shows the position of **REF**, **DIV**, and **BTM** (**BOTTOM**).

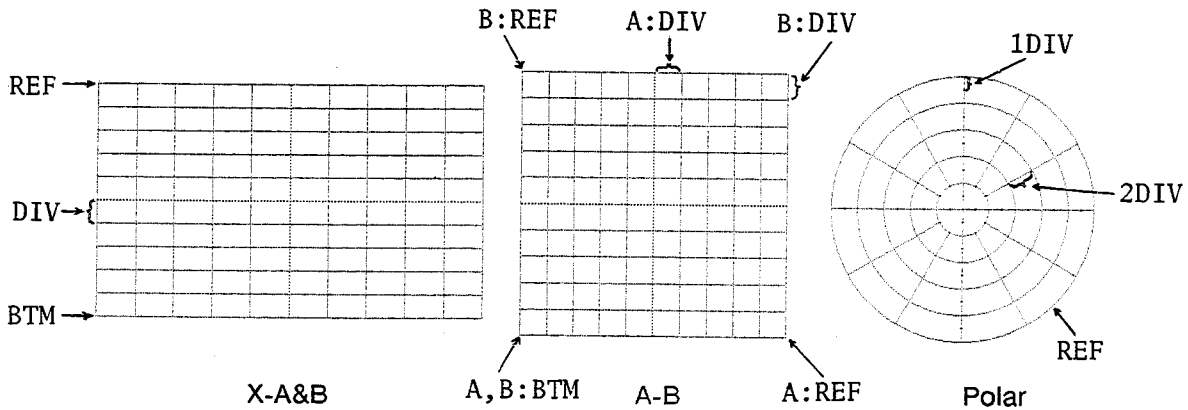

where **REF**: Reference Level (Maximum Level)
DIV: Division of Grid
BTM: Bottom Level (Minimum Level)

Figure 4-9. Grid Range

The values of **REF**, **BOTTOM** and **DIV** can be within the following ranges.

Linear scale

$1E-37 \leq$	$ \text{REF} $	$\leq 9.999E+37$ or 0
$1E-37 \leq$	$ \text{BOTTOM} $	$\leq 9.999E+37$ or 0
$5E-36 \leq$	$ \text{DIV} $	$\leq 9.999E+37$

Logarithmic scale

$1.001E-37 \leq$	$ \text{REF} $	$< 9.999E+37$
$1E-37 \leq$	$ \text{BOTTOM} $	$< 9.999E+37$

NOTE

For the logarithmic scale, the grid range is set using **REF** level and **BOTTOM** level.

To set the reference level (the maximum value represented by the grid), press the '**A(B) REF LEVEL**' or '**REF LEVEL**' softkey to display "REF=" on the keyboard input line, and enter the reference value.

NOTE

The reference level can be set to any value, independent of any hardware (input range) settings.

If you set the grid range using the **BOTTOM** level (with REF level)

Use the '**A(B) BOTTOM**' or '**BOTTOM**' softkey to set the **BOTTOM** level (the minimum grid value).

If you set the grid range by using the **DIV** value (with REF level)

Use the '**A(B) /DIV**' or '**/DIV**' softkey to set the grid division.

2. Setting the Smith Chart's Grid Range

The **SMITH CHART**'s grid range is selected using the '**SCALE comp 2.0**', '**SCALE normal**', '**SCALE exp 0.2**' or '**SCALE exp 0.1**' softkeys. The center point of a **SMITH CHART** circle is 0 (zero) for all grid ranges. Figure 4-10 shows the Smith Chart's grid ranges.

- SCALE normal** Set the reference circle (the outer most circle) = 1 (ie. Standard Smith Chart).
- SCALE comp 2.0** Set the reference circle = 2
- SCALE exp 0.2** Set the reference circle = 0.2
- SCALE exp 0.1** Set the reference circle = 0.1

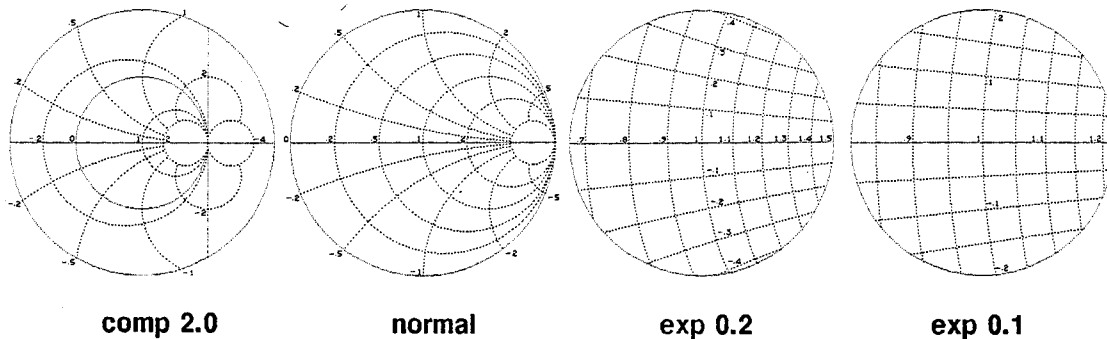

Figure 4-10. Smith Chart Grid Range

3. AUTO Scaling

The '**A AUTO SCALE**' or '**B AUTO SCALE**' softkey (the '**AUTO SCALE**' softkey for Smith and Polar Charts), can be used to automatically optimize the displayed grid range.

(1) Rectangular X-A&B

When the '**A AUTO SCALE**' or '**B AUTO SCALE**' softkey is pressed, **AUTO** scaling is performed on data A or B, respectively.

(2) Rectangular A-B

AUTO scaling is performed to both sets of data, when either the '**A AUTO SCALE**' or '**B AUTO SCALE**' softkeys is pressed.

(3) Polar Chart

The **REF** level is optimized for the range of data.

(4) Smith Chart

The optimum grid range for the range of data is selected.

4-12-8. SUPERIMPOSE SUBTRACE C, D

The 4195A can superimpose the data stored in registers C and D on the screen. The details of the registers C and D, are described in Section 5. The softkeys to use this capability are displayed by pressing the **VIEW** key.

The '**VIEW C on off**' and '**VIEW D on off**' softkeys are used to plot data **C** and **D** on the screen. When the '**on**' of the softkey label changes to intensified **green**, the trace is displayed.

When superimposing traces C and D, the grid range of trace C and D are the same as the grid range of traces A and B, respectively.

To store measurement data A and B in the C and D registers, respectively, press the '**STORE A,B→C,D**' softkey.

To swap data A with the data in register C, and to swap data B with the data in register D, press the '**A,B←→C,D**' softkey.

NOTE

In the Rectangular A-B, Polar and Smith display formats, the '**VIEW C on off**' and '**VIEW D on off**' softkeys work together (when the '**on**' of the '**VIEW C on off**' softkey label changes to intensified **green**, the '**on**' of the '**VIEW D on off**' softkey label will change to intensified **green** at the same time).

Figure 4-11 shows the four data traces as a result of using subtraces C, and D.

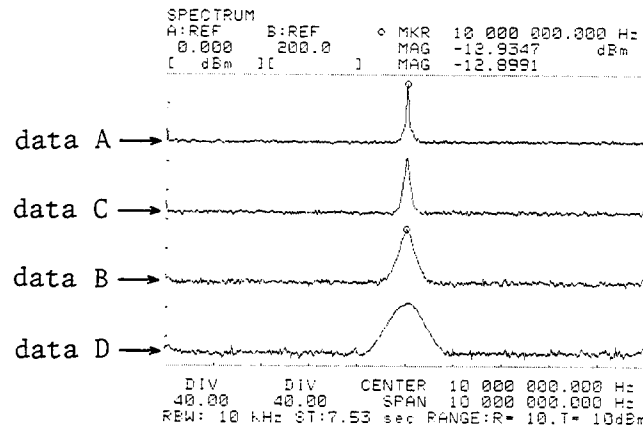

Figure 4-11. Superimpose Subtraces C and D

4-12-9. STORAGE FUNCTION

The **STORAGE** function is used to store measurement data traces on the screen. This function can be used by setting the '**STORAGE on off**' softkey to **on**. Stored traces can be redisplayed on the screen on the graticule. Data stored in registers data A and B is new measurement data only (the old measurement data is stored only on the display as a trace). When this softkey is set to **off**, only the new data is displayed, all other traces are erased.

4-12-10. PHASE DATA EXPANSION

The phase display is selected using the '**θ DISP normal**' or '**θ DISP expand**' softkeys. When the '**θ DISP normal**' softkey is **green**, the phase plot wraps around every 360°. When the '**θ DISP expand**' softkey is **green**, the phase plot is continuous (expanded).

4-13. MEASURED DATA READ OUT/ANALYSIS (MARKER/LINE CURSOR)

The MARKER/LINE CURSOR capability is used to analyze measurement data, and to set the sweep range, etc.

4-13-1. MARKER/LINE CURSOR MODES

The following MARKER/LINE CURSOR modes are available.

1. o MARKER mode

In the **o marker** mode, the o marker is available for all display formats (X-A&B, A-B, Polar, Smith and Table). The softkeys used to set the sweep range, peak search, read the noise level in dB/Hz and etc., are provided. The marker displays the reading value of the measurement data, and the value of a sweep point.

2. o & * MARKERS mode

In the **o & * markers** mode, the o marker and * marker are available for all display formats. All functions available in the **o marker** mode are available in the **o & * markers** mode. The markers are used to display the reading value of the measurement data, or the **difference** between the values at the markers.

3. LINE CURSOR mode

In the **Line Cursor** mode, the line cursor is available for the X-A&B display format. The line cursor is used to read the Quality Factor, etc. The line cursor displays the sweep value of the left and right most points of intersection with the measurement data, or the distance between these points in horizontal scale units, with the vertical value (line cursor position).

4. o MARKER & LINE CURSOR Mode

In the **o marker & Line Cursor** mode, the o marker and line cursor are available in the X-A&B display format (the o marker is available in all display formats). Most functions of the **Line Cursor** mode can be used. Also, several functions in the **o marker** mode can be used. The marker and line cursor give the reading value of the measurement data with the o marker's sweep data, or the vertical difference between o marker and line cursor with the width between the left most and right most points of intersection of the line cursor and the measurement data, and etc.

5. MARKER/LINE CURSOR OFF Mode

All MARKER/LINE CURSOR capabilities are disabled.

NOTE

In all display formats except for rectangular X-A&B, the line cursor is not displayed, but the softkeys still function normally. So, the line cursor is available for use in User Programs or under HP-IB control.

4-13-2. MARKER AREA

The MARKER area displays the marker's position in measurement data units. Measurement data A and B, and the sweep point data (data in the array register X) are displayed in the MARKER area. The position of the marker area is different for each display format. Figure 4-12 shows the location of the marker area for the Rectangular X-A&B display format.

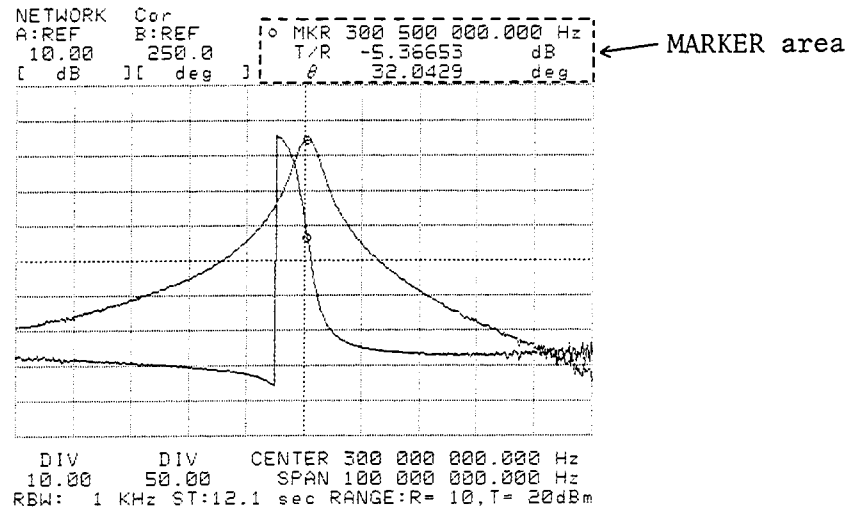

Figure 4-12. Marker Area Location

4-13-3. CHANGING THE MARKER/LINE CURSOR MODE

At turn on the MARKER/LINE CURSOR mode is set to the **o** marker mode. Press the **MODE** key to display the softkeys used to change the MARKER/LINE CURSOR mode. The following softkeys will be displayed in the Softkey Area. Press a softkey to select the mode you want.

'o MKR' softkey	o marker mode
'o & * MKRS' softkey	o & * markers mode
'LINE CURSOR' softkey	Line Cursor mode
'o MKR & LCURS' softkey	o marker & Line Cursor mode
'off' softkey	marker/Line Cursor off mode

The softkeys used to control the marker function, are displayed in the softkey area when the **MKR→** key is pressed. When the Marker/Line Cursor mode is changed, press the **MKR→** key to display these softkeys.

4-13-4. CHANGING THE DATA DISPLAY FORMAT

The data display format (format of the data displayed in the MARKER area) is different in the Marker/L Cursor mode. This paragraph describes the X-A&B data display formats.

1. o Marker Mode

There are two data display formats in the **o marker** mode: RDG display and NOISE display.

In the RDG display format, the sweep data and the reading value of the measurement data at the position of the **o** marker are displayed in the marker area, as follows.

((RDG display))

o MKR	300 000 000.000	Hz	(Sweep data)
T/R	-5.00000	dB	(Reading for data A)
θ	-50.0000	deg	(Reading for data B)

To change the data display format to the NOISE display, press the '**NOISE on off**' softkey. This data display format is available while this softkey is set to '**on**'. The displayed data is the noise level calculated at a bandwidth of 1 Hz. This softkey is available only for measurement data A, when the measurement parameter is set to dBm, dB μ V or μ V at the spectrum measurement.

((NOISE display))

o MKR	300 000 000.000	Hz	(Sweep data)
o NOISE	-120.000	dBm/Hz	(Noise level)

2. o & * Markers Mode

Five data display formats are available in the **o & * markers** mode: RDG display, NOISE display, Δ display, Δ -NOISE display and REF display.

When the ' **Δ mode on off**' and '**NOISE on off**' softkeys are set to **off**, the RDG display is selected.

To change the format to the NOISE display, set the '**NOISE on off**' softkey to **on**.

In the RDG and NOISE displays, the data displayed in the MARKER area is the data for the active marker (**o** marker or ***** marker) which is selected using the '**active oMKR *MKR**' softkey. For example, if the '**oMKR**' on this softkey label is **green**, the data marked by the **o** marker is displayed in the marker area.

When the ' **Δ mode on off**' softkey is set to **on**, the data display format is changed to the Δ display. In this data display format, the **difference** value (the difference value between the **o** marker and ***** marker) is displayed in the marker area, as follows.

((Δ display))

Δ MKR	1 000.000	Hz	(Difference for Sweep data)
Δ T/R	-4.00000	dB	(Difference for data A)
$\Delta\theta$	25.0000	deg	(Difference for data B)

When the '**Δ mode on off**' and '**NOISE on off**' softkeys are set to **on**, the display format is changed to the Δ-NOISE display, as follows.

((Δ-NOISE display))

ΔMKR	1000000.000	Hz	(Difference for Sweep data)
*NOISE	-60.0000	dBm/Hz	(Noise level)

When the Δ mode is set to '**on**', the * marker is active, and the o marker is set to the reference marker. To read the data point indicated by the o marker (reference marker), press the '**o REF read**' softkey. Then the MARKER area is changed as follows. This softkey is available when the Δ mode is **on**.

((REF display))

o REF	100 000 000.000	Hz	(Sweep data)
REF A	-3.00000	dB	(Reading of o marker for data A)
REF B	25.0000	deg	(Reading of o marker for data B)

NOTE

Δ mode is not available in the table display format.

3. Line Cursor Mode

Three data display formats are available in the **Line Cursor** mode: L-R display, WIDTH display, and Q display.

NOTE

The data displayed in the marker area is selected using the '**LCURS for A for B**' softkey.

When the '**WIDTH on off**' softkey is set to **off**, the L-R value (sweep data value at the left and right most points of intersection between line cursor and the plotted measurement data) is displayed as the sweep data. The L-R display is shown below.

((L-R display))

CRS_A	-30.0000	dB	(Measurement data)
LEFT	1 000	Hz	(Left Most data sweep point)
RIGHT	490 000 000	Hz	(Right Most data sweep point)

When the '**WIDTH on off**' softkey is set to **on**, the width (the distance, in horizontal measurement units, between the left and right most points of intersection) is displayed. The WIDTH display is shown below.

((WIDTH display))

CRS_A	-30.0000	dB	(Measurement data)
WIDTH	489 999 000	Hz	(Width of sweep data)

The Q display format displays the Quality Factor calculated by using the intersections between the line cursor and the plotted data, in the MARKER area, as follows. To read the Quality Factor, press the '**Q VALUE**' softkey.

((Q display))

CRS_A	-3.50000	dB	(Position of LCURS)
Q	100.0000000E+02		(Q Value)

4. o Marker & Line Cursor Mode

Eight data display formats are available in the **o marker & Line Cursor** mode: RDG display, L-R display, WIDTH display, Q display, Δ -L-R display, Δ -WIDTH display, Δ -Q display and REF display.

To select the RDG display, set the ' **Δ mode on off**' softkey to '**off**', and the '**active oMKR LCRS**' softkey to '**oMKR**'.

To select the L-R display, set the ' **Δ mode on off**' softkey to '**off**', the '**active oMKR LCRS**' softkey to '**LCRS**', and the '**WIDTH on off**' softkey to '**off**'.

To select the WIDTH display, set the ' **Δ mode on off**' softkey to '**off**', the '**active oMKR LCRS**' softkey to '**LCRS**', and the '**WIDTH on off**' softkey to '**on**'.

To change to the Q display, press the '**Q VALUE**' softkey. This data display format is available when the Line Cursor is active ('**LCRS**' on the '**active oMKR LCRS**' softkey is green).

The Δ -L-R display format displays the vertical **difference** between the **o** marker and line cursor, and the left and right most points of intersection as follows. To select this data display format, set the ' **Δ mode on off**' softkey to '**on**', and the '**WIDTH on off**' softkey to the '**off**'.

((Δ -L-R display))

Δ CRS_A	-3.00000	dB	(Difference data)
LEFT	100 000	Hz	(Left Most data sweep point)
RIGHT	490 000 000	Hz	(Right Most data sweep point)

The Δ -WIDTH display format displays the vertical **difference** between the o marker and line cursor, and the **distance** between the left and right most points of intersection, as follows. To select this data display format, set the ' Δ mode on off' softkey to on, and the '**WIDTH on off**' softkey to on.

((Δ -WIDTH display))

Δ CRS_A	-3.0000	dB	(Difference data)
WIDTH	489 900 000	Hz	(Width of sweep data)

When the Δ mode is set to 'on', and if '**Q VALUE**' softkey is pressed, the display format is changed to the Δ -Q display, as follows.

((Δ -Q display))

Δ CRS_A	-6.000	dB	(Difference data)
Q	1.800000000E+02		(Q Value)

When the Δ mode is set to 'on', the line cursor is active, and the o marker is set to the reference marker. To read the data at the o marker position (reference marker), press the '**o REF read**' softkey, then the MARKER area will change to the REF display. This softkey is available when the Δ mode is 'on'.

NOTE

Measurement data A or B can be displayed in the marker area using the '**MKR/LCRS for A for B**' softkey.

NOTE

Δ mode is not available in the table display format.

4-13-5. MOVING THE MARKER/LINE CURSOR

The marker and line cursor are moved by rotating the ROTARY knob on the front panel, or by pressing a softkey. The movable marker or line cursor are selected using the '**active oMKR *MKR**' or '**active oMKR LCRS**' softkeys. The softkeys used to move the marker are available for the data is selected using the '**MKR for A for B**', '**LCURS for A for B**', or '**MKR/LCRS for A for B**' softkeys, for all data display formats.

1. Moving to the Maximum Value

To move the marker or line cursor to the position with the maximum value, press the '**MKR→MAX**' softkey or the '**LCURS→MAX**' softkey, respectively. If this softkey is pressed in the o & * markers mode (active oMKR) the o marker will move to point 1 as shown in Figure 4-13.

2. Moving to the Minimum Value

To move the marker or line cursor to the position with the minimum value, press the **'MKR→MIN'** softkey or the **'LCURS→MIN'** softkey, respectively. If this softkey is pressed in the **o & * markers mode** (active *MKR), the * marker will move to point 2 as shown in Figure 4-13, (1).

3. Moving to the Average Value

To move the line cursor to the position with the average value for the measurement data, press the **'LCURS→AVRG'** softkey. If this softkey is pressed in the **o marker & Line Cursor mode**, the line cursor will move to position 3 as shown in Figure 4-13, (2).

4. Moving to the Next Peak

To move the marker to the next lower peak referenced to the current peak, press the **'NEXT PEAK'** softkey. If this softkey is pressed after the **'MKR→MAX'** softkey in the **o & * markers mode** (active oMKR), the o marker will move to point 4 as shown Figure 4-13, (1).

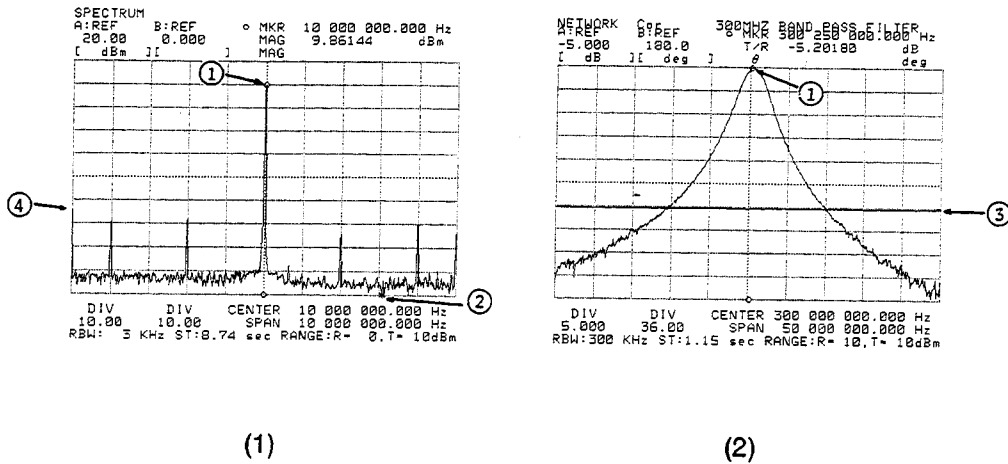

Figure 4-13. MKR→MAX, MIN, LCURS→AVRG and NEXT PEAK

5. Moving to an Entered Position

In the **Line Cursor mode** you can move the line cursor to any position. To move the line cursor to the **-30 dB position**, press the **'LCURS POSITION'** softkey, **-, 3, 0**, and the **ENTER** key (or enter the "LCURS=-30" command).

In the **o & * markers** mode you can move the ***** marker to a point which has a distance of the entered value from the **o** marker in the horizontal direction. If you want to move the ***** marker to the frequency point which is 100 MHz less than the value at the **o** marker's position, press the '**Δ VALUE entry**' softkey, **-, 1, 0, 0** and the **MHz** key (or enter "DMKR=-100MHz" command).

In the **o marker & Line Cursor** mode, you can move the line cursor to a position at some specified distance from the entered value from the **o** marker in the vertical direction. To move the line cursor to the position which is 3 dB less than the value at the **o** marker's position, press the '**Δ VALUE entry**' softkey, **-, 3** and the **dBm** key (or enter "DLCURS=-3DBM" command).

NOTE

The '**Δ VALUE entry**' softkey is available when the **Δ** mode is **on**.

In the **o marker** or **o & * markers** mode, you can move the marker to any sweep point by using the "MKR=" or "SMKR=" commands. If you want to move the **o** (or *****) marker to the 100 MHz point, enter the following command (press the Blue key, (**S**) **M, K, R, =, 1, 0, 0**, and **MHz** key).

MKR= 100 MHz (or SMKR= 100 MHz)

NOTE

When you enter the above command, you can enter the command without entering the units. (ex. MKR= 100M).

6. LMX, and LMN commands

Use the "**LMX(a)**" command to move the **o** marker to the first peak position, and the ***** marker to the last peak position within the specified range.

Use the "**LMN(a)**" command to move the **o** marker to the first valley position, and the ***** marker to the last valley position within the specified range.

These commands are available in the **o & * markers** mode.

LMX(a) and **LMN(a)** are used in connection with all array variables except for the X register.

ex) LMX(A), LMN(B) and etc.

NOTE

When only a peak or a valley exists within the specified range, the **o** marker moves to maximum or minimum point and ***** marker moves to the Sweep Stopping point. When no peak or valley exists, the **o** marker moves to Sweep Starting point and the ***** marker moves to Sweep Stopping point.

4-13-6. SETTING THE SWEEP AND GRID RANGE

You can use the 4195A's softkeys to set the marker's position to the start value, stop value, center value, and span value of the sweep range, and to the REF level of the grid range.

1. Using the Marker to Set the Sweep Starting Point

Press the **'MKR→START'** softkey to change the sweep starting value of the sweep range to the value at the marker.

2. Using the Marker to Set the Sweep Stopping Point

Press the **'MKR→STOP'** softkey to change the sweep stopping value of the sweep range to the value at the marker.

3. Using the Marker to Set the Sweep Center Point

Press the **'MKR→CENTER'** softkey to change the center value of the sweep range. This softkey is available only in the linear sweep mode.

4. Using the Markers To Set the Sweep Range

Press the **'MKRS→SPAN'** softkey to change the span of the sweep range to the values between the 0 marker and * marker.

5. Using the Marker to Set the Reference Level

Press the **'MKR→REF'** softkey to change the Reference Level (**REF**, maximum on the graph scale) to the vertical value at the marker.

4-14. INITIAL SETTINGS

The 4195A is initialized when the instrument is turned on, the CLEAR statement (device clear) is entered via HP-IB, or the PRESET key on the front panel is pressed ("RST" command is entered). The initialization method differences are shown in Table 4-15.

NOTE

Pressing the PRESET key is same as entering the "RST" command.

Table 4-15. Initialization Differences

Parameter	Turn on	CLEAR	PRESET
Measurement Configuration (N/S/I/S11/S12/S21/S22) ¹	YES ²	YES ²	NO ³
General Parameter	YES	YES	NO
Parameter couple to Measurement Configuration			
Network measurement	YES	YES	YES ³
Spectrum measurement	YES	YES	
Impedance measurement	YES	YES	
S11 measurement	YES	YES	
S12 measurement	YES	YES	
S21 measurement	YES	YES	
S22 measurement	YES	YES	
HP-IB Definition (addressable/talk-only)	YES ⁴	NO ⁵	NO
Single Variable Register	YES	NO ⁶	NO ⁶
Array Variable Register	YES	NO	NO
YES: initialized NO: not initialized			

NOTE: ¹ N, S, and I indicates Network, Spectrum, Impedance measurement configuration, respectively.

² The measurement configuration is set to Network.

³ The PRESET key ("RST" command) can initialize only the setting at the current measurement configuration, and not initialize the Measurement Configuration.

⁴ The HP-IB definition is set to ADDRESSABLE mode.

⁵ Before sending the CLEAR statement to the 4195A from the controller, the 4195A's HP-IB definition must be set to the "ADDRESSABLE" mode.

⁶ A part of the single variable register is initialized. Refer to paragraph 4-14-2.

4-14-1. INITIAL FUNCTION SETTINGS

1. General Parameter

Table 4-16 shows the initial setting of the general parameters, independent of the measurement configurations (Network, Spectrum, Impedance, S11, S12, S21, or S22). These parameters are initialized by all initialization methods.

Table 4-16. Initial Setting for General Parameter

Parameter	Initial Setting
Sweep Mode continuous/single/manual	continuous Single ¹
Sweep Type lin/log	lin
Sweep Direction up/down	up
Sweep Parameter	Frequency
Partial Sweep on/off	off
Programmed Points Table Measurement on/off	off
Table Number No.1/2/3/4	No.1
Trigger Mode internal/external	internal
Video Filter on/off	off
Graticule on/off	on
Phase Scale normal/expand	normal
Superimpose C and D on/off	off
Storage mode on/off	off
Marker/Line Cursor Mode	o Marker Mode
Available data A/B (effective data for marker action)	A
User Math A and B on/off	off
Sweep End Function A, B and C on/off	off
Partial Analysis on/off	off
Port Extension Correction on/off	off
Characteristics Impedance 50/75Ω	50Ω
Copy Mode	Dump Mode
Equivalent Circuit A/B/C/D/E	A
Status Byte Mask	Disable All Bits
Data Output Format	ASCII Format

NOTE: ¹ When the instrument is initialized by the "RST" command in a User Program (ASP), the sweep mode is set to SINGLE.

2. Parameters Coupled to the Measurement Configurations

This paragraph describes the initial setting of the parameters which are measurement configuration dependent. When the instrument is turned on, or the CLEAR statement (device clear) is entered, the settings for all measurement configurations are initialized. But when the **PRESET** key is pressed (the "RST" command is entered), the setting for the current measurement configuration is initialized (ex. when the **PRESET** key is pressed during a S11 measurement, the setting for the Network, Impedance, Spectrum, S12, S21, and S22 measurement are not initialized).

(1) NETWORK measurement

Parameter	Initial Setting
Measurement Format	T/R[dB]- θ
Input Port	T1/R1
AUTO (Coupled to Span) on/off	off
Resolution Bandwidth (RBW)	10 kHz
Correction mode on/off	off
Calibration mode	none
IF Range	normal
Display Format	X-A&B
Trace A on/off	on
Trace B on/off	on
Scale Type lin/log	lin
Reference Value for data A	0 dB
Division Value for data A	10 dB
Bottom Value for data A	-100 dB
Reference Value for data B	180 deg
Division Value for data B	36 deg
Bottom Value for data B	-180 deg

(2) SPECTRUM measurement

Parameter	Initial Setting
Measurement Format	dBm
Input Port	R1
AUTO (Coupled to Span) on/off	on
Resolution Bandwidth (RBW)	300 kHz
Source off/CH1/CH2	off
IF Range	normal
Display Format	X-A&B
Trace A on/off	on
Trace B on/off	off
Scale Type lin/log	lin
Reference Value for data A	-10 dBm
Division Value for data A	10 dB
Bottom Value for data A	-110 dBm
Reference Value for data B	-10 dBm
Division Value for data B	10 dB
Bottom Value for data B	-110 dBm

(3) IMPEDANCE measurement

Parameter	Initial Setting
Measurement Format	$ Z -\theta$
Input Port	T1/R1
AUTO (Coupled to Span) on/off	off
Resolution Bandwidth (RBW)	3 kHz
Compensation Mode on/off	off
Correction Mode on/off	off
Calibration Mode	none
IF Range	High Sensitivity
Display Format	X-A&B
Trace A on/off	on
Trace B on/off	on
Scale Type lin/log	lin
Reference Value for data A	1 M Ω
Division Value for data A	100 k Ω
Bottom Value for data A	0 Ω
Reference Value for data B	180 deg
Division Value for data B	36 deg
Bottom Value for data B	-180 deg

(4) S-Parameter measurement (S11, S12, S21, and S22)

Parameter	Initial Setting
Measurement Format	RL- θ (S11 or S22) T/R(dB)- θ (S12 or S21)
Input Port	T1/R1 (S11) T1/R2 (S12) T2/R1 (S21) T2/R2 (S22)
AUTO (Coupled to Span) on/off	off
Resolution Bandwidth (RBW)	10 kHz
Correction Mode on/off	off
Calibration Mode	none
IF Range	normal
Display Format	X-A&B
Trace A on/off	on
Trace B on/off	on
Scale Type lin/log	lin
Reference Value for data A	0 dB
Division Value for data A	10 dB
Bottom Value for data A	-100 dB
Reference Value for data B	180 deg
Division Value for data B	36 deg
Bottom Value for data B	-180 deg

4-14-2. DEFAULT VALUE OF SINGLE VARIABLE REGISTERS

When the instrument is turned on, all single variable registers are cleared (set to zero). Only the registers which are set to a specific default value are introduced here.

During initialization using the **CLEAR** statement or the "RST" command, no single variable registers are cleared (data is not changed), but the following registers are set to a default value.

1. Single Variable Registers Coupled to the Sweep Mode

The START, STOP, STEP, CENTER, SPAN, and NOP register which are coupled to the sweep mode (sweep parameter), have the following default values.

Register	Sweep Mode				
	Frequency[Hz]	DC bias[V]	OSC [V]	OSC [dBm]	OSC [dBμV]
START	0.001 Hz	0.000 V	0.010 V	-26.000 dBm	81.000 dBμV
STOP	500000000.000 Hz	0.000 V	0.110 V	0.000 dBm	107.000 dBμV
STEP	1250000.000 Hz	0.100 V	0.001 V	0.200 dBm	0.200 dBμV
CENTER	250000000.000 Hz	0.000 V	0.060 V	-13.000 dBm	94.000 dBμV
SPAN	499999999.999 Hz	0.000 V	0.100 V	26.000 dBm	26.000 dBμV
NOP	401	101	101	131	131

2. Single Variable Registers for General Use

Register	Default Value
FREQ	10000000.000 Hz
OSC1	0.0 dBm
OSC2	0.0 dBm
BIAS	0.00 V
DFREQ	0.50 %
PER1	0.000 cm
PER2	0.000 cm
PET1	0.000 cm
PET2	0.000 cm
PEP1	0.000 cm
PEP2	0.000 cm
MANUAL	(CENTER)
PTSWP	1

Register	Default Value
ATR1	10 dB
ATR2	10 dB
ATT1	10 dB
ATT2	10 dB
MKR	(CENTER)
SMKR	(CENTER)
DMKR	0
LCURS	(REF+BTM)/2
DLCURS	0
EQVR	0
EQVL	0
EQVCA	0
EQVCB	0

4-14-3. DEFAULT VALUE OF ARRAY VARIABLE REGISTERS

When the 4195A is turned on, all array registers are cleared (set to zero), and only the **X** register is set to a default data.

During initialization by the **CLEAR** statement or the **PRESET** key, the array registers are not cleared, only the **X** register is initialized.

The default data of the **X** register depends on the value of the "START", "STOP", and "STEP" registers.

4-15. BATTERY BACK-UP MEMORY

The 4195A is equipped with a rechargeable battery which is used to provide standby power for the storage registers when the instrument is turned off. This paragraph describes the data stored in battery back-up memory, and the specifications of the battery backup function.

4-15-1. DATA STORED IN THE BATTERY BACK-UP MEMORY

The following parameters are always stored in the battery back-up memory.

1. User Math, User Defined Function, and Sweep End Function
2. HP-IB Address and Plot Scale
3. Standard Value for Calibration

When the 4195A is shipped, the parameters are set as follows.

1. User Math, User Defined Function, and Sweep End Function

The User Math, User Defined Function, and Sweep End Function are not defined, and are not labeled (no equation, no label, no parameter).

2. HP-IB Address and Plotter Scale

HP-IB Address: ADRS= 17

Plot Scale: PSCALE= 2000, 800, 9200, 7208

3. Standard Value for Calibration

Register	Network, S-Parameter		Impedance	
	Z=50Ω	Z=75Ω	Z=50Ω	Z=75Ω
OPNSTD	0.00S, 108fF	0.00S, 63.5fF	0.00S, 82fF	0.00S, 0.00pF
SHTSTD	0.00Ω, 0.00nH	0.00Ω, 0.00nH	0.00Ω, 0.00nH	0.00Ω, 0.00nH
LDSTD	50.00Ω, 0.00nH	75.00Ω, 0.00nH	50.00Ω, 0.00nH	75.00Ω, 0.00nH

'Z' indicates the characteristics impedance.

4-15-2. BATTERY BACKUP SPECIFICATIONS

The specifications of the rechargeable battery backup function are given below. The battery is automatically recharged while the instrument is on.

- Operating Time: Approximately 3 weeks (after a full charge)
- Recharge Time: Approximately 48 hours
(Time required to fully recharge the battery)
- Lifetime: Approximately 5 years (at 25 °C)

4-16. SYNCHRONIZING WITH OTHER INSTRUMENTS

The HP 4195A provides the reference signal input/output connectors which are used to synchronize with the external instruments.

4-16-1. EXTERNAL REFERENCE SIGNAL INPUT

The 4195A's internal reference signal can be synchronized to an external reference signal input through the rear panel **EXT REFERENCE** connector when the front panel **EXT REF** indicator is **on**. If the 4195A's internal reference signal cannot synchronize with the input reference signal, the **UNLOCK** indicator on the 4195A's front panel is turned **on**. The signal entered to the **EXT REFERENCE** connector must meet the following specifications.

Frequency:	10/N MHz, ± 10 ppm at $23 \pm 5^\circ\text{C}$ (N is integer from 1 to 10)
Level:	Typical 0 dBm ± 5 dBm
Input Impedance:	Approximately 50Ω

NOTE

In HP 4195As equipped with Option 001 (High Stability Frequency Reference) the **EXT REFERENCE** connector is connected to the **REFERENCE OVEN** connector which supplies the internal high stability reference signal.

4-16-2. REFERENCE SIGNAL OUTPUT

The **10 MHz OUTPUT** connector supplies a 10 MHz signal with which to phase-lock external instruments.

Frequency:	10 MHz, ± 20 ppm at $23 \pm 5^\circ\text{C}$
Output Level:	Typical 0 dBm
Output Impedance:	Approximately 50Ω

SECTION 5

EXTENDED CAPABILITIES

5-1. INTRODUCTION

This section contains information about the functions, capabilities, and operating procedures for the HP 4195A's powerful extended capabilities and functions.

NOTE

This section includes some of the 4195A's control commands. All control commands corresponding the softkey labels are shown in Appendix D. All of the 4195A commands can be seen in Appendixes E and F.

5-2. INTERNAL REGISTERS

The 4195A has internal registers, most of which are assigned to specific operations. The registers are categorized into three types -- array, multiple, and single type registers.

5-2-1. ARRAY REGISTERS

The array registers can have as many as 401 elements each. The elements in an array register are addressed by element number -- 1 through 401. Data at a specific array register element can be read from or written to by specifying element number (indexing into the array) as follows:

- | | |
|------------------------------|--|
| A(5) [ENTER/EXECUTE] | Displays the data at the fifth element of the Array Register A on the system message line. |
| B(5) = 3 [ENTER/EXECUTE] | Enters the value (3) into the fifth element of Array Register B. |

There are three kinds of Array Registers -- Display/Measurement Registers, General Purpose Registers, and Calibration Registers. All array registers are listed in Appendix F.

1) Display/Measurement Registers

The **A** and **B** registers are measurement data registers and are displayed on the CRT in bright yellow and intensified greenish-blue (cyan) traces, respectively. When the 4195A is performing a measurement (and the User Math function is turned off) data in registers A and B are updated automatically.

The **C** and **D** registers are superimpose data registers whose data can be displayed on the CRT in low intensity yellow and cyan traces, respectively.

The **MA** and **MB** registers are read only measurement data registers. These registers are used with the User Math function.

The sweep point measurement data is stored in the read only **X** register. The data in this register is automatically computed using the START, STOP, etc., parameters.

2) General Purpose Registers

The **E, F, G, H, I, J, RA, RB, RC, RD, RE,** and **RF** registers are general purpose registers. They are used for temporary storage of measurement data, calculation results, etc..

3) Calibration Data Registers

The calibration data registers have four letter names. The first letter of a register name -- **M** and **T** -- means **M**easured and **T**heoretical value (computed), respectively. The **M**easured registers are used to store the calibration measurement result data. The **T**heoretical registers are used to store a standards' computed OPEN, SHORT or LOAD calibration value.

The second letter of a register name -- **F** and **R** -- means **F**orward and **R**eversed, respectively. **F**orward registers are used to store the forward S-Parameter (**S11** and **S21**) calibration data. The **R**eversed registers are used to store the reversed S-Parameter (**S12** and **S22**) calibration data.

The third letter of a register name -- **O, S, L, T,** or **I** -- means **O**pen, **S**hort, **L**oad, **T**hrough, or **I**solation, respectively. The **O**pen registers are used to store the OPEN calibration data. The **S**hort registers are used to store the SHORT calibration data. The **L**oad registers are used to store the LOAD calibration data. The **T**hrough registers are used to store the THROUGH calibration data. The **I**solation registers are used to store the ISOLATION calibration data.

The last letter of a register name -- **R** and **I** -- mean **R**eal or **I**maginary, respectively. The **R**eal and **I**maginary registers are used to store the **R**eal and **I**maginary components of the calibration data.

3-1) S11 and Network-Reflection Calibration

The **MFOR**, **MFOI**, **MFSR**, **MFSI**, **MFLR**, **MFLI**, **TFOR**, **TFOI**, **TFSR**, **TFSI**, **TFLR**, and **TFLI** registers are for S11 and Network-Reflection calibration.

3-2) S21 and Network-Transmission Calibration

The **MFTR**, **MFTI**, **MFIR**, and **MFII** registers are for S21 and Network-Transmission calibration.

3-3) S12 Calibration

The **MRTR**, **MRTI**, **MRIR**, and **MRII** registers are for S12 calibration.

3-4) S22 and Impedance Calibration

The **MROR**, **MROI**, **MRSR**, **MRSI**, **MRLR**, **MRLI**, **TROR**, **TROI**, **TRSR**, **TRSI**, **TRLR**, and **TRLI** registers are for S22 and Impedance calibration.

3-5) Impedance Offset Compensation

The **ZOR**, **ZOX**, **ZSG**, and **ZSB** registers are for Impedance measurement offset compensation registers.

NOTE

The value range for the registers (except for the **X** register) is 0 and the values from $\pm 1\text{E-}37$ to $\pm 9.99999\text{E}+37$. The values range for the **X** register depends on the sweep parameter's set range.

Data in the array registers (except for the **X** register) is stored in the IEEE-32 bit (single precision) floating point notation format. Data in the **X** register is stored in the IEEE-64 bit (double precision) floating point notation format. For details about 4195A calibration, refer to the explanations given in Section 4.

5-2-2. MULTIPLE REGISTERS

The 4195A has four multi-value registers. The **LDSTD**, **OPNSTD**, and **SHTSTD** registers holds two values each, and the **PSCALE** register holds four values.

5-2-3. SINGLE REGISTERS

All single-value registers are listed in Appendix F. Some single-value registers are used to hold control commands parameters. For example, when setting the center frequency, you are entering desired center frequency value into the **CENTER** register.

5-3. MATH OPERATION

Tables 5-1 lists the 4195A math operators. These operators are used to perform calculations using constants and the values stored in the single registers, array registers, etc., as the arguments.

Table 5-1. Math Operators

Operator	Description
GENERAL	
+	Addition operator
-	Subtraction operator
*	Multiplication operator
/	Division operator
**	Exponentiation operator
ABS	Returns an expression's absolute value
EXP	Raises the base e to a specified power (natural antilogarithm)
LN	Returns the natural logarithm (base e) of an expression
LOG	Returns the common logarithm (base 10) of an expression
MAX	Returns the largest value of the two expressions
MIN	Returns the smallest value of the two expressions
PI	Returns an approximation of π (=3.1415.....)
SQR	Returns the square root of an expression
TRIGONOMETRIC	
ATAN	Returns the arc tangent of an expression
COS	Returns the cosine of an angle
DEG	Sets the degrees mode
RAD	Sets the radians mode
SIN	Returns the sine of an angle
TAN	Returns the tangent of an angle
BINARY	
BAND	Returns the bit-by-bit logical AND of two expressions
BOR	Returns the bit-by-bit logical inclusive OR of two expressions
BNOT	Returns the bit-by-bit logical COMPLEMENT of an expression
BIN	Returns an integer number (unsigned 8-bit) of an expression
OTHER	
DIF	Returns the logical differential calculus of the array register

5-3-1. GENERAL MATH OPERATORS

- + This function returns the sum of two expressions. This operation can be used for single value registers and array registers, and the expressions constructed with them. Examples follow.

$A = B + C$ The Sum of each **B** register element and each corresponding **C** register element are stored in the corresponding element of the **A** register. A single element register can be thought of as an array register with one element.

$A = B + 2$ Sum of each **B** register element and the constant 2 are stored in the corresponding elements of the **A** register.

$3 + 5$ Returns 8.

- This function returns the difference of two expressions. This operation can be used for single number and array registers, and expressions constructed of them. Examples are shown below.

$A = B - C$ The difference of each **B** and **C** register element are stored in the corresponding element of the **A** register.

$A = B - 2$ The difference of each **B** register element and the constant 2 are stored in the corresponding element of the **A** register.

$3 - 5$ Returns -2

- * This function returns the product of two expressions. This operation can be used for single number and array registers, and expressions constructed with them. Examples are shown below.

$A = B * C$ Product of each **B** and **C** register element are stored in the corresponding element of the **A** register.

$A = B * 2$ Product of each **B** register element and the constant 2 are stored in the corresponding element of the **A** register.

$3 * 5$ Returns 15

- / This function returns the quotient of two expressions. This operation can be used for single number and array registers, and expressions constructed with them. Examples are shown below.

$A = B / C$ The quotient of each **B** and **C** register element is stored in the corresponding element of the **A** register.

$A = B / 2$ The quotient of each **B** register element and the constant **2** is stored in the corresponding element of the **A** register.

$3 / 5$ Returns **0.6**

- ** This function returns the result of the exponentiation of two expressions. This operation can be used for single number and array registers, and expressions constructed with them. Examples are shown below.

$A = B ** C$ Each **B** register element raised to the power in each corresponding **C** register element is stored in the corresponding element of the **A** register.

$A = B ** 2$ Each **B** register element raised to the second power (**2**) is stored in the corresponding element of the **A** register.

$3 ** 5$ Returns **2.43 E+02**

NOTE

If **x** in the following syntax diagram is zero and **y** is negative, an error will occur. If **x** is negative, **y** will be always truncated to an integer number by the internal calculation routine.

xy**

- ABS** This function returns the absolute value of the expression in parentheses. The **ABS** function can be used for single number and array registers, and expressions constructed with them. Examples are shown below.

$A = ABS(B)$ The absolute values of each **B** register element is stored in the corresponding element of the **A** register.

$ABS(1-5)$ Returns **4**

EXP This function raises e to the power given by the expression. The 4195A, uses the value $e = 2.718\ 281\ 828\ 46$ as the base for the Natural (Naperian) logarithm. This operation can be used for single number and array registers, and expressions constructed of them. Examples are shown below.

$A = \text{EXP}(B)$ The base e logarithm value of each **B** register element is stored in corresponding element of the **A** register.

$\text{EXP}(2 + 3)$ Returns **1.484 131 591 03 E+02**

LN This function returns the natural logarithm (base e) of an expression. This operation can be used for single number and array registers, and expressions constructed with them. Examples are shown below.

$A = \text{LN}(B)$ The natural logarithm value of each **B** register element is stored in the corresponding element of the **A** register. If one or more **B** register elements are negative, an error will occur.

$\text{LN}(2 + 3)$ Returns **1.609 437 912 43**

LOG This function returns the common logarithm (base 10) of the expression. This operation can be used for single number and array registers, and expressions constructed with them. Examples are shown below.

$A = \text{LOG}(B)$ The common logarithm value for each **B** register element is stored in the corresponding element of the **A** register. If one or more **B** register elements are negative, an error will occur.

$\text{LOG}(2 + 3)$ Returns **6.989 700 043 36 E-01**

MAX This function returns the larger of two values. This operation can be used for single number and array registers, and expressions constructed with them. Examples are shown below.

$A = \text{MAX}(B, C)$ The larger of the values in each **B** and **C** register element location is stored in the corresponding element of the **A** register.

$\text{MAX}(-3, 2)$ Returns **2**

MIN This function returns the smaller of two values. This operation can be used for single number and array registers, and expressions constructed with them. Examples are shown below.

$A = \text{MIN}(B, C)$ The smaller of the values in each **B** and **C** register element location is stored in the corresponding element of the **A** register.

$\text{MIN}(-3, 2)$ Returns -3

PI This function returns 3.141 592 653 59, an approximate value for π .

$A = \text{PI}$ The value for π (3.14.....) is stored in all elements of the **A** register.

PI Returns **3.141 592 653 59**

SQR This function returns the square root of the expression. This operation can be used for single number and array registers, and expressions constructed with them. Examples are shown below.

$A = \text{SQR}(B)$ The square root of each **B** register element is stored in the corresponding element of the **A** register. If any of the **B** register elements are negative, an error will occur.

$\text{SQR}(2 + 3)$ Returns **2.236 067 977 50**

5-3-2. TRIGONOMETRIC OPERATORS

The trigonometric functions return a value based on the current angle mode setting (Radians or Degrees). Refer to paragraph 5-5, ANGLE MODE.

ATAN The arctangent function returns the value of an angle whose tangent is equal to the parameter of the function. Examples are shown below.

$A = \text{ATAN}(B)$ The Arctangent of each **B** register element is stored in the corresponding element of the **A** register.

$\text{ATAN}(2 + 3)$ Returns **7.869 006 752 60 E+01** (when in the degree mode).

COS The cosine function returns the cosine of its parameter. The range of the returned real value is -1 through +1. Examples are shown below.

$A = \text{COS}(B)$ The cosine of each **B** register element is stored in the corresponding element of the **A** register.

$\text{COS}(2 + 3)$ Returns **9.961 946 980 92 E-01** (When in the degree mode).

SIN The sine function returns the sine of its parameter. The range of the returned real value is -1 through +1. Examples are shown below.

$A = \text{SIN}(B)$ The sine of each **B** register element is stored in the corresponding element of the **A** register.

$\text{SIN}(2 + 3)$ Returns **8.715 574 274 77 E-02** (when in the degree mode).

TAN The tangent function returns the tangent of its parameter. Examples are shown below.

$A = \text{TAN}(B)$ The tangent of each **B** register element is stored in the corresponding element of the **A** register.

$\text{TAN}(2 + 3)$ Returns **8.748 866 352 59 E-02** (when in the degree mode).

5-3-3. BINARY OPERATORS

The 4195A binary operations internally will convert a floating-point number to an integer value (expressed as a signed 32-bit binary), only the lowest 8-bits (unsigned binary) of the resulting integer value are used. So only the values 0 through 255 are variable, the result of a binary operation always 0 through 255.

Binary operation can handle single values or expressions, but not arrays.

In this paragraph, a train of ones (1) and zeros (0) enclosed by a pair of square brackets ([and]) represent a binary value.

NOTE

Real values ranging from -2,147,483,648 to +2,147,483,647 can be used without error, because type real (floating-point) numbers are internally converted to signed-32-bit integer numbers, but the binary operation always results in a value within 0 to 255.

Binary operations are useful for handling **8-BIT INPUT/OUTPUT**.

BAND Returns the bit-by-bit logical **AND** of two expressions. Examples are shown below.

R0=3 BAND 5 1 [0000 0001], the bit-by-bit logical **AND** of 3 [0000 0011] and 5 [0000 0101] is stored in the R0 register.

15 BAND 85 Returns 5 [0000 0101] as a result of bit-by-bit logical **AND** of 15 [0000 1111] and 85 [0101 0101].

BOR Returns the bit-by-bit logical inclusive **OR** of two expressions. Examples are shown below.

R0 = 3 BOR 5 7 [0000 0111], the bit-by-bit logical inclusive **OR** of 3 [0000 0011] and 5 [0000 0101] is stored in the R0 register.

15 BOR 85 Returns 95 [0101 1111] as a result of bit-by-bit logical inclusive **OR** of 15 [0000 1111] and 85 [0101 0101].

BNOT Returns the bit-by-bit logical **COMPLEMENT** of two expressions. Examples are shown below.

R0 = BNOT (5) 250 [1111 1010], the bit-by-bit logical **COMPLEMENT** of 5 [0000 0101] is stored in the R0 register.

BNOT (85) Returns 170 [1010 1010] as a result of bit-by-bit logical **COMPLEMENT** of 85 [0101 0101].

BIN Performs two functions. 1) Converts an 8-bit train of ones and zeros to the corresponding integer number. 2) Converts the value in a real number register (**R0** through **R99**) to an unsigned 8-bit integer number. (Actually both results are converted to the IEEE 64-bit floating point format and stored in a type real register.) Examples are shown below.

$R0 = \text{BIN}(10101010)$ 170 [1010 1010] is stored in the **R0** register.

$R1 = 4000$, then;

$\text{BIN}(R1)$ Returns 160 [1010 0000], only the lowest 8-bits of 4000 [0000....0000 1111 1010 0000].

5-3-4. OTHER OPERATORS

DIF Returns the logical differential calculus value of an array register. This operation can be used only with array registers and expressions constructed from them. The differential calculus value is calculated as follows.

$$A(1) = (B(2) - B(1)) / (X(2) - X(1))$$

$$A(n) = (B(n + 1) - B(n - 1)) / (X(n + 1) - X(n - 1))$$

$$A(N) = (B(N) - B(N - 1)) / (X(N) - X(N - 1))$$

Where **A** is an array register in which the results of the preceding operation are stored. **B** is an array register whose values are operated upon. **X** is the 4195A's **X** register. **N** is the number of measurement (or display) points (NOP). **n** equals or is greater than 2 but equals or is less than **N-1**. An example is shown below.

$A = \text{DIF}(B)$ The logical differential calculus of the data in the **B** register is stored in the corresponding elements of **A** register.

5-3-5. MATH HIERARCHY

When a numeric expression contains more than one operation, an order of precedence is followed during their execution. Operations with the highest order of precedence are performed first. Multiple operations with the same order of precedence are performed in order from left to right. Table 5-2 shows the hierarchy for numeric operations.

Table 5-2. Math Hierarchy

Precedence	Operator
Highest	Parentheses: (<i>may be used to force any order of operations</i>) Exponentiation: ** Multiplication and division: * / Addition and subtraction: + - BAND BOR Relation operators: = <> < > <= >= AND OR
Lowest	

NOTE

The relation operators (=, <>, <, >, <=, and >=), and the **AND** and **OR** operators can only be used only in a User Program (ASP). Refer to the explanation for User Programs in section 7 for details on the relation operators and **AND** and **OR** operators.

5-4. COMPLEX MATRIX OPERATION

The 4195A can perform complex matrix operations. Two numeric expressions enclosed by a pair of angular brackets (< and >) and separated by a comma (,) will be treated as a complex-number numeric expression. The expression before the comma is the real component of the complex number and the number after the comma is imaginary component of the complex number. The usable math operators for use with complex expressions are + (addition), - (subtraction), * (multiplication) and / (division). A complex matrix must be calculated using the following syntax.

$$\langle a, b \rangle = \langle c, d \rangle \{ +, -, *, \text{ or } / \} \langle e, f \rangle$$

The above equation, written in 4195A syntax, is equivalent to the following mathematical equation form:

$$a + jb = (c + jd) \{ +, -, \times, \text{ or } \div \} (e + jf)$$

Where j represents the imaginary number unit (= $\sqrt{-1}$).

Where **a** and **b** are the real and imaginary parts of the calculation result, respectively. **a** and **b** in the above equation must be a value in a 4195A register (except for the read-only registers). If an array register(s) is used for one or more of the values **c** through **f**, then **a** and **b** must be array registers. **c**, **d**, **e**, and **f** can be constants, single registers, array registers, or numeric expressions. Examples are shown below.

4195A Expression $\langle RA, RB \rangle = \langle A, B \rangle - \langle C, D \rangle$
 $\langle R0, R1 \rangle = \langle A(3), B(3) \rangle / \langle 5, \text{SQR}(7) \rangle$

Equivalent Equation $RA + jRB = (A + jB) - (C + jD)$
 $R0 + jR1 = (A(3) + jB(3)) \div (5 + j\sqrt{7})$

5-5. ANGLE MODE

The 4195A has two angle modes -- **degrees** and **radians**. The choice of angle mode affects **1)** The phase values displayed in the measurement results, and **2)** The resulting values displayed by trigonometric calculations. Initially the angle mode is set to degrees when the 4195A is turned on or initialized.

To select the angle mode using the front panel softkeys, perform one of the following key sequences.

1. Press the **DISPLAY** key, and press 'more 1/2' softkey. You will see the 'PHS UNIT deg rad' softkey label displayed.
2. Press the **MATH OPERATOR** key, and press 'MATH function' softkey. You will see the 'PHS UNIT deg rad' softkey label displayed.

The mode selected will change to green on the 'PHS UNIT deg rad' softkey label. Each time you press the softkey, the angle mode will toggle between **deg** and **rad**. The HP-IB control command to set the degree and radian mode is **DEG** and **RAD**, respectively.

5-6. KEYBOARD EXECUTION

The 4195A keyboard input line can be used as a one-line input calculator and it can be used to send control commands to the 4195A.

The one-line calculator mode is called the immediate execution mode of the 4195A. When using this capability, the calculation result is stored in the Z register and is displayed on the system message line in scientific notation consisting of a 12-digit signed mantissa and a 2-digit signed exponent: Sd.ddddddddESdd (S: +/-, E: exponent, d: digit, 0 to 9). Example calculations are shown below.

Step	Key Stroke	Display Data (=Z)
1.	2 * 3 [ENTER/EXECUTE]	6.00000000000E+00
2.	Z - 3 [ENTER/EXECUTE]	3.00000000000E+00
3.	S Q R (Z) [ENTER/EXECUTE]	1.73205080757E+00

To send 4195A commands, type in the command using front panel alphabetical keys and then press the **ENTER/EXECUTE** key.

5-7. SUFFIXES

The 4195A can handle numeric expressions with certain suffixes attached.

5-7-1. ENGINEERING NOTATION

The 4195A can recognize and display data in engineering notation which is listed in Table 5-3. For example, the expression **1.23U** on the 4195A input is equivalent to **1.23E-6**.

Table 5-3. Engineering Notation

SI Symbol	Prefix	Display Expression	Input Expression	Multiplied Factor
T	tera	T	N.A.	1 000 000 000 000 = 10 ¹²
G	giga	G	N.A.	1 000 000 000 = 10 ⁹
M	mega	M	M	1 000 000 = 10 ⁶
k	kilo	K	K	1 000 = 10 ³
m	milli	m	m	0.001 = 10 ⁻³
μ	micro	μ	U	0.000 001 = 10 ⁻⁶
n	nano	n	N	0.000 000 001 = 10 ⁻⁹
p	pico	p	P	0.000 000 000 001 = 10 ⁻¹²
f	femto	f	N.A.	0.000 000 000 000 001 = 10 ⁻¹⁵
a	atto	N.A.	N.A.	0.000 000 000 000 000 001 = 10 ⁻¹⁸

NOTE: M (mega), K (kilo), U (micro), N (nano), and P (pico), the characters must be input as upper-case letters only. Only m (milli) is lower-case. N.A. in the above table means Not Available.

5-7-2. ENGINEERING UNITS

The 4195A recognizes the following engineering units.

HZ (for Hz), **DBM** (for dBm), **DBUV** (for dB μ V), and **V** (for volts)

5-8. SPECIAL CHARACTERS

All upper case alphabetic characters, all numeric characters and some frequently used characters (such as !, <, >, etc.) can be typed in from the 4195A's front panel keys. Less used characters can be typed in using the 'SPECIAL chars' softkey. The special characters that can be typed in using softkeys are:

π (pi), Ω (ohm), & (and), % (percent), # (number), $\sqrt{\quad}$ (square root), k (kilo), m (milli), μ (micro), n (nano), p (pico), f (femto), $^{\circ}$ (degree), θ (theta), ϕ (phi), Γ (gamma), \leftarrow (left arrow), \rightarrow (right arrow)

NOTE

Special characters are for display only, they are not used in computation, such as using the % (percent) character to represent 10 to the -2 power, or $2 \times \pi$ (pi) to represent the ratio of the circumference of a circle to its diameter.

In order to type in special characters from the front panel using softkeys, perform the one of the following key sequences.

1. Press the **DISPLAY** key, and press the 'more 1/2' and 'SPECIAL chars' softkeys to display the special character softkeys.
2. Press the **DEFINE MATH** key, and press the 'LABEL entry' and 'SPECIAL chars' softkeys to display the special character softkeys.

Additionally when transmitting via HP-IB, lower-case alphabetic characters and the 4195A unique special characters can be used. Table 5-4 lists the 4195A unique character codes. All ASCII characters not listed in Table 5-4 can be used as normal ASCII characters.

Table 5-4. 4195A Special Characters

Special Character	Decimal	Binary
α (alpha)	1	0000 0001
β (beta)	2	0000 0010
ω (omega)	3	0000 0011
Ω (ohm)	15	0000 1111
(absolute value sign, left)	16	0001 0000
(absolute value sign, right)	17	0001 0001
← (left arrow)	19	0001 0011
→ (right arrow)	21	0001 0101
√ (square root)	22	0001 0110
π (pi)	23	0001 0111
Δ (delta)	24	0001 1000
μ (micro)	25	0001 1001
° (degree)	26	0001 1010
ϕ (phi)	28	0001 1100
Γ (gamma)	29	0001 1101
θ (theta)	30	0001 1110
© (copyright)	31	0001 1111
τ (tau)	126	0111 1110
○ (circle marker)	127	0111 1111

The special characters can be used for the following purposes.

- Displaying a comment at the top of CRT screen. (**CMT**)
- Displaying a character string on the system message line. (**DISP**)
- Labeling for User Math Parameter. (**PRMA** and **PRMB**)
- Labeling for User Math Units. (**UNITA** and **UNITB**)
- Labeling for User Defined Functions. (**LBL1** to **LBL5** and **LBLA** to **LBLC**)
- Writing comments in a User Program. (Program line beginning with !)

5-9. USER MATH

The 4195A's Define-Math function gives you the power to define math functions with which to process measurement data and then display the results as your own defined measurement parameters. The softkeys used for the User Defined Math function are displayed when the **DEFINE MATH** key is pressed.

5-9-1. DEFINE CALCULATION

The '**DEFINE MATH A(B)**' softkey is used to define math functions. This softkey is displayed in the softkey area after the **DEFINE MATH** key is pressed, and the following command is displayed on the keyboard input line.

DMA= (or **DMB=**)

The variable indicates measurement data A or B using register MA or MB, respectively. The following commands illustrate how Math formulas are entered.

DMA= MA-10
DMB= MAX(MB,B)

NOTE

Additional softkeys are available for math function entry ('**' and 'DIF' cannot be used) when the **MATH OPERATOR** key is pressed. Refer to paragraph 5-3, MATH OPERATION for more information about math operators.

5-9-2. ENTERING THE PARAMETER AND UNIT LABELS

Use the '**A(B) PRMTR LBL**' and '**A(B) UNIT LBL**' softkeys to enter the parameter and unit labels, respectively. These softkeys are displayed in the softkey area by pressing the '**LABEL entry**' softkey.

1. Entering the Parameter Label

When the '**A(B) PRMTR LBL**' softkey is pressed, the following command is displayed.

PRMA" " (or **PRMB" ")**

The parameter label is entered by entering the characters for parameter name (3 characters max.) between double-quotation (") marks, as follows.

PRMA"XYZ"
PRMA"ABC"

2. Entry the Unit Label

When the 'A(B) UNIT LBL' softkey is pressed, the following command is displayed.

UNITA" " (or UNITB" ")

The unit for the defined parameter is entered by entering the characters for the unit (max. 7 characters) between double-quotation (") marks, as follows.

UNITA" mΩ "
UNITB" DBM "

NOTE

The softkeys displayed when the 'SPECIAL chars' softkey is pressed can be used for entering labels.

5-9-3. HOW TO ACTIVATE THE DEFINE MATH CAPABILITY

The 'MATH→A on off' and 'MATH→B on off' softkeys are used to select **DEFINE MATH A** and **B**, respectively. When these softkeys are set to 'on', the 4195A displays the computed data.

NOTE

To use the DEFINE MATH A or B function from a USER DEFINED FUNCTION, USER PROGRAM (ASP), or via HP-IB, use the "MATHA1" or "MATHB1" commands, respectively, and to erase them, use the "MATHA0" or "MATHB0" commands.

NOTE

The entered parameter name, unit, and equation are stored in battery back-up memory, and they can be stored to the Flexible Disc, as a part of the **Instrument State**.

5-9-4. EXAMPLE

In this example the **USER MATH A** function is used to retain the max value of every point for each succeeding sweep.

1. To define the max hold function, press the **DEFINE MATH** key, '**DEFINE MATH A**' softkey, **MATH OPERATOR** key, '**MATH FUNCTION**' softkey, '**more 1/4**' softkey, '**more 2/4**' softkey, '**MAX(,)**' softkey, blue key, **M, A, →** key, **INS CHAR** key, **A** and **ENTER/EXECUTE** key.
2. To label 'MAX' as the parameter name, press the **DEFINE MATH** key, '**LABEL entry**' softkey, '**A PRMTR LBL**' softkey, **M, A, green key, X, green key, "** (double quotation marks), and **ENTER/EXECUTE** key.
3. To label 'DB' as the unit, press the '**A UNIT LBL**' softkey, blue key, **D, B, green key, "** (double quotation marks), and **ENTER/EXECUTE** key.
4. To set the **DEFINE MATH** capability, press the '**return**' softkey (or **DEFINE MATH** key), and set the '**MATH→A on off**' softkey to 'on'.

NOTE

A User Math function can be defined in a **USER PROGRAM (ASP)**, **USER DEFINED FUNCTION**, or via **HP-IB**. The following commands give the same results as the above procedure.

1. **DMA= MAX(MA,A)**
2. **PRMA"MAX"**
3. **UNITA"DB"**
4. **MTHA1**

5-10. PARTIAL SWEEP

Use the 4195A's PARTIAL SWEEP capability when you want to measure only a selected part of the displayed sweep range. For example you have performed a full sweep and you want make an adjustment to minimize one of the harmonics, the partial sweep time in this case will be very short, so the response to adjustment is much better than if you tried to make the same adjustment using the full sweep range. To use partial sweep, press the **MENU** key, and the '**PARTIAL SWEEP**' softkey.

NOTE

When the '**PARTIAL SWEEP**' softkey is pressed, the MARKER/L CURSOR mode is set to the "o & * MKRS" mode, however you can change to any other MARKER/L CURSOR mode after you define the partial sweep range.

5-10-1. STORING THE PARTIAL SWEEP RANGE

Move the o marker and * marker to specify the partial sweep range, and then press the '**STORE SWP RNG**' softkey.

5-10-2. ACTIVATE PARTIAL SWEEP

To activate partial sweep, set the '**PART SWP on off**' softkey to 'on'. Two "Δ" marks will be displayed under the gradicule on the screen to indicate the partial sweep range, as shown in Figure 5-1. Then the succeeding sweep measurement is performed only within the range given by the two Δ marks.

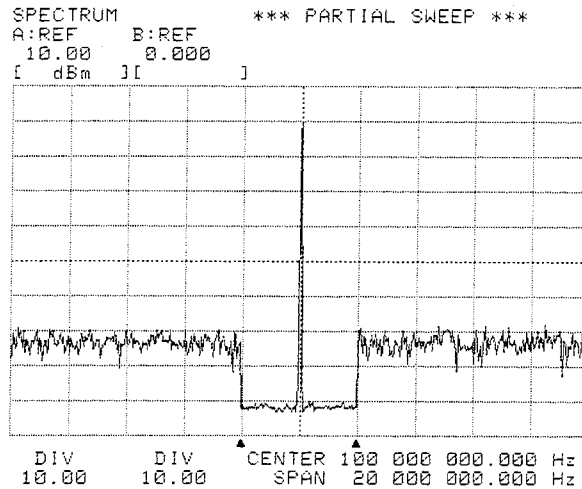

Figure 5-1. Partial Sweep Range

NOTE

To activate partial sweep from an USER DEFINED FUNCTION, USER PROGRAM (ASP), or via HP-IB, enter the following commands. The MARKER/L CURSOR mode must be set to the "o & * MKRS" mode, before the commands are entered.

- ex) **MKR= 10 MHZ** (move the o marker to 10 MHz position)
- SMKR= 100 MHZ** (move the * marker to 100 MHz position)
- SRSTR** (store the partial sweep range)
- SWR1** (set the partial sweep capability on)

5-11. PARTIAL ANALYSIS

PARTIAL ANALYSIS lets you analyze a selected portion of the displayed sweep range. When partial analysis is used, all of the 4195A's analysis functions can be used within the selected partial analysis range. To use partial analysis, press the **MORE** key, and the 'ANA RNG' softkey.

NOTE

When the 'ANA RNG' softkey is pressed, the MARKER/L CURSOR mode is set to the "o & * MKRS" mode, however you can change to any other MARKER/L CURSOR mode after you define the partial analysis range.

5-11-1. STORING THE PARTIAL ANALYSIS RANGE

Move the o marker and * marker to specify the partial analysis range, and press the 'STORE ANA RNG' softkey.

5-11-2. SELECTING PARTIAL ANALYSIS

To select partial analysis, set the 'PART ANA on off' softkey to 'on'. Then two "Δ" marks to indicate the partial analysis range, are displayed under the graticule on the screen, as shown in Figure 5-2. Then the succeeding analysis is performed only within the range given by the two Δ marks.

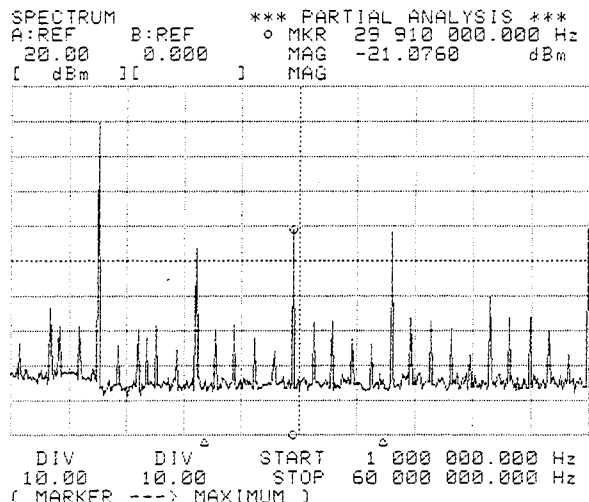

Figure 5-2. Partial Analysis Range

NOTE

When the partial analysis capability has been set, if the commands to store the measured data to the register are entered as follows, only the data in the partial analysis range is stored.

ex) **C=A**
D=B

NOTE

To set the partial analysis capability at the USER DEFINED FUNCTION, USER PROGRAM (ASP), or via HP-IB, enter the commands as shown in the following. The MARKER/L CURSOR mode must be set to the "o & * MKRS" mode, before the commands are entered.

ex) **MKR= 10 MHZ** (move the o marker to 10 MHz position)
SMKR= 100 MHZ (move the * marker to 100 MHz position)
ARSTR (store the partial analysis range)
ANA1 (set the partial analysis capability on)

5-12. PROGRAMMED POINTS MEASUREMENT

The Programmed Points Tables are used to measure the desired sweep points. So the Programmed Points Table is useful for analyzing particular regions with better sweep resolution around the point of interest.

5-12-1. PROGRAMMED POINTS TABLE

The 4195A has the four programmed points tables. Each table must include at least 2 sweep points, and can have the data for 101 points, respectively. If you make only 1 table, you can have up to 401 points (the maximum number of measurement points). If you try to enter sweep data at the 402nd point, the message "Number of points full" will be displayed. When a table contains data for 401 points, the other three tables are unavailable (the message "Memory full (all boxes used)" will be displayed).

NOTE

When the three tables are set with less than 102 points, if you try to enter the sweep data at the 102nd point in the fourth table, the message "Memory full (all boxes used)" is displayed.

5-12-2. SET THE PROGRAMMED POINTS TABLE

To display the softkey menu to set the Programmed Points Table, press the **MENU** key, and 'PROGRAM sweep' softkey, in sequence. The softkey tree is shown in APPENDIX D, Softkey Menu.

1. Select the Programmed Points Sweep Measurement

The 'PROG SWP on off' softkey is used to select the programmed points sweep measurement. When 'on' of this softkey label is green, the programmed points sweep measurement is available and the normal sweep measurement is not available. The "PPM1 (or PPM0)" command is used to set the programmed points sweep measurement 'on' (or 'off'), by the USER DEFINED FUNCTION, USER PROGRAM (ASP), or via HP-IB.

2. Select the Table Number

The 'TABLE No.' softkey is used to select table one to four. To select the table, press this softkey repeatedly until the correct table number is displayed. The "PTN=" command is used to set the table number, in place of this softkey. For example, if you want to select table number 4, use the "PTN=4" command.

NOTE

The "PTN=" command is available not only in the mode used to set the Programmed Points Table, but it is also available in other modes as well. So you can select the programmed points table without entering the table set mode.

3. Enter/Exit the Programmed Points Table Set Mode

The **'PROG TBL set up'** softkey is used to enter the mode to set up the programmed points table. This softkey corresponds to the **"PTSET"** command.

The **'set end'** softkey is used to exit the Programmed Points Table Set Mode. This softkey corresponds to the **"PTEND"** command.

4. Create/Modify a Programmed Points Table

The **'SWP select'** softkey is used to select the sweep parameters: Frequency (Hz), DC Bias (V), and OSC Level (V), (dBm), (dB μ V). To select the required sweep parameter, press this softkey repeatedly until the parameter you want to select is displayed. The default setting is frequency sweep.

To set the sweep parameter using the USER DEFINED FUNCTION, USER PROGRAM or via HP-IB, use the following commands.

PARAMETER	COMMAND
Frequency (Hz)	PTSWP1
DC Bias (V)	PTSWP2
OSC Level (V)	PTSWP3
OSC Level (dBm)	PTSWP4
OSC Level (dB μ V)	PTSWP5

The **'X REG dump'** softkey is used to set the sweep data in register X as the data for the programmed points table. This softkey corresponds to the **"XDMP"** command.

The **'SORTING'** softkey is used to SORT the order of the sweep parameter values entered into the Programmed Points Table. This softkey corresponds to the **"PTSRT"** command.

The **'TABLE ALL CLR'** softkey is used to clear the displayed table. This softkey corresponds to the **"PTCLR"** command. When pressing **'TABLE ALL CLR'** softkey, **"PTCLR"** is displayed on the keyboard input line, the table is cleared by pressing the **ENTER/EXECUTE** in sequence.

1. Press the **MENU** key in the SWEEP area.
2. Press the '**PROGRAM sweep**' softkey.
3. 1) If you want to select the frequency sweep mode, and have the RBW value to be coupled to the sweep points automatically entered, set the **AUTO** key to **on**.
2) If you select the DC bias or OSC level sweep mode, set the spot frequency.
4. Press the '**PROG TBL set up**' softkey to enter to the Programmed Points Table edit mode.
5. Press the '**TABLE No.**' softkey repeatedly until the desired table number is displayed on the screen.
6. Press the '**TABLE ALL CLR**' softkey and the **ENTER/EXECUTE** key, if you need to clear the table.
7. Press the '**SWP select**' softkey repeatedly until the parameter you want to select is displayed on the screen.

NOTE

To change the sweep mode, the table must be empty. The message, "Can't change while data exist" will alert you by beeping when this softkey is invalid.

8. Enter the sweep points (data) using the following procedure.

FOR FREQUENCY SWEEP MEASUREMENT

- 1) Enter the sweep point (data).
- 2) Press the **right arrow** key (→), to move the cursor to the RBW area, and enter the RBW value.

NOTE

When the **AUTO** key is set to **on**, if you want to set the value of RBW to be coupled to the sweep points, omit sequence 2. If you omit the sequence 2 when the **AUTO** key is set to **off**, RBW is set to 300 kHz.

- 3) Press the **ENTER/EXECUTE** key.
- 4) Repeat until all sweep points are entered.

FOR DC BIAS OR OSC LEVEL SWEEP MEASUREMENT

- 1) Enter the sweep point (data), and press the **ENTER/EXECUTE** key.
- 2) Repeat sequence 1, until all sweep points are entered.

NOTE

If you use the RBW value displayed on screen, omit steps 3 and 4. This RBW value is the spot frequencies coupled value.

- 3) Press the **right arrow** key (→) to move the cursor to the RBW area, and press the **CLR LINE** key.
- 4) Enter the value for RBW, and press the **ENTER/EXECUTE** key.
8. Press the **'SORTING'** softkey, if you need to sort the order of the sweep points.
9. Press the **'set end'** softkey.

5-12-4. PROGRAMMED POINTS MEASUREMENT PROCEDURE

1. Press the **MENU** key in the SWEEP area.
2. Press the **'PROGRAM sweep'** softkey.
3. Press the **'PROG TBL set up'** softkey.
4. Press the **'TABLE No.'** softkey repeatedly until the correct table number is displayed.
5. Press the **'set end'** softkey.

NOTE

The "PTN=" command can be used in place of steps 3, 4, and 5.

6. Press the **'PROG SWP on off'** softkey.
7. Press the **TRIG/RESET** key.

NOTE

The data in the programmable points table is erased when the instrument is turned off, but the data can be saved to the flexible disc. Refer to paragraph 5-18, MASS STORAGE.

5-12-5. HOW TO PRINT THE PROGRAMMED POINTS TABLE

You can make a print out of the Programmed Points Table by using the procedure described in paragraph 5-13-5, Copy Procedure. Use the following steps.

- (1) Display the Programmed Points Table to be printed.
- (2) Exit the Programmed Points Table edit mode.
- (3) Perform the Copy Procedure in paragraph 5-13-5, and then select the PRINT mode.

NOTE

If the Programmed Points Table to be printed is stored on the floppy disc, load the Programmed Points Table first. The loading procedure is described in paragraph 5-18.

5-13. HARD COPY

The 4195A provides the hard copy capability for making a hard copy of the information displayed on the screen by using a plotter or printer via an HP-IB, without a controller.

5-13-1. COPYING CAPABILITIES

The 4195A has three copy modes: **PLOT**, **PRINT**, **DUMP**. In the PLOT mode, a plotter must be connected to the 4195A, and in the PRINT and DUMP modes, a printer must be connected. Table 5-5 shows the copy capabilities of these three modes.

- (1) **PLOT mode** Plot the information displayed on the 4195A's screen.
- (2) **PRINT mode** Print the data (in the register A, B, and X) as the numerical tabular form data. In the PROGRAMMED POINTS Table, ASP LIST and DISK CATALOG pages, the all programmed points data, the all program lines, and a list of all stored programs are printed, respectively.
- (3) **DUMP mode** Dump the screen to a raster graphics printer.

Table 5-5. Capabilities of Three Copy Modes

CRT page	PLOT mode	PRINT mode	DUMP mode
RECTANGULAR X-A&B	YES	YES	YES
RECTANGULAR A-B	YES	YES	YES
TABLE	NO	YES	YES
SMITH	YES	YES	YES
POLAR	YES	YES	YES
PROGRAMMED POINTS TABLE	NO	YES	YES
EQUIVALENT CIRCUIT PAGE	NO	NO	YES
ASP LIST	NO	YES	YES
DISC CATALOG	NO	YES	YES

YES: Available

NO: Not available. An error message "Plot allowed X-A&B/A-B/SMITH/POLAR" or "Can't print data on this display" will be displayed on the System Message Line.

5-13-2. HOW TO MAKE A HARD COPY

The following three methods can be used to make a copy of the measurement data.

1. Manually using the 4195A's front panel keys.
2. Using a User Program.
3. Using an HP-IB controller.

In method No. 1, the plotter or printer must be interconnected to the 4195A via HP-IB. The 4195A must be set to the Talk-only mode, and the plotter or printer must be set to the Listen-only mode. The procedure for making a copy of the 4195A's display is described in paragraph 5-13-5.

In method No. 2, the connected listen-only device and a User Program are required to make a copy of the display. You can use the 'TALK only' softkey or the "HADM2" command to set the 4195A to the Talk-Only. Refer to paragraph 6-4, User Program, for User Program details.

NOTE

The commands used to copy, are listed in the APPENDIX D, Softkey Tree.

In method No. 3, the HP-IB controller, plotter or printer, and a program to control the peripherals are required to copy the display. Then the 4195A must be set to the Addressable mode, using the 'ADDRESSABLE' softkey (the plotter or printer must be addressable). Refer to the paragraph 6-5-8, Example 3, Hard Copy.

NOTE

By using the following query commands, it is possible to print the characters on the Comment Area or the System Message Line, and the data in the register. The details of the query commands, are described in paragraph 6-5-4.

DISP? (output the characters on the System Message Line)
CMT? (output the characters on the Comment Area)
(register)? (output the data in register: **MKR?**, **R0?** and etc.)

5-13-3. RECOMMENDED PLOTTERS AND PRINTER

Table 5-6 lists the recommended Plotters and Printer.

Table 5-6. Recommended Plotters and Printers

Plotter	HP 7440A with HP 17440A (PLOT mode only) 8 colors HP 7475A (PLOT mode only) 6 colors HP 7550A (PLOT mode only) 8 colors
Printer	HP 2225A (PRINT and DUMP mode only)

5-13-4. PLOT MODE

The plot type, plotting position and size can be set in the PLOT Mode. To display the plot menu, press the 'PLOT menu' softkey.

1. Plot Type Selection

The information sent to the plotter can be selected by using the 'ALL', 'GRTCL & DATA', or 'DATA only' softkeys, as follows.

- ALL** Plot all displayed information except for the information in the Soft-key Area.
- GRTCL & DATA** Plot the information displayed inside the screen graticule, including the graticule.
- DATA only** Plot only the data traced in the graticule without the graticule.

2. Setting the Plotting Position and Size

The plotting position and size can be set using the 'PLOT AREA' softkey.

The plot area (the data sent to the plotter is drawn in the plot area) is defined by P1 and P2, as shown in Figure 5-3. Press 'PLOT AREA' softkey, the **PSCALE** command will be displayed as follows.

PSCALE= P1x, P1y, P2x, P2y

P1x, P1y, P2x, and **P2y** are defined as shown in Figure 5-3. In the PSCALE command, if no values are entered, the default values of 2000, 800, 9200, and 7208 are displayed for **P1x, P1y, P2x** and **P2y**, respectively.

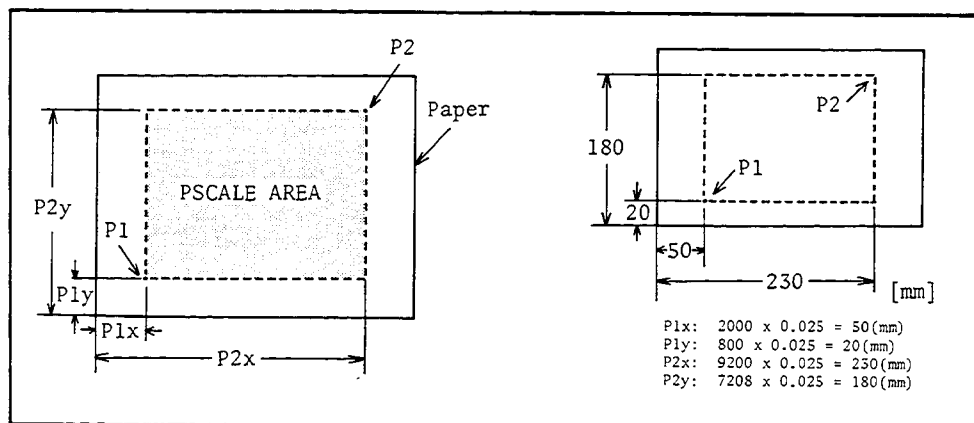

Figure 5-3. Plot Area

To set the plot area, press the 'PLOT AREA' softkey, the **ENTRY** area number keys to enter the P1, P2 values, and press the **ENTER/EXECUTE** key. A plotter unit equals 0.025 mm (ie. 40 plotter units equal 1 mm).

The P1 and P2 values are sent to the plotter by pressing the '**SEND P1, P2**' softkey. Before pressing this softkey, the 4195A must be set to the Talk-only mode, and the plotter must be set to the Listen-only.

When an HP-IB controller is used, the BASIC statements to set the 4195A as a talker, and the plotter as a listener, and a **WAIT** statement must exist after the "**SENDPS**" command (the command corresponding to the '**SEND P1, P2**' softkey) on the program list. The wait time depends on the plotter being used. Refer to paragraph 6-5-8, Example 3, (1) Plot (CPYM1).

3. Plot Area Selection

The information to be drawn in the inside of plot area can be selected using the '**P1, P2 normal**' and '**P1, P2 GRTCL**' softkey. Figure 5-4 shows two examples of using the plot area.

P1, P2 normal The information between the function area and the keyboard input line screen is drawn in the plot area.

P1, P2 GRTCL The information inside of the graticule on the HP 4195A's screen is drawn in the plot area. If the plot type is set to "ALL", the information out of the graticule on the 4195A's screen is drawn on the outside of the plot area.

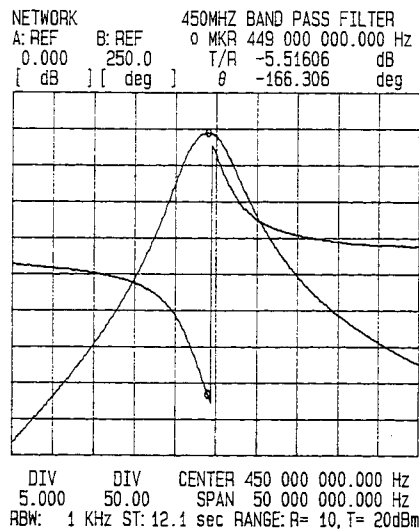

(1) P1, P2 GRTCL

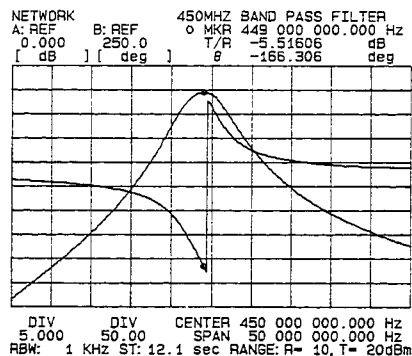

(2) P1, P2 normal

Figure 5-4. P1, P2 Normal and Graticule

NOTE

To draw the smith chart, or polar chart, the following equation must be satisfied.

$$P2x-P1x : P2y-P1y = 9 : 8.01 \quad (\text{at 'P1,P2 normal' })$$

5-13-5. COPY PROCEDURE

1. Connect the plotter or printer using an HP-IB cable, and set the plotter or printer to Listen-only.
2. Display the information to be copied on the screen.
3. Press the **COPY** key on the 4195A's front panel, the **COPY** menu will then be displayed in the Softkey Area of the screen.
4. Press the '**HP-IB define**' softkey, the HP-IB define menu will be displayed in the Softkey Area.
5. Press the '**TALK only**' softkey, to configure the 4195A for **TALK ONLY** mode. Then the softkey label will change to **green**.
6. Press '**return**' softkey or the **COPY** key, to return to the **COPY** menu.
7. Press the '**PLOT mode**', '**PRINT mode**', or '**DUMP mode**' softkey, to select the copy mode.
8. Press the '**COPY start**' softkey, then a printer or plotter will start copy. To abort a copy, press the '**COPY abort**' softkey.

NOTE

When the '**COPY start**' softkey is pressed, the sweep mode changes to the **SINGLE** mode, and the sweep stops.

NOTE

When using the HP-IB controller, set the 4195A's HP-IB definition to **ADDRESSABLE**. The details of the HP-IB definition are described in paragraph 6-5-2. The example using the Hard Copy capability is shown in paragraph 6-5-8, Example 3.

5-13-6. PLOT PEN SELECTION

Table 5-7 indicates the the relation of the pen number and the information on the 4195A's screen.

Table 5-7. Plot Pen Selection (1 of 2)

(1) Rectangular X-A&B

Pen Number	Description
1	Data A; A REF (label, data, unit); DIV or BTM of the data A (label, data); Data C (Superimpose; dotted line)
2	Data B; B REF (label, data, unit); DIV or BTM of the data B (label, data); Data D (Superimpose; dotted line)
3	Graticule; Sweep Range; RBW; ST (Sweep Time); RANGE (R, T); Function
4	Information in the marker area; o marker; * marker; line cursor; Analysis Range
5	Information in the comment area, and the keyboard input line
6	System Message

(2) Rectangular A-B

Pen Number	Description
1	REF, DIV, BTM for data A (label, data, unit)
2	REF, DIV, BTM for data B (label, data, unit)
3	Graticule; Sweep Range; RBW; ST; RNG (R, T); Function; <Horizontal>; <Vertical>
4	Information in the marker area; o marker; * marker
5	Information in the comment area, and the keyboard input line; Data A-B; Data C-D (Superimpose, dotted line)
6	System Message

Table 5-7. Plot Pen Selection (2 of 2)

(3) Smith Chart

Pen Number	Description
1	R (label, unit); X (label, unit)
2	Ls (label, unit); Cs (label, unit)
3	Graticule; Sweep Range; RBW; ST; RNG (R, T); Function
4	Information in the marker area; o marker; * marker; R, X, Ls, Cs (data)
5	Information in the comment area, and the keyboard input line; Data A-B; Data C-D (Superimpose, dotted line)
6	System Message

(4) Polar Chart

Pen Number	Description
1	RTN LOSS (label, unit), VSWR (label)
2	REF, DIV (label, data)
3	Graticule; Sweep Range; RBW; ST; RNG (R, T); Function
4	Information in the marker area; o marker; * marker; RTN LOSS (data); VSWR (data)
5	Information in the comment area, and the keyboard input line; Data A-B; Data C-D (Superimpose, dotted line)
6	System Message

5-14. EQUIVALENT CIRCUIT FUNCTION

The Equivalent Circuit function is used to calculate the equivalent circuit parameters of the measured impedance, and to simulate the frequency characteristics of the impedance. This capability is available at the Impedance measurement $|Z|-\theta$, $|Y|-\theta$. Frequency characteristic simulation also can be used for Impedance (R-X, G-B) S11, and S22 measurements.

5-14-1. HOW TO ENTER THE EQUIVALENT CIRCUIT ANALYSIS MODE

To enter the equivalent circuit analysis mode, press the **MORE** key, and 'EQV CKT' softkey, in the Impedance, S11, or S22 measurement configuration. In the Network, Spectrum, S12, or S21 measurement configuration, the Equivalent Circuit Function is unavailable.

5-14-2. HOW TO SELECT THE EQUIVALENT CIRCUIT MODEL

To use the Equivalent Circuit Function, the Equivalent Circuit Model must be selected first. Five Equivalent Circuit Models can be selected, as shown in Table 5-8.

To select the Equivalent Circuit Model, the 'CKT A', 'CKT B', 'CKT C', 'CKT D' and 'CKT E' softkeys are used.

NOTE

The Equivalent Circuit Function can be used by the User Program, or via HP-IB. The commands to use this function are listed in APPENDIX D, Softkey Tree.

Table 5-8. Equivalent Circuit Model Selection Guide

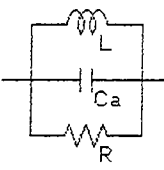
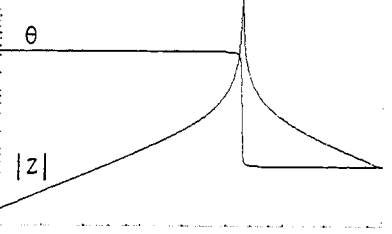
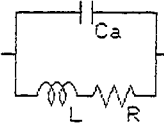
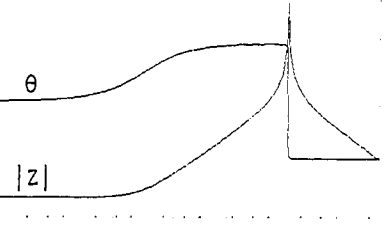
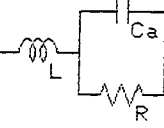
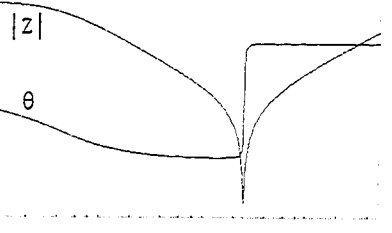
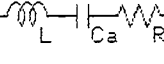
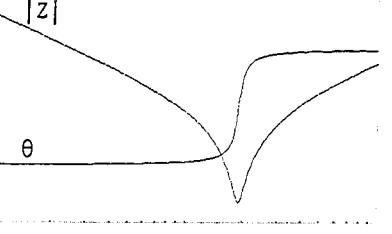
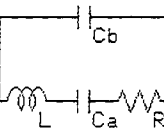
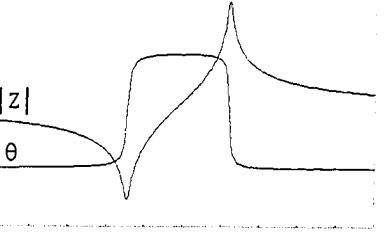
Equivalent Circuit	Types of DUTs	$ Z $ - θ characteristics
<p>A</p> 	<p>► Coils with high core loss</p>	
<p>B</p> 	<p>► Coils in general ► Resistors</p>	
<p>C</p> 	<p>► High-value resistors</p>	
<p>D</p> 	<p>► Capacitors</p>	
<p>E</p> 	<p>► Resonators (crystal, ceramic, ferrite)</p>	

5-14-3. HOW TO CALCULATE THE EQUIVALENT CIRCUIT PARAMETERS

The 4195A calculates the approximate value of each equivalent circuit parameter for which ever Equivalent Circuit mode is selected by the user. Before calculation, the measured data must be in the A and B registers. This function is available at the impedance ($|Z|-\theta$ or $|Y|-\theta$) measurement. The Equivalent Circuit is constructed by the Resistor, Inductor, and Capacitor, as shown in Table 5-8.

To calculate the equivalent circuit parameter, the '**CALC EQV para**' softkey is used. While the calculation is being performed, the message "Calculating EQV parameters" is displayed. After the calculation is completed, the value of the equivalent parameters are displayed, and entered to the registers, as follows.

Parameter	Register
Resistor (R)	EQVR
Inductor (L)	EQVL
Capacitor (Ca)	EQVCA
Capacitor (Cb)	EQVCB

5-14-4. HOW TO SIMULATE THE FREQUENCY CHARACTERISTICS

The frequency characteristics are simulated by using user entered values, or the data approximated by calculation described in paragraph 5-14-3. This function is mainly used to confirm that the equivalent circuit parameter approximations are close enough to the characteristics of the DUT. This function is available at for impedance ($|Z|-\theta$, $|Y|-\theta$, R-X or G-B), S11, and S22 measurement.

To simulate the frequency characteristics, the '**SIMULATE f char**' softkey is used. The simulation is performed for the measurement data A and B. While the calculation is being performed, the message "Calculating f characteristics" is displayed. When the simulation is completed, the simulated data is traced on the graticule with the measurement data A, and B. Here, the simulated data for data A is stored to the register C, and the simulated data for data B is stored to the register D.

NOTE

If important data is stored in registers C and D and you don't want the data destroyed, move the data into registers other than the C and D registers.

If you want to simulate the frequency characteristics by using the equivalent circuit parameters (R, L, Ca and Cb) you entered, enter the parameter's value you want by using the '**EQV R**', '**EQV L**', '**EQV CA**', and '**EQV CB**' softkeys, before performing the simulation. For example, to set the value for R to 50 Ω , press the '**EQV R**' softkey, 5, 0, and **ENTER/EXECUTE** key (or enter the "EQVR=50" command).

5-15. 8-BIT INPUT/OUTPUT

The 4195A provides an 8-bit Input/Output port for communicating with peripheral devices. Communication is through the rear-panel connector labeled "8-BIT INPUT/OUTPUT". Figure 5-5 shows the connector and its pin assignments. DI0 - DI7 and DO0 - DO7 are 8-bit parallel I/O ports, respectively. The EOS pin and EOM pin output the negative pulse at the end of sweep, and the end of measurement, respectively. The 8-bit Input/Output connector mates with a D-SUB connector series D25 (25-pin).

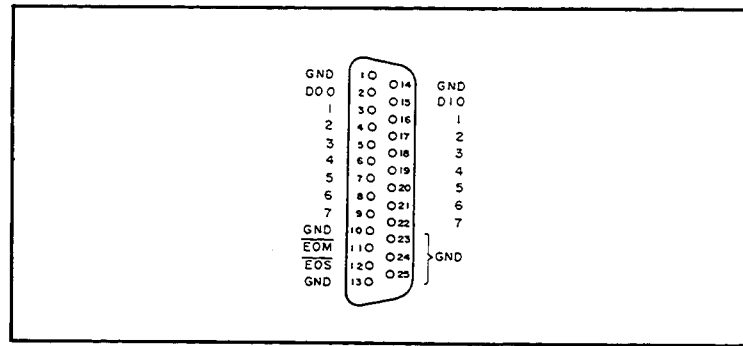

Figure 5-5. 8-bit I/O Connector

5-15-1. 8-BIT INPUT

Figure 5-6 shows the equivalent circuit for the internal circuit of the 8-bit Input port.

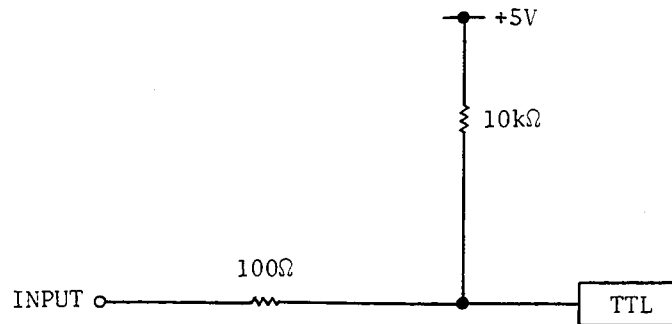

Figure 5-6. 8-bit Input Port Equivalent Circuit

To input the data from the peripheral, the "INPUT" command is used. The "INPUT" command is used as the following syntax:

INPUT Rn (n= 0 to 99)

For example, if you use INPUT R0 then the data on the input port will be stored into the register R0 as a decimal expression. On the input port DI7 is the MSB and DI0 is the LSB.

The following program is an example of the User Program which starts a sweep measurement when any pin of the input port is Low.

```
10 SWM2
20 INPUT R0
30 IF R0= 255 THEN 20
40 SWTRG
50
.
.
.
```

NOTE

1. In the no input condition, the data entered by the "INPUT" command, is 255 because of the pull-up resistor.
 2. The 8-bit Input Port detects the level (not the positive/negative going edge). So, the signal of the 8-bit Input Port must be stable, when the "INPUT" command is executed.
 3. The "INPUT" command can be entered by the User Program, User Defined Function, Sweep End Function, via HP-IB, and from the Keyboard Input Line.
 4. The binary-AND, and OR of the 8-bit input can be performed by using the "BAND" and "BOR" commands, respectively. The details are described in paragraph 5-3, MATH OPERATORS.
- ex) INPUT R1 (Enter the 8-bit data to R1)
INPUT R2 (Enter the 8-bit data to R2)
R0= R1 BAND R2 (Enter the binary-AND of R1 and R2 to R0)

5-15-2. 8-BIT OUTPUT

Figure 5-7 shows the equivalent circuit for the internal circuit of the 8-bit Output Port.

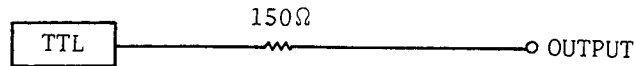

Figure 5-7. 8-bit Output Port Equivalent Circuit

To output data to a peripheral, the "OUTPUT" command is used. The "**OUTPUT**" command is used as the following syntax:

OUTPUT Rn (n= 0 to 99)
 or
OUTPUT BBBBBBBB (8-bit binary value starting from MSB= DO7)

When the "**OUTPUT Rn**" command is entered, the data in the register **Rn** is output. When the "**OUTPUT BBBBBBBB**" is entered, the binary data '**BBBBBBBB**' is output. Where, B= 0 is assigned to low level, and B= 1 is assigned to high level. DO7 is the MSB and DO0 is the LSB at Figure 5-5.

For example, to output the data '**00010001 (17)**' (DO7 to DO5= 0, DO4= 1, DO3 to DO1= 0, and DO0= 1), the following command is used.

R0=17
OUTPUT R0
 or
OUTPUT 00010001

NOTE

1. The initial setting is all bits of 8-bit Output Port are high.
2. The output level on 8-bit Output Port stays the same until a new "**OUTPUT**" command is entered. The data must be read before the next "**OUTPUT**" command is entered.
3. The "**OUTPUT**" command can be entered by the User Program, User Defined Function, Sweep End Function, via HP-IB, and from the Keyboard Input Line.

5-15-3. OUTPUT TIMING

The \overline{EOS} (End of Sweep) and \overline{EOM} (End of Measurement) signals are negative going, are about 350 ns long, and have no direct relationship to the I/O port. They can be used for auxiliary purposes. Figure 5-8 shows the output timing of the \overline{EOS} and \overline{EOM} signals.

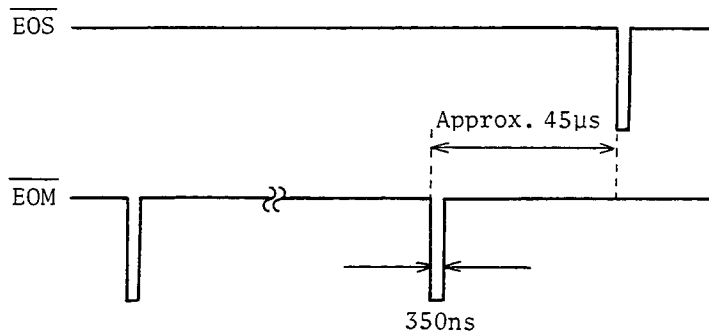

Figure 5-8. \overline{EOS} and \overline{EOM} Output Timing (Typical)

NOTE

The equivalent circuit of the \overline{EOS} and \overline{EOM} output port, is same as the equivalent circuit of 8-bit Output Port.

5-16. DISPLAY CHARACTERS/REGISTER DATA ON THE CRT

It is possible to display the characters or the data in the register on the screen, by using the "CMT" command ('COMMENT' softkey) or the "DISP" command. These commands can be used by the USER DEFINED FUNCTION, USER PROGRAM, and via HP-IB. And it is possible to enter these commands from the keyboard input line.

5-16-1. CMT command

The CMT command is used to display the characters (max. 26 characters) to the Comment Area. This command corresponds to the 'COMMENT' softkey which is included to the softkey menu in the DISPLAY key. This command is used in the following syntax.

CMT "ABCDEFGHIJKLMNOPQRSTUVWXYZ"

When this command is entered, the following comment is displayed on the comment area.

ABCDEFGHIJKLMNOPQRSTUVWXYZ

5-16-2. DISP command

The DISP command is used to display the characters or the data in the register **Rn** (n= 0 to 99) or both to the System Message Line. The number of the characters that can be displayed in the System Message Line is 44. This command corresponds to the 'DISP' softkey which is included to the softkey menu in the EDIT mode. But this softkey is usable only in the User Program (ASP) editor mode. This command is used to the following syntax.

DISP "XXXXX"

When this command is entered, the following comment is displayed on the system message line.

XXXXX

DISP Rn (n= 0 to 99)

When this command is entered, the value in the register Rn is displayed on the system message line, as follows.

0.00000000000E+00

DISP "XXXX=", Rn (n= 1 to 99)

When this command is entered, the comment and value of the register Rn is displayed, as follows.

XXXX= 0.00000000000E+00

5-17. USING ACTIVE PROBES

The 4195A provides two **PROBE POWER** jacks. The **PROBE POWER** jack locates on the front panel of the 4195A's MEASUREMENT UNIT, and supplies power to the active probes for the incircuit measurement of AC circuits. The voltage outputs are shown in Figure 5-9. The maximum current for the ' +15V ' pin is 300 mA, and the maximum current for the ' -12V ' pin is 160 mA. This values are total current of the two **PROBE POWER** jacks.

When the HP 41800A Active Probe is used with the 4195A, connect the power plug of the probe directly into the **PROBE POWER** jack.

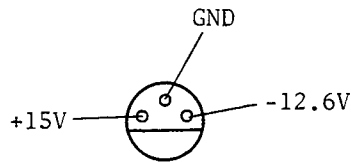

Figure 5-9. **PROBE POWER** Jack

5-18. MASS STORAGE

You can use the HP 4195A's built in 3-1/2 inch flexible disc drive (contained in the control unit) to save and retrieve the following four types of data.

1. Instrument Settings (STATE)
2. Program Point Table (PPT)
3. Register Data (DATA)
4. User Program (ASP)

5-18-1. SAVED INSTRUMENT SETTINGS

All of the 4194A's control settings and instrument state can be saved and retrieved except for the items listed after this paragraph. When the 4195A is used by more than one user or a single user uses more than one measurement setup the 4195A's setup state for each use can be quickly stored and recalled as needed.

Data in Display/Measurement Array Registers
 Data in General Purpose Array Registers
 Data in Single Registers that are derived from measured data
 Data in General Purpose Single Registers (R0 through R99)
 Measurement Point Data in the PROGRAM POINTS TABLE
 User Program lines on the work area

NOTE

When the correction or compensation mode is set to **ON**, only the currently active calibration data is saved with the instrument settings.

Some of the battery-backed instrument settings will change to reflect the retrieved settings.

If there is no Program Points Table stored in the 4195A, the Program Table Measurement will automatically be reset.

5-18-2. SAVING A PROGRAMMED POINT TABLE

The 4195A can save the 4195A's current programmed point table for later retrieval.

5-18-3. SAVING REGISTER DATA

The 4195A's register data in array registers A and B, and single registers R0 through R99 can be saved and retrieved.

5-18-4. SAVING USER PROGRAMS

User Programs (ASP) can be saved on the disc, one program per file.

5-18-5. BUILT-IN DISC DRIVE

Figure 5-10 shows the built-in disc drive front panel. The following is a brief description of the disc drive.

- (1) **DISC SLOT:** The slot where a 3-1/2 inch micro flexible disc is inserted.
- (2) **ACCESS LAMP:** The **ACCESS** lamp will be **ON** while the 4195A is storing or retrieving data to or from the disc.
- (3) **EJECT BUTTON:** Pressing this button ejects the inserted disc.

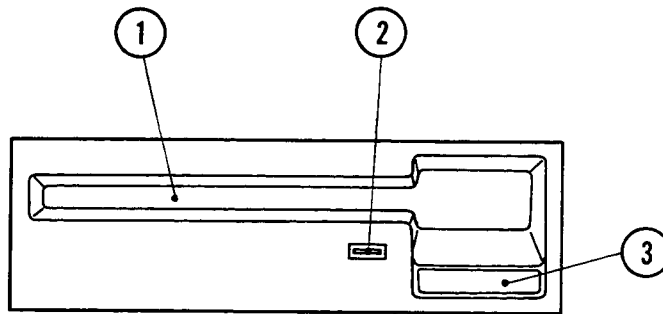

Figure 5-10. Built-in Disc Drive

5-18-6. USABLE DISCS

The 4195A uses double-sided, double-density 3-1/2 inch flexible disc. These discs can be ordered using HP 92192A (a box of 10 Micro Flexible discs).

NOTE

Disc drive performance and reliability are dependent on the type of media used. Disc drive specifications can be assured only when using HP media. The use of improper media can result in premature disc failure or damage to the disc drive.

Hewlett-Packard double sided discs are gray and are labeled "double-sided."
Hewlett-Packard single sided discs are blue and are labeled "single-sided."

5-18-7. WHAT IS A FLEXIBLE DISC?

The flexible disc is made from a flexible polyester sheet coated with a thin layer of magnetic oxide. This polyester sheet is enclosed in a protective plastic jacket designed to keep the recording surface clean. The plastic jacket also helps keep the disc flat when the disc is rotating in the drive.

5-18-8. A LOOK AT A FLEXIBLE DISC

Figure 5-11 illustrates the parts of a flexible disc. As you read the following description, please note the described features on your disc.

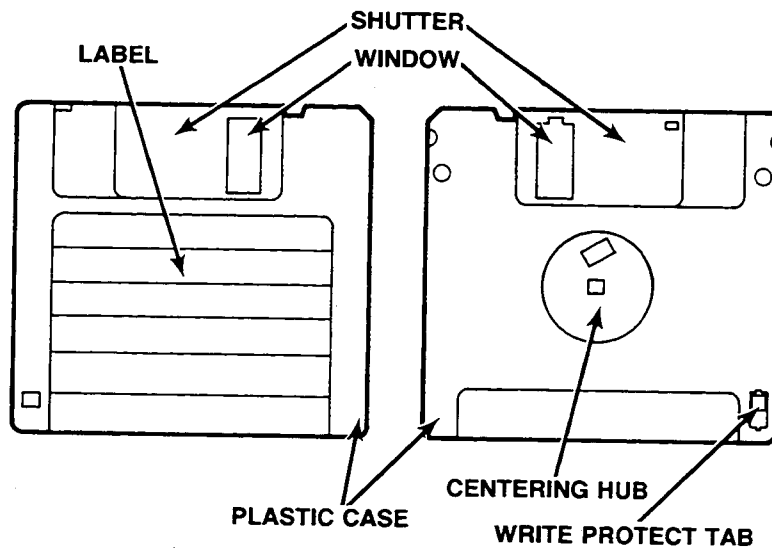

Figure 5-11. Parts of the Flexible Disc

Window and Auto Shutter

The disc drive reads data from the disc and writes data on the disc in the space under the window. The window is covered by a metal shutter. The shutter helps protect the disc surface from dust particles and fingerprints.

The flexible disc is equipped with an auto shutter. When the disc is placed in the drive, the shutter is opened automatically to expose the disc surface. You do not need to manually open the shutter before inserting the disc in the drive.

NOTE

The original 3-1/2 inch flexible discs did not have the auto shutter feature. Only flexible discs with the auto shutter feature work with the 4195A.

Centering Hub

On the back of the plastic jacket is a round metal center piece called the "centering hub". The centering hub ensures accurate positioning when the disc is inserted in the drive.

5-18-9. LOADING THE FLEXIBLE DISC

Insert and remove flexible discs as follows. Refer to Figure 5-12.

1. Hold the disc with the label side of the disk up and the shutter pointing into the disc drive slot. Slide the disc into the drive until you feel the disc drop down into the slot. Do not force the disc! Make sure that the disc is seated completely.
2. Remove the disc by pressing the disc eject button. Pull the disc straight out. Make sure that the shutter closes.

CAUTION

Do not insert or remove the flexible disc while the access lamp is ON.

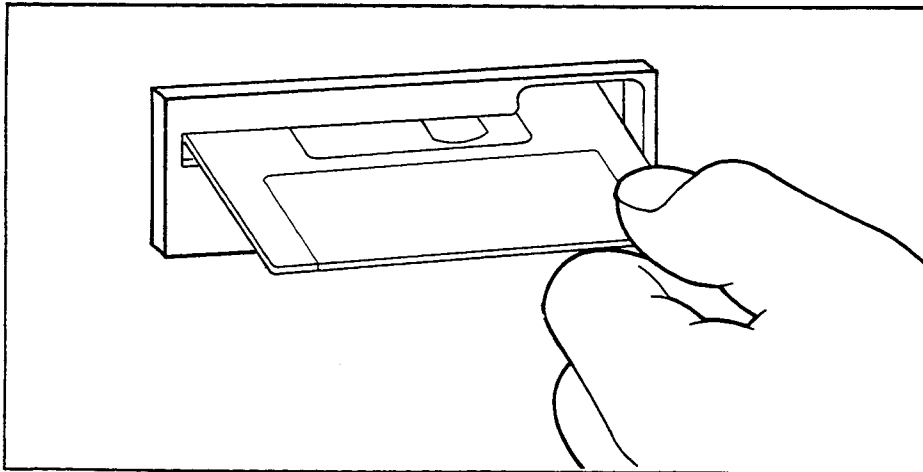

Figure 5-12. Proper Loading of the Flexible Disc

NOTE

A protective plastic dummy disc is inserted into the 4195A disc drive when it is shipped from the factory. Hewlett-Packard recommends that the dummy disc be left inserted when the 4195A's disc drive is not in use, especially when the 4195A is being moved.

5-18-10. FORMATTING (INITIALIZING)

All discs must be initialized (formatted) to prepare them to receive data. Think of your disc as being like a file cabinet, formatting is equivalent to getting an empty file cabinet and preparing the cabinet for use. First, you check the cabinet for any damage. Similarly, the disc drive checks the disc for any damaged areas in which data cannot be stored. Second, you place hanging folders and dividers in your file cabinet. Likewise, the disc drive sets up storage areas on the disc. Finally, you label your file cabinet so that you know what is in each drawer. Similarly, the disc drive sets up a directory on your disc.

The flexible disc used for the 4195A can hold 630 K bytes of data after it is formatted (initialized).

The disc format used with the 4195A is the Logical Interchange Format (LIF), the format that is used by most HP disc drives.

Format a disc as follows.

1. Insert the flexible disc to be initialized into the disc drive.
2. Press the **SPECIAL FUNCTION SAVE/GET** key.
3. Press the 'more 1/2' and 'format DISC' softkeys, then the "Enter to execute **FORMAT DISC**" message and "FORMAT" will be displayed on the system message line and the keyboard input line, respectively.
4. Confirm that you really want to initialize the disc, then press the **ENTER/EXECUTE** key.

CAUTION

All previously stored data in the disc will be erased, when the disc is formatted (initialized).

NOTE

Initialization will take approximately one minute then the message "**FORMAT completed**" will be displayed when the disc has been initialized. During the formatting, the front panel keys are locked out.

If "**Write protected**" is displayed, the disc is write protected. Refer to paragraph 5-18-17, WRITE PROTECT TAB.

If "**FORMAT failed**" is displayed, the disc may be defective, and it is not recommended to use the disc.

5-18-11. STORING DATA

In order to save data on the disc, perform the following procedure.

1. Press the **SAVE/GET** key, and '**SAVE**' softkey. Softkey labels will be displayed for selecting the data type to use for saving the data.
2. Press one of the following softkeys, '**STATE**', '**PROG TABLE**', '**DATA**', and '**PROGRAM**'. '**SAVES**', '**SAVET**', '**SAVED**', or '**SAVEP**' will be displayed on the keyboard input line, respectively.
3. Enter the file name using the **blue** or **green** shift keys.

NOTE

Characters that can be used in the file name are upper-case alphabetical characters (**A** to **Z**) and an underscore (**_**). The maximum number of characters in a file name is ten.

4. Press the **ENTER/EXECUTE** key.

NOTE

To resave data on a disc, to purge an old file and save the updated file using the same file name, use the '**RESAVE**' softkey in place of the '**SAVE**' key.

5-18-12. DISPLAYING THE FILE CATALOG

To view the contents of a disc, perform the following procedure.

1. Press the **SAVE/GET** key, and the '**CAT**' softkey.

5-18-13. RETRIEVING DATA

To retrieve data from a file on a disc, perform the following procedure.

1. Press the **SAVE/GET** key, '**CAT**' and '**GET**' softkeys. **GET**"(first file name)" will be displayed on the keyboard input line.
2. Using the **up/down** arrow keys, scroll through the catalog entries until the desired file name is displayed on the keyboard input line.
3. Press the **ENTER/EXECUTE** key.

5-18-14. PURGING A FILE

In order to purge an unnecessary data file from the disc, perform the following procedure.

1. Press the **SAVE/GET** key, '**CAT**' and '**PURGE**' softkeys. **PURGE**"(first file name)" will be displayed on the keyboard input line.
2. Using the **up/down** arrow keys scroll through the catalog entries until the desired file name is displayed on the keyboard input line.
3. Press the **ENTER/EXECUTE** key.

5-18-15. RECOVERING A FILE

To recover a data file which has been purged form a disc, perform the following procedure.

1. Press the **SAVE/GET** key, '**more 1/2**', '**RECOV. files**' and '**RECOVER**' softkeys. **RECOVER**"(first recoverable file name)" will be displayed on the keyboard input line.
2. Use the **up/down** arrow keys to scroll through the catalog entries until the desired file name is displayed on the keyboard input line.
3. Press the **ENTER/EXECUTE** key.

5-18-16. DISC CAPACITY

Data is stored in 256-byte sectors on the 4195A's flexible disc, and a formatted flexible disc can hold a maximum of 2440 sectors. The remaining number of usable sectors (2440 minus the number of sectors already used) is displayed in the file catalog display. The 4195A can manage up to 192 files per disc. Table 5-9 lists the data length (in sectors) for all data types.

NOTE

In the file catalog display, "AVAILABLE SECTOR" is the total number of unused sectors. A data file cannot be saved for the the following reasons.

1. 192 files already exist on the disc, even though there may be enough available space (unused sectors).
2. The remaining unused sectors on the disc are fragmented and there are not enough contiguous sectors to store the file even though the catalog display says there are enough sectors to store the file.

Table 5-9. Stored Data Length

Storing Data	Data Size
Program Point Table	16 sectors
User Program (ASP) ¹	1 sector
Register Data (A, B, and R0 through R99)	30 sectors
Instrument Settings (without CAL data)	21 sectors
Instrument Settings (Network Reflection CAL on)	109 sectors
Instrument Settings (Network Reflect/Trans CAL on)	134 sectors
Instrument Settings (S11 and S22 CAL on)	197 sectors
Instrument Settings (S11 or S22 CAL on)	109 sectors
Instrument Settings (S21 and S12 CAL on)	97 sectors
Instrument Settings (S21 or S12 CAL on)	59 sectors
Instrument Settings (All S-parameter CAL on)	272 sectors
Instrument Settings (Impedance CAL on)	109 sectors
Instrument Settings (Impedance Compensation on)	59 sectors
Instrument Settings (Impedance CAL/Compen. on)	134 sectors
Instrument Settings (All Netwk/Impdnce CAL/Compen on)	247 sectors
Instrument Settings (All S-prmtr CAL/Impdnce Cmpn on)	310 sectors

¹: When a 5-line program with 40 characters per line is saved.

5-18-17. WRITE PROTECT TAB

Double-sided, 3 1/2-inch discs are equipped with a write protect tab (see Figure 5-13). Write protecting prevents the data on a disc from being overwritten or erased accidentally. Make backup copies and write protect discs that contain valuable data.

To write protect a disc, use the tip of a ball point pen to slide the write protect tab over until the write protect window is open and the tab locks into place. Slide the tab over to cover the write protect window, make sure the tab locks into place. If the write protect tab is missing from a disc, the disc is write protected. To override the write protected disc due to a missing write protect tab, place tape over the tab window.

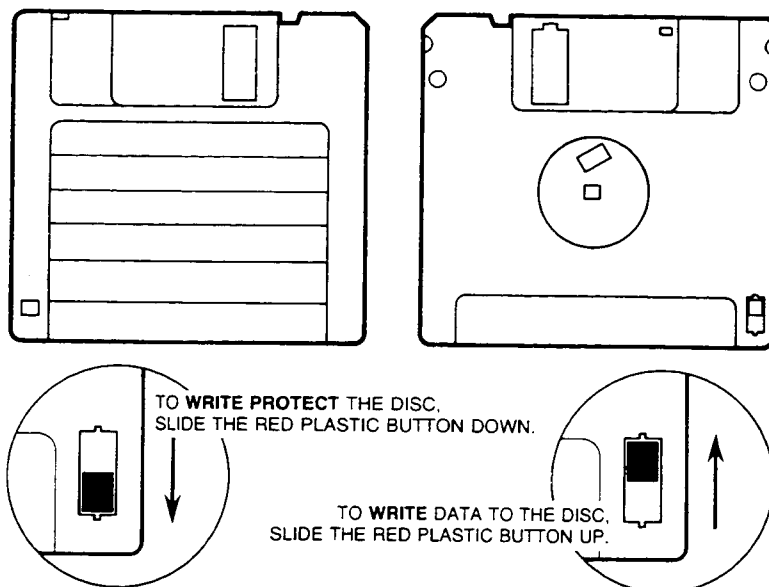

Figure 5-13. Write Protect Tab
5-52

5-18-18. LABELING A FLEXIBLE DISC

When you order a box of flexible discs, you will receive a packet of labels with the discs. Note that the labels come in a variety of colors. Position the label on the disc so that the colored portion of the label is folded over the edge of the disc at the label position. Write the name of the disc immediately beneath the colored edge of your disc, as shown in Figure 5-14. Use a soft felt tip pen to label your disc, and be careful to write only in the label area.

CAUTION

Write on the label before sticking it on the disc. Writing on the label after it is applied could damage the disc.

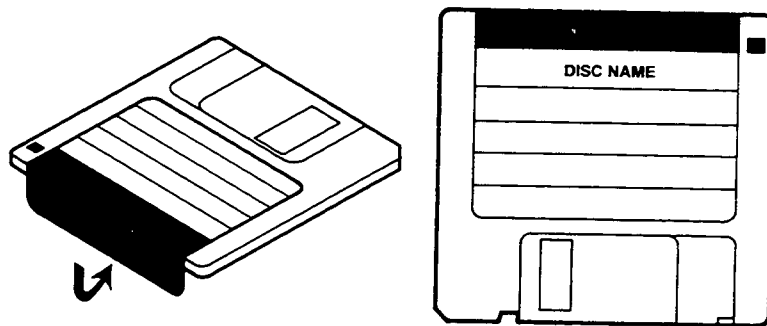

Figure 5-14. Disc Label Position

5-18-19. HANDLING MICRO FLEXIBLE DISC

The following guidelines have been developed to help you prolong the life of both your flexible discs and the disc drive.

1. Make sure the shutter is closed when the disc is not in use to protect the disc from dust, fingerprints, and scratches, all of which can cause loss of data.
2. Use the disc in a clean environment to minimize the risk of dust or dirt particles scratching the disc and causing loss of data.
3. Store the disc in a cool, dry, fireproof place, and do not expose them to direct sunlight to prevent moisture and heat damage.
4. Do not place the disc anywhere close to objects which produce magnetic fields, motors, transformers, magnets, or placing a box of discs on top of or beside an instrument or CRT display to prevent magnetically erasing the data on your discs.

5. Do not touch the surface of the disc. Particle contamination, finger prints, can scratch the disc or cause the disc and the read/write head of the disc drive to wear out sooner than normal, and result in loss of data.
6. Do not try to clean the disc. The plastic jacket contains a mechanism for cleaning the disc surface. Other cleaning methods will damage the disc.

5-18-20. MAKING BACK UP COPIES

There is always a chance of losing disc data. The best protection against data loss is frequent back up of your files. To make a back up copy of important data files, "**GET**" the data from the original disc and "**SAVE**" the data to the back up disc, for each file.

If you have an HP desk-top computer, such as HP 9000 series 200/300 with a dual 3 1/2-inch disc drive, you can copy entire disc files easily. An example (BASIC language system) is shown below.

```
COPY ":CS80,700,0" TO ":CS80,700,1"
```

5-18-21. EDITING A SAVED FILE USING A DESK-TOP COMPUTER

The saved 4195A register data and user program (ASP) can be edited on an HP desk-top computer, such as an HP 9000 series 200/300 with a 3 1/2-inch disc drive.

1. Editing the User Program (ASP)

A 4195A User Program (ASP) can be created or edited on a computer. In order to get/save a User Program file from/to a disc using a computer, use the **GET/SAVE** (or **RE-SAVE**) commands so that the program is recorded as an ASCII file. (Don't use the **LOAD/STORE** commands.)

NOTE

Be careful that length of any program line (excluding the line number) does not exceed 81 characters. If there is one or more program lines that contains statement longer than 81 characters, the "**Improper file type**" error message will be displayed when the file is intended to be retrieved by the 4195A.

When the 4195A saves (or resaves) a User Program to a disc, it automatically includes an exclamation mark (!) after the line number of each program line. When the 4195A "GETS" a User Program from a disc, it ignores and removes the first exclamation mark (!) from each program line.

NOTE

When editing on a computer:

1. Include an exclamation mark (!) at the beginning (after the line number) for User Program statements that are not allowed by the HP-BASIC syntax, but which are allowed in the User Program syntax (such as **START=10HZ;STOP=500MHZ**, etc.).
2. No exclamation mark is required for program statements that are allowed by both HP-BASIC syntax and the 4195A User Program syntax, such as **GOTO 20, DISP R1**, etc..
3. Attach two or more exclamation marks for program lines that are **remarks** statement both in HP-BASIC and the User Program.

2. Editing Register Data

The 4195A's register data can be edited with a computer, because the register data is stored in the REAL format (IEEE-standard, 64-bit, floating-point notation) of BDAT file.

Figure 5-15 shows a sample program that reads register data from a disc, prints the register data, and then rewrites the data to the disc using an HP desktop computer.

```

10  OPTION BASE 1
20  DIM A(401),B(401),R(100)
30  INTEGER I
40!Read Data from "DATA_FILE" File on the Disc
50  ASSIGN @Buffer TO "DATA_FILE"
60  ENTER @Buffer;A(*),B(*),R(*)
70  ASSIGN @Buffer TO *
80!Print Data
90  FOR I=1 TO 401
100  PRINT USING Image_1;I,A(I),I,B(I)
110  NEXT I
120  FOR I=1 TO 100
130  PRINT USING Image_2;(I-1),R(I)
140  NEXT I
150 Image_1:IMAGE "A(",3D,")=",X,SD.14DE,3X,"B(",3D,")=",X,SD.14DE
160 Image_2:IMAGE "R",2D,"=",X,SD.14DE
170!Write Data to "DATA_FILE" File on the Disc
180  ASSIGN @Buffer TO "DATA_FILE"
190  OUTPUT @Buffer;A(*),B(*),R(*)
200  ASSIGN @Buffer TO *
210  END

```

Figure 5-15. Register Data Editing Sample Program

For more detailed information, refer to the **Data Storage and Retrieval** chapter of the **BASIC Programming Techniques** manual that came with the computer.

SECTION 6

PROGRAMMING

6-1. INTRODUCTION

Measurement and analysis (controlling the operation of the 4195A) can be performed with only a few key strokes by using the following capabilities of the HP 4195A.

USER DEFINED FUNCTION
SWEEP END FUNCTION
USER PROGRAM (Auto Sequence Program: ASP)
HP-IB function

This section describes these capabilities, their command syntax, and gives programming examples.

6-2. COMMAND SYNTAX

This paragraph describes the command syntax of the 4195A device dependent commands. The 4195A device dependent commands are unique commands used to control the 4195A's operation. Most of the commands which correspond to the keys and softkeys on the 4195A's front panel, are 4195A device dependent commands.

These commands are classified into the following six syntax types. The command syntax diagram is shown in Table 6-1.

1. Header only type
2. Numeric data type
3. Multiple numeric data type
4. String data type
5. Select type
6. Others

NOTE

The syntax type for any command can be found in APPENDIX E, COMMANDS LIST.

6-2-1. HEADER ONLY TYPE

Header Only Type Commands are constructed of a header only. The **AUTO**, and **COPY** commands are examples included in this type. The syntax diagram is shown in Type 1 of Table 6-1.

6-2-2. NUMERIC DATA TYPE

The Numeric Data Type Commands are constructed of a header, an equal sign (=), and a numeric expression. These commands are used to enter data into registers, as follows.

ex) **START= 100 MHZ**
STOP= MKR

The syntax diagram is shown in Type 2 of Table 6-1.

6-2-3. MULTIPLE NUMERIC DATA TYPE

The Multiple Numeric Data Type Commands are constructed of a header, an equal sign (=), and numerical expressions separated by commas. The **POINT**, and **PSCALE** commands, are included in this type. This type is classified into three types as shown in Type 3, 4 and 5 of Table 6-1.

6-2-4. STRING DATA TYPE

The String Data Type Commands are constructed of a header, and any characters enclosed by a pair of double or single quotation marks. This type includes the **CMT** and **PROG** commands, and is classified into three types as shown in Type 6, 7 and 8 of Table 6-1.

6-2-5. SELECT TYPE

The Select Type Commands are constructed of a header and a digit. This type includes the **FNC** and **ANA** commands, which are used as follows.

ex) **FNC2**
ANA1

The syntax diagram is shown in Type 9 of Table 6-1.

6-2-6. OTHERS

There are several commands which do not belong in any of the above syntax types, such as the **INPUT** and **OUTPUT** commands. The syntax diagrams for these commands are shown in Types 10 through 14 of Table 6-1.

Table 6-1. Command Syntax Diagram (1 of 2)

Syntax Type	Diagram
Type 1 (Header) ex) MKMX	
Type 2 (Numeric) ex) START	
Type 3 (Multiple) ex) OPNSTD	
Type 4 (Multiple) ex) POINT	
Type 5 (Multiple) ex) PSCALE	
Type 6 (String) ex) CMT	
Type 7 (String) ex) DISP	

Table 6-1. Command Syntax Diagram (2 of 2)

Syntax Type	Diagram
Type 8 (String) ex) PROG	
Type 9 (Select) ex) FNC	
Type 10 (Other) ex) INPUT	
Type 11 (Other) ex) OUTPUT	
Type 12 (Other) ex) EDIT	
Type 13 (Other) ex) DMA	
Type 14 (Other) ex) LMX	

6-3. USER DEFINED/SWEEP END FUNCTIONS

USER DEFINED FUNCTIONS and **SWEEP END FUNCTIONS** provide the ability to define single key stroke functions to replace multiple key and softkey combinations. The User Defined Function and the Sweep End Function are defined using the same procedure, but their operations are different; the User Defined Function works when the defined softkey is pressed, and the Sweep End Function is performed at the end of the sweep. These capabilities are used for the following uses.

- Press a single softkey to setup a frequently used measurement setup.
- Press a single softkey to read a parameter (ex. XdB Bandwidth, C/N, S/N, and etc.).
- Perform Alternate Sweep measurements, etc.

6-3-1. SOFTKEY/COMMAND FOR THE USER DEFINED/SWEEP END FUNCTION

The following paragraphs describe the softkeys/commands used for the User Defined Function, and the Sweep End Function. To display the softkey menus for these functions press the **USER DEFINE** key. Before reading the next paragraph, refer to the APPENDIX D, Softkey Tree.

6-3-2. PERFORM USER DEFINED FUNCTION/SWEEP END FUNCTION

Five User Defined Functions are available, and can be performed by using the ' 1 ' through ' 5 ' softkeys or by entering the **UDF1** through **UDF5** commands.

NOTE

A User Defined Function cannot be performed from within a User Program (ASP), a Sweep End Function, or from within User Defined Function, so the **UDF1** through **UDF5** commands cannot be used in a User Program (ASP), a Sweep End Function, or another User Defined Function.

The ' **A** ', ' **B** ' and ' **C** ' softkeys or the **SEFA1**, **SEFB1**, and **SEFC1** commands are used to perform the Sweep End Function. Three Sweep End Functions are available. The Sweep End Function can be performed at the end of every sweep, when the softkey label is green, or when a **SEFA1**, **SEFB1**, or **SEFC1** command is entered, will continue to be performed until a **SEFA0**, **SEFB0**, or **SEFC0** command is entered.

NOTE

When the **SEFA1** (or 0), **SEFB1** (or 0), and **SEFC1** (or 0) commands are used in a User Program, the function cannot be performed, but the on/off part of the softkey can be set. When a User Program is running, the Sweep End Function is not available.

6-3-3. DEFINE USER DEFINED FUNCTION/SWEEP END FUNCTION

The 'fctn1' through 'fctn5' softkeys, or the DF1 through DF5 commands are used to define a User Defined Function.

The 'fctnA' through 'fctnC' softkeys or the DFA through DFC commands are used to define the Sweep End Function.

When any of the these softkeys are pressed, the 4195A enters into the UDF editor mode, and the following commands are displayed on the keyboard input line.

```
DF1" " (DF2" ", DF3" ", DF4" ", or DF5" ")
or
DFA" " (DFB" ", or DFC" ")
```

The User Defined Function and the Sweep End Function are defined by entering the required commands for the function to be defined between double quotation marks (") and separated by semicolons (;). When the definition of the User Defined Function or Sweep End Function is completed, press the **ENTER/EXECUTE** key to store the function. The total number of characters entered between two double-quotation marks must be less than 83 characters. If the User Defined Function is defined using the "DF1" command, the ' 1 ' softkey will perform the defined function.

NOTE

Commands in which multi-statements are allowed, can be used to define User Defined Functions and Sweep End Functions. In APPENDIX E, Command List, commands in which multi-statements are not allowed, are marked with a bullet ' • '.

NOTE

All commands are entered using the alphabet keys, or by pressing the softkey or key which corresponds to the command. For example, the **MKMX** command can be entered by pressing the 'MKR→MAX' softkey, or by entering **M**, **K**, **M**, and **X**. In the UDF editor mode, the function of the softkey is not performed but the corresponding command is displayed when the softkey is pressed.

6-3-4. EXIT USER DEFINED FUNCTION/SWEEP END FUNCTION EDITOR

When the definition of a User Defined Function or Sweep End Function is completed, the **ENTER/EXECUTE** key is pressed to enter the function. The 4195A will exit from the UDF editor mode when the **ENTER/EXECUTE** key is pressed.

If you want to exit from the UDF editor mode without storing the function, press the 'EXIT UDF edit' softkey or the 'EXIT SEF edit' softkey.

6-3-5. LABELING A DEFINED SOFTKEY

The softkey labels for the User Defined Functions and Sweep End Functions can be changed, the label length is 15 characters maximum.

To enter the softkey labels for the ' 1 ' through ' 5 ' softkeys, the 'fctn1 KEY LBL' through 'fctn5 KEY LBL' softkeys or the LBL1 through LBL5 commands are used.

To enter the softkey label of the ' A ' through ' C ' softkeys, the 'fctnA KEY LBL' through 'fctnC KEY LBL' softkeys or the LBLA through LBLC commands are used.

When any of these softkeys are pressed, the following corresponding messages are displayed on the keyboard input line.

LBL1" " (LBL2" ", LBL3" ", LBL4" ", or LBL5" ")
 or
 LBLA" " (LBLB" " or LBLC" ")

The softkey is labeled by entering the characters, between two double-quotation (") marks.

NOTE

After the new label is entered, the letter or number character on the softkeys previous label (1, 2, 3, 4, 5, A, B, or C) remains on the new softkey label. For example, if you enter the LBL1"XYZ" command to label the UDF 1 softkey, the softkey label is changed from ' 1 ' to 'XYZ 1'.

NOTE

The function and label for User Defined Functions and Sweep End Functions are stored in the battery powered back-up memory. They can also be stored on a Flexible Disc, as a part of the instrument STATE.

6-3-6. Using Example

This paragraph describes how to use User Defined Functions, and Sweep End Functions.

The following three examples will be given.

Example 1: Measurement Condition Set-up (User Defined Function)

Example 2: -3 dB Bandwidth (User Defined Function)

Example 3: Signal Track Function (Sweep End Function)

Example 1: Define User Defined Function 1 (UDF 1) to set the measurement conditions, and then perform UDF 1

MEASUREMENT CONDITION:

MEASUREMENT FUNCTION:	SPECTRUM
MEASUREMENT UNIT:	dBm
TEST PORT:	T1
CENTER FREQUENCY:	100 MHz
SPAN FREQUENCY:	10 MHz
SOFTKEY LABEL:	SETTING NO.1

Table 6-2 lists the key strokes to define the function and label for example 1.

NOTE

To enter the alphabetical characters 'A' to 'U', the **blue** key must be pressed (blue key indicator on). To enter 'V' to 'Z', the **green** key must be pressed before the alphabetical key is pressed, for every keystroke.

Table 6-2. Procedure to Define the User Defined Function (Example 1)

Key Stroke	Display on Keyboard Input Line
<u>USER DEFINE</u> , 'DEFINE FCTN', 'fctn 1'	DF1 " "
<u>CONFIG</u> , 'SPECTRUM', ; (or F,N,C,2, ;)	DF1 "FNC2;"
'PORT SELECT', 'SPECTRUM', 'T1', ; (or P,O,R,T,2, ;)	DF1 "FNC2;PORT2;"
<u>FORMAT</u> , 'SPECTRUM', 'dBm', ; (or S,A,P,1, ;)	DF1 "FNC2;PORT2;SAP1;"
<u>CENTER</u> , 1,0,0,M, ; (or C,E,N,T,E,R,=,1,0,0,M, ;)	DF1 "FNC2;PORT2;SAP1;CENTER=100M;"
<u>SPAN</u> , 1,0,M (or S,P,A,N,=,1,0,M)	DF1 "FNC2;PORT2;SAP1;CENTER=100M; SPAN=10M"
<u>ENTER/EXECUTE</u>	(UDF1 is defined.)
<u>USER DEFINE</u> , 'KEY LBL entry', 'fctn1 KEY LBL'	LBL1 " "
S,E,T,T,I,N,G,(space),N,O,(period),1	LBL1 "SETTING NO.1"
<u>ENTER/EXECUTE</u>	(Label '1' is changed to 'SETTING NO.1 1'.)
<u>USER DEFINE</u> , 'SETTING NO.1 1'	(UDF1 is performed.)

- NOTE:** 1. Under-lined characters indicate a key on the 4195A's front panel (ex: CONFIG indicates the **CONFIG** key).
2. Characters between two single-quotation marks indicate a softkey (ex: 'SPECTRUM' indicates the 'SPECTRUM' softkey).

Example 2: Define User Defined Function 2 (UDF 2) to get the -3 dB Bandwidth, and then perform UDF 2.

Table 6-3 shows the key strokes used to define the function and label for example 2.

Table 6-3. Procedure to Define the User Defined Function (Example 2)

Key Stroke	Display on Keyboard Input Line
<p><u>USER DEFINE</u>, 'DEFINE FCTN', 'fctn 2'</p> <p><u>MODE</u>, 'o&LCRS', ; (or M,C,F,4, ;)</p> <p><u>MKR</u>→, 'Δ mode on off', 1, ; (or D,E,L,T,1, ;)</p> <p>'WIDTH on off', 1, ; (or W,I,D,T,H,1, ;)</p> <p>'MKR→MAX', ; (or M,K,M,X, ;)</p> <p>'Δ VALUE entry', - , 3 (or LCURS=-3)</p> <p><u>ENTER/EXECUTE</u></p>	<p>DF2" "</p> <p>DF2"MCF4;"</p> <p>DF2"MCF4;DELT1;"</p> <p>DF2"MCF4;DELT1;WIDTH1;"</p> <p>DF2"MCF4;DELT1;WIDTH1;MKMX;"</p> <p>DF2"MCF4;DELT1;WIDTH1;MKMX; LCURS=-3"</p> <p>(UDF2 is defined.)</p>
<p><u>USER DEFINE</u>, 'KEY LBL entry', 'fctn2 KEY LBL'</p> <p>-, 3, D, B, (space), B, A, N, D, W, I, D, T, H</p> <p><u>ENTER/EXECUTE</u></p> <p><u>USER DEFINE</u>, '-3DB BANDWIDTH 2'</p>	<p>LBL2" "</p> <p>LBL2"-3DB BANDWIDTH"</p> <p>(Label '2' is changed to '- 3 DB BANDWIDTH 2'.)</p> <p>(UDF2 is performed.)</p>

Example 3: Define a signal tracking function for Sweep End Function A (SEF A), and then perform SEF A

Table 6-4 shows the key strokes used to define the function and label for example 3.

Table 6-4. Procedure to Define the User Defined Function (Example 3)

Key Stroke	Display on Keyboard Input Line
<u>USER DEFINE</u> , 'SWP END FCTN', 'fctn A'	DFA " "
<u>MODE</u> , 'oMKR', ; (or M,C,F,1, ;)	DFA "MCF1;"
<u>MKR</u> →, 'MKR→MAX', ; (or M,K,M,X, ;)	DFA "MCF1;MKMX;"
'MKR→CENTER' (or M,K,C,T,R)	DFA "MCF1;MKMX;MKCTR"
<u>ENTER/EXECUTE</u>	(SEF A is defined.)
<u>USER DEFINE</u> , 'SWP END FCTN', 'LBL entry', 'fctnA KEY LBL'	LBLA " "
S,I,G,N,A,L,(space),T,R,A,C,K	LBLA "SIGNAL TRACK"
<u>ENTER/EXECUTE</u>	(Label 'A' is changed to 'SIGNAL TRACK A'.)
<u>USER DEFINE</u> , 'SIGNAL TRACK A'	(SEF A is activated.)

NOTE

Alternate sweep measurements are performed by defining and using two Sweep End Functions. The following example shows how to measure/display reflection/transmission characteristics. In this example, Sweep End Function A and Sweep End Function B are used.

Example:

DFA "RB=MA;DMB=RB;UNITB'DB';PRMB'T';MTHB1;PORT2;SEFA0;SEFB1"
DFB "RA=MA;DMA=RA;UNITA'DB';PRMA'R';MTHA1;PORT1;SEFB0;SEFA1"

LBLA "REFLECTION"
LBLB "TRANSMISSION"

6-4. USER PROGRAM (Auto Sequence Program: ASP)

A USER PROGRAM (ASP) is the 4195A's internal programming capability which makes it possible to automate the 4195A's operation, without an external controller.

6-4-1. COMMANDS USABLE IN ASP PROGRAMS

The commands used in User Programs are classified as follows.

1. 4195A Device Dependent Commands
2. 4195A BASIC Statements
3. 4195A Arithmetic Operators

1. 4195A Device Dependent Commands

Most of the 4195A's device dependent commands can be programmed. When in the User Program (ASP) editor mode, the softkey corresponding to commands are available, so a program can be edited by using the keystrokes used in normal operation.

NOTE

There are commands which cannot be used in a program. For example, the **UDF1** command cannot be used in a User Program. The details of each commands are described in Sections 4, 5, and in paragraph 6-2 through 6-3.

2. 4195A BASIC Statements

The following fifteen BASIC statements can be used in User Programs.

END, IF, THEN, FOR, TO, NEXT, GOTO, GOSUB, RETURN, AND, OR, PAUSE, BEEP, DISP, WAIT

The details of the 4195A's BASIC statements are described in paragraph 6-4-2, HP 4195A BASIC STATEMENTS.

3. 4195A Arithmetic Operators

All of the arithmetic operators listed in Table 5-1, Math Operators, can be used in User Programs. Refer to paragraph 5-3, MATH OPERATORS.

6-4-2. HP 4195A BASIC STATEMENTS

BASIC language statements which can be used in User Programs are introduced here. There are fifteen BASIC program statements, and corresponding softkeys (refer to APPENDIX D, Softkey Tree). These softkeys are displayed by pressing the **PROGRAM** key in the User Program (ASP) editor mode.

NOTE

To enter the ASP edit mode and display the softkey menu, press the **PROGRAM** key, 'EDIT' softkey and **ENTER/EXECUTE** key.

IF . . . THEN

This statement construct provides conditional branching.

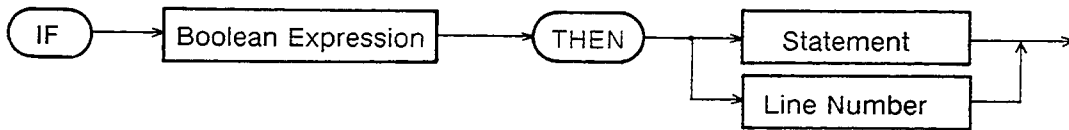

ex) 10 IF A(100) > 5 THEN R0 = 1
 50 IF R0 = 1 AND R1 = 1 OR R2 = 1 THEN GOTO 50
 100 IF R0 AND R1 THEN R2 = 1

-- Boolean expression can include the following symbols, and statements.

=, <>, <, >, <=, >=, AND, OR

-- When **Rn** (n= 0 to 99) is entered as the boolean expression, and if **Rn** is equal to 0 (zero), the boolean expression is judged as false. If **Rn** is not equal to 0 (zero), the boolean expression is judged as true.

FOR . . . TO and NEXT

This construct defines a loop which is repeated until the loop counter passes a specific value.

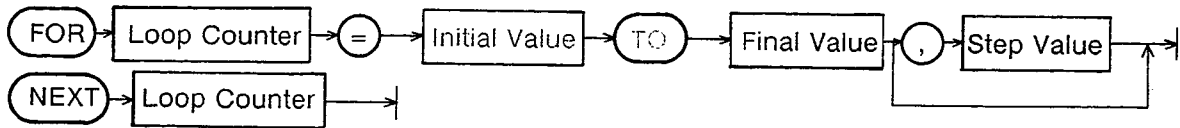

```
ex)   10  FOR R5 = 1 TO 100 , 5
      :
      100  NEXT R5
```

- **Rn** (n= 0 to 99) should be used as the loop counter.
- When the step size is not defined, it is automatically set to either +1 or -1 according to the values input.
- Single variables **Rn** (n= 0 to 99) can be used as the initial value, final value, and step size. Single variables (MKR, START and etc.) can be used as the initial value.
- The maximum nesting level for the **FOR ... TO ... NEXT** construct is 10.

GOTO

GOTO transfers program execution to the specified line. The specified line must exist within the program.

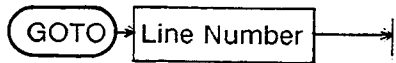

```
ex)   100  GOTO 10      ( Jump to line number 10 )
```

GOSUB and RETURN

GOSUB and **RETURN** transfers program execution to a subroutine at the specified line. The specified line must exist within the program. The current program line is remembered in anticipation of a **RETURN** instruction.

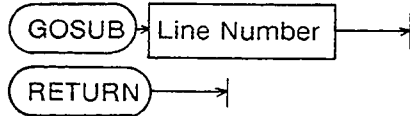

```

ex)      :
          10  GOSUB 200      ( Jump to subroutine starting at line number 200 )
          20  SWTRIG
          :
          200  START = 1 MHZ  ( Start of subroutine )
          :
          300  RETURN        ( End of subroutine. Return to line number 20 )
          :
  
```

-- The maximum nesting level for a **GOSUB ... RETURN** construct is 10.

AND and OR

AND is the logical-AND operator, and **OR** is the logical-OR operator. These statements can be used only within an **IF** construct.

PAUSE

PAUSE suspends program execution until one of the following program control commands are executed. Softkeys are provided for program control commands. The program control commands are explained in paragraph 6-4-3.

- CONT(inue)** Causes the program to continue at the next step.
- RUN** When the '**RUN**' softkey is pressed, the program will start over again from the beginning of the program.
- STEP** When the '**STEP**' softkey is pressed, the next program line will be executed.
- STOP** Press the '**STOP**' softkey to stop program execution.

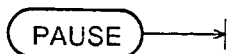

```

ex)      50  PAUSE          ( Program execution is suspended here. )
  
```

NOTE

A User Program can be started by inputting a start signal through the PROGRAM START connector. Refer to paragraph 6-4-7, PROGRAM START CONNECTOR.

BEEP

BEEP causes the 4195A to emit an audible tone for 150 msec.



ex) 50 BEEP (The instrument will beep)

WAIT

WAIT causes the instrument to wait approximately the number of milliseconds specified by the number following the statement. The wait time range is from 0 to approximately 10 minutes. Setting resolution is 10 msec. If WAIT 153 is set, the wait time is rounded off to 150 msec.

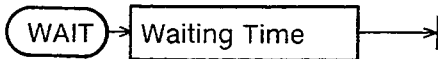

ex) 50 WAIT 535 (wait time = 540 msec)

DISP

DISP will display either a comment or the contents of register **Rn** or both on the System Message line.

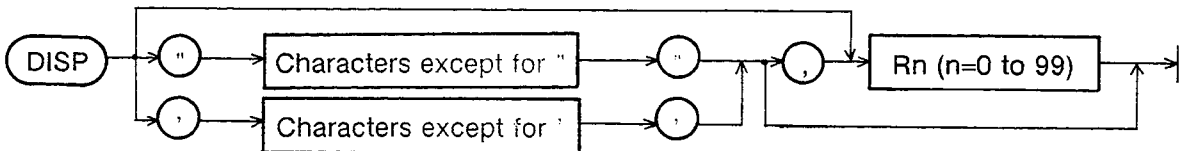

ex) 10 DISP"R1=" , R1 (Display 'R1= (contents of R1)')
 50 DISP" ABC " (Display 'ABC')

NOTE

DISP can be used not only in a User Program, but also all other modes. Refer to paragraph 5-16-2.

END

END marks the end of the program, and when it is executed the program will stop.

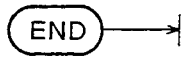

ex) 300 **END** (Program ends here)

! (Remark sign)

The remark sign (!) is used to input a comment on a program line.

ex) 100 **SWTRG** **! SWEEP START**

6-4-3. PROGRAM CONTROL COMMANDS

The following nine commands are used to control User Programs (ASP), and are mainly used via HP-IB.

RUN, PSTOP, PPAUSE, CONT, PSTEP, EDIT, QUIT, SCRATCH, PROG

Except for the **PROG** and **QUIT** commands, these commands correspond to the softkeys displayed after the **PROGRAM** key is pressed, and they initiate the same action. **QUIT** corresponds to the 'QUIT editor' softkey in the User Program (ASP) editor mode softkey menu. The 'EDIT' and 'SCRATCH' softkeys are not executed until the **ENTER/EXECUTE** key is pressed. Other softkey commands are executed immediately when pressed.

RUN ('RUN' softkey)

RUN starts execution of the program in the work area. A program will always start from the beginning. While the program is running, all softkeys and keys are deactivated, except for the 'STOP' and 'PAUSE' softkeys.

PSTOP ('STOP' softkey)

PSTOP terminates program execution. While in the STOP state, the **CONT** command is not effective, however the **STEP** command can be used to single step a program from the beginning of the program.

PPAUSE ('PAUSE' softkey)

PPAUSE suspends program execution. If the **CONT** or **STEP** commands are sent, program execution will start from the next line. If the **RUN** command is sent, the program will start from the beginning. All key and softkey inputs are accepted while in the **PAUSED** state.

CONT ('CONT' softkey)

CONT resumes execution of a paused program at the command after which the **PPAUSE** command was received. This command is effective only while in the **PAUSED** state.

PSTEP ('STEP' softkey)

PSTEP performs single step execution of a program. In the **STOP** state, **PSTEP** single steps the program from the beginning. In the **PAUSE** state, the **PSTEP** single steps a program starting at a specified line number.

EDIT ('EDIT' softkey)

EDIT is used to enter to the User Program (ASP) editor mode to edit a program. If you send the **EDIT** command, the cursor will appear at the top of the program on the edit page. If you send the **EDIT** command followed by a line number, the cursor will appear at the program line number specified.

NOTE

If the **EDIT** command is sent after the program is stopped by the '**STOP**' softkey or the **PSTOP** command, the cursor will be positioned on the program edit line which was being executed when the **PSTOP** command was sent.

QUIT ('QUIT editor' softkey)

QUIT is used to exit from the User Program (ASP) editor mode (quit the program edit).

SCRATCH ('SCRATCH' softkey)

SCRATCH is used to delete the program from the work area.

PROG

This command is used to enter a User Program (ASP) without using the editor. This command has the syntax shown in Type 8 of Table 6-1, paragraph 6-2. An ASP program can be edited by entering the following command, from the keyboard input line.

PROG " 100 SWTRG "

A User Program (ASP) can be entered via HP-IB. An example of entering a User Program (ASP) via HP-IB, is shown in Paragraph 6-5-8, Example 4.

6-4-4. HOW TO EDIT A USER PROGRAM (ASP)

1. How to Enter/Exit the Edit Mode

To enter to the User Program (ASP) editor mode (edit page), perform the following procedure.

1. Press the **PROGRAM** key, then the softkey menu to control the User Program (ASP) is displayed.
2. Press the **'EDIT'** softkey, "EDIT" will be displayed on the keyboard input line.
3. Press the **ENTER/EXECUTE** key. Then the 4195A's display is changed to the edit page, and the cursor appears at program line 10.

NOTE

If you want to edit line number 100 (or to start editing from line number 100), press the **'EDIT'** softkey, **1**, **0**, and **0**, in step 2. The edit page will be displayed with the cursor at program line 100, after performing step 3.

To exit from the User Program (ASP) editor mode, press the **'QUIT editor'** softkey.

2. How to Enter Commands

Most of the 4195A device dependent commands can be entered by pressing the softkey or key which corresponds to the command. All commands can be entered using the alphabet keys. An example of entering the User program (ASP) is shown in Table 6-5.

If a User Program (ASP) program is edited by using softkeys, the commands can be entered in the sequence same as would be used for normal front panel operation, but some of the softkey menus in the User Program (ASP) edit mode are different from the menus in normal operation.

For example, there is an additional softkey menu between the softkey menu which includes the **'PORT SELECT'** softkey and the menu used to select the test port (input terminal) in the User Program (ASP) editor mode. So, in line number 30 of Table 6-5, the **'SPECTRUM'** softkey has been pressed, after pressing the **'PORT SELECT'** softkey.

NOTE

To enter the characters **'A'** to **'U'**, the **blue** key must be turned on. To enter **'V'** to **'Z'**, the **green** key must be pressed before the alphabetical key is pressed.

Table 6-5. ASP Editing Example

PROGRAM	KEYSTROKE	
	SOFTKEY and KEY	ALPHABET KEY
10 FNC2	<u>CONFIG</u> , <u>'SPECTRUM'</u> , <u>ENT</u>	F,N,C,2, <u>ENT</u>
20 RST	<u>PRESET</u> , <u>ENT</u>	R,S,T, <u>ENT</u>
30 PORT4	<u>(CONFIG)</u> , <u>'PORT SELECT'</u> , <u>'SPECTRUM'</u> <u>'T2'</u> , <u>ENT</u>	P,O,R,T,4, <u>ENT</u>
40 CENTER=10MHZ	<u>CENTER</u> ,1,0, <u>MHZ</u> , <u>ENT</u>	C,E,N,T,E,R,=,1,0,M,H,Z, <u>ENT</u>
50 SPAN=1MHZ	<u>SPAN</u> ,1, <u>MHZ</u> , <u>ENT</u>	S,P,A,N,=,1,M,H,Z, <u>ENT</u>
60 SWTRG	<u>TRIG/RESET</u> , <u>ENT</u>	S,W,T,R,G, <u>ENT</u>
70 MKMX	<u>MKR→</u> , <u>'oMKR menu'</u> , <u>'MKR→MAX'</u> , <u>ENT</u>	M,K,M,X, <u>ENT</u>
80 END	<u>PROG</u> , <u>'END'</u> , <u>ENT</u>	E,N,D, <u>ENT</u>

- NOTE:** 1. ENT indicates the ENTER/EXECUTE key.
2. Under-lined characters indicate a key on the 4195A's front panel.
3. Characters enclosed in ' and ' (ex. 'END') indicate a softkey.

NOTE

When the 4195A is turned off, the User Program (ASP) in the work area is cleared. So, store the program on a flexible disc by using the internal flexible disc drive, or print the program listing. How to store the program is described in paragraph 5-18, and how to print the program listing is described in paragraph 5-13.

6-4-5. EDITING HINTS

This paragraph gives editing hints for User Program (ASP).

1. RST Command

RST resets the 4195A to the same state as would pressing the **PRESET** key. But, when **RST** is used in a User Program (ASP), the **SINGLE** sweep mode is set, whereas the **CONT**(inuous) sweep mode is set when the **PRESET** key is pressed while in the normal operation mode.

2. SWM1 Command

SWM1 sets the 4195A to the continuous sweep mode during normal operation. When the continuous sweep mode is used in a User Program (ASP), the sweep measurement will not be continuously performed. The sweep start timing is dependent on commands used latter in the program. So the recommend use for **SWM1** is to set the stimulus/receiver controls for manual (front panel) operation. When **SWM1** is executed within a program, the 4195A will start continuous sweep when the program is stopped or paused. Select the single sweep mode (**SWM2**) in an ASP program to make a sweep measurement.

3. SWTRG Command

SWTRG is used to start a sweep measurement. When **SWTRG** is used within a User Program, the 4195A's operation is different for the **TRGM1/TRGM2** trigger settings modes, as follows.

Internal trigger mode (**TRGM1**):

SWTRG starts a sweep measurement, and the next program line is executed after the sweep measurement is finished.

External trigger mode (**TRGM2**):

SWTRG arms the trigger to start a sweep, but does not start the sweep, and the next program line is executed. The sweep measurement is not performed. The measurement is started by **TRIG**, as shown in Figure 6-1.

Figure 6-1 shows program examples for a sweep measurement using these two trigger modes.

TRGM1	TRGM2
10 RST	10 RST
20 SWM2	20 SWM2
30 TRGM1	30 TRGM2
40 SWTRG	40 SWTRG
50 MKMX	50 FOR R0= 1 TO 401
60 END	60 TRIG
	70 NEXT R0
	80 MKMX
	90 END

Figure 6-1. Examples of the "SWTRG" Command

4. TRGM2 Command

TRGM2 sets the external trigger mode. When in a User Program , triggering by the 'PT MEAS TRIG' softkey and from the EXT TRIGGER connector are not available. In a User Program, the 'CONT' softkey and the PROGRAM START connector can be used instead, by using the following program.

```

:
100 PAUSE
110 TRIG
:

```

5. SEFA1, SEFB1, and SEFC1 Command

These commands are used to set the Sweep End Function to **on**, but the defined Sweep End Function is not executed even when the sweep measurement is completed. When the following example User Program (1) is executed, the Sweep End Function will not work. The program must be stopped to execute a Sweep End Function. Program example (2) shows how to perform the function of a Sweep End Function in an User Program.

:	:
:	:
100 SEFA1	100 SWM2
110 SWTRG	110 SWTRG
:	120 MKMX;MKCTR;
:	130 GOTO 110
:	:
:	:
(1)	(2)

In program (2), the same commands used to define the Sweep End Function should be entered at program line 120.

6. GET Command

GET is used within a User Program to load 'DATA' and 'PPT' from the 4195A's internal disc drive. But the 'STATE' and 'ASP' cannot be loaded using the **GET** command from within a program.

7. Entering a Select Type Command

When you press the softkey for a select type command, such as **DPA**, a message will be displayed on the System Message Line, such as:

on= 1 , off= 0

These messages are to remind you of what to enter with a command, in this case the digits **1** or **0** to be added to the command to select the states **on** and **off**.

8. Multi Statement

(1) The 4195A device dependent commands:

More than two commands can be programmed in one program line, this technique is called the multi-statement form. A semicolon (;) is the statement separator. The maximum length of a program statement line is 81 characters, including the separators, and spaces (except for the line number and a single space after the line number). But there are some commands which cannot be used in a multi-statement program line. Appendix E: COMMANDS LIST, lists the commands and identifies the commands which can be used in a multi-statement program line. An example of multi-statement input is shown next.

50 FNC1;SWM2;DPBO

(2) HP 4195A BASIC statements:

The **DISP**, and **BEEP** BASIC statements are permitted in multi-statement input. The **GOTO**, **GOSUB**, **RETURN**, **END** statements are permitted, if they are the last statement on a program line. In the **IF . . . THEN** construct, the statements after **THEN** can be multi-statement.

NOTE

Commands input in the multi-statement form will be automatically rearranged internally in the proper order, when the program line is executed.

9. Program Line Number

The usable program line numbers are 1 to 32767. The line number is automatically increased by 10 when entering a line. So, when you enter program line 10, line number 20 will be displayed next.

The maximum number of the characters that can be entered on a program line is 81, this includes the line number, separators, and spaces (except for a single space after the line number). The maximum number of the program lines available on an edit page is 300 lines.

10. Edit Mode

The following keys are used to edit programs.

CLR LINE, DEL CHAR, INS CHAR, RECALL, Arrow Keys (Right, Left, Up, Down)

CLR LINE is used to clear or erase a program line, except for the line number. To erase a program line, move the cursor to the program line to be erased, and press the **CLR LINE** key and then the **ENTER/EXECUTE** key.

The **UP** and **DOWN** arrow keys move the cursor up/down to change the program line being edited. After the green key is pressed, if the **UP** or **DOWN** key is pressed, the displayed program page is changed to the next or previous program page.

To insert a new program line between two existing program lines, use a line number which falls between the two existing program line numbers. For example to insert a new line between line numbers 10 and 20 enter a new program line number from 11 to 19.

To copy a program line, move the cursor to the line to be copied, change the line number to the line number you want to copy the line to, and press the **ENTER/EXECUTE** key.

NOTE

Saving the program on a flexible disc allows you to edit a User Program using the more powerful set of editing functions of an HP desk top computer. Refer to paragraph 5-18, MASS STORAGE.

NOTE

Program syntax errors are not detected when entering a program in the edit mode, program errors are detected at run time.

11. Printing Out Register Data, Measured Data, and Comments

To print the measurement results, comments, etc., directly to a printer, the 4195A provides query commands such as **DISP?**, **CMT?**, and the **SEND** command. Set the 4195A to TALK ONLY and the printer to LISTEN ONLY.

For example,

```

:
100 DISP " BANDWIDTH(HZ)= ", R1
110 DISP?
:
200 MKR?
:
300 SEND " ABC "
:

```

In the preceding program segment when line number 110 is executed, the contents specified by **DISP** will be printed out. When line number 200 is executed, the contents of the MKR register will be printed out. When line number 300 is executed, the characters between two double quotation marks will be printed out.

The details of the query commands are described in paragraph 6-5-3. For more information on the **SEND** command, refer to paragraph 6-5-8.

NOTE

When **DISP?** and **CMT?** are used, data is output in the ASCII format. When the (register)? command; **MKR?**, **R0?**, etc., are used, the data is output in the selected format using the **FMT1** (ASCII), **FMT2** (binary 64-bit), or **FMT3** (binary 32-bit) commands. Select ASCII format to print on a printer. The details of data output formats are described in paragraph 6-5-5.

12. Storing User Programs

The User Program on the work area is lost when the 4195A is turned off, so user programs should be saved on a flexible disc by using the 4195A's disc drive. For more detailed information refer to paragraph 5-18. MASS STORAGE.

6-4-6. HOW TO EXECUTE A USER PROGRAM (ASP)

This paragraph describes how to use an User Program (ASP).

1. Press the **PROGRAM** key to display the softkey menu used to control program execution.

NOTE

The command softkeys used to control program execution are described in paragraph 6-4-3, PROGRAM CONTROL COMMANDS.

2. Press the **'EDIT'** softkey and the **ENTER/EXECUTE** key, and confirm that the program you want to execute is in the work area.

NOTE

The program you want to execute must be in the work area. If the program is stored on a flexible disc, load it to the work area. Refer to paragraph 5-18. MASS STORAGE.

3. Press the **'QUIT editor'** softkey to exit from the editor mode.
4. Press the **'RUN'** softkey to start program execution.

NOTE

If **SEND**, **SENDPS**, **COPY**, or the query command are used in a User Program (ASP), set the 4195A to Talk-only, and connect the Listen-only device, printer, plotter, etc.

When Errors Occur:

Syntax is checked by the system interpreter during program execution, so syntax errors are caught at run time. In addition, setting errors, such as parameter range, and function mode are also checked at run time. When an error is found, the program stops, and a message is displayed on the System Message Line. The Error Messages are listed in Appendixes B, and C. The following is a typical error message.

Error Message	[Line Number]
ex) Multi statement not allowed	[100]

NOTE

If you press the **'EDIT'** softkey and the **ENTER/EXECUTE** key after the error is detected in a User Program (ASP) program, the cursor will be positioned at the program line where the error was detected.

6-4-7. PROGRAM START CONNECTOR

The Program Start Connector is used to input an external TTL level trigger pulse to start/continue User Programs (ASP).

A User Program (ASP) is triggered by the rising edge of a TTL level signal, or with a switch which is normally at ground and connects to 5 V through a pull-up resistor when activated to give the low-to-high transition (creates a rising edge): Refer to Figure 6-2 for the specifications of the input pulse.

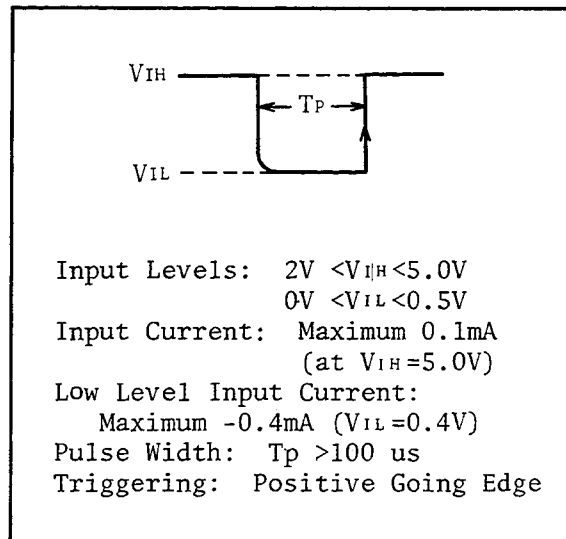

Figure 6-2. Input Pulse

The following program is an example using the **PROGRAM START** connector.

```

10  DISP " PROGRAM STARTED " ; BEEP
20  WAIT 1000
30  DISP " PROGRAM PAUSED "
40  PAUSE
50  DISP " PROGRAM CONTINUED " ; BEEP
60  WAIT 1000
70  GOTO 30
80  END

```

In this example, the User Program is started at program line 10, by an input pulse from the **PROGRAM START** connector. After about 1 sec the program pauses at line 40, and continues from line 50 by the next input pulse. The program loops back to line 30 and repeats.

NOTE

The **EXT TRIG** connector cannot be used to input the trigger pulse during the execution of a User Program. The **PROGRAM START** connector must be used to input the external trigger pulse instead.

A program example for using an external trigger with a User Program is shown next.

```

10 TRGM2
20 R0=1
30 SWTRG
40 PAUSE
50 TRIG
60 IF R0=NOP THEN 20
70 R0=R0+1
80 GOTO 40
90 END

```

6-4-8. HOW TO MAKE A HARD COPY PROGRAM LISTING

A program listing can be printed out by using the procedure described in paragraph 5-13-5, Copy Procedure. This is supplementary information.

- (1) To display the program to be copied on the screen, enter the User Program (ASP) editor, by pressing the 'EDIT' softkey and the ENTER/EXECUTE key.

NOTE

If the program you want to copy is saved on a flexible disc, load the program into the work area. The program load procedure is described in paragraph 5-18, MASS STORAGE. Refer to paragraph 5-18.

- (2) Exit from the User Program (ASP) editor, by pressing the 'QUIT editor' softkey.
- (3) Select the PRINT mode and perform the Copy Procedure in paragraph 5-13-5.

6-4-9. SAMPLE PROGRAMS

Sample User Programs (ASP) are introduced in this section.

Example 1. Ripple Measurement (Network)

Example 2. C/N measurement (Spectrum)

Example 3. Set up the Programmed Points Table

Example 4. Define a User Defined Function, Sweep End Function, and User Math

EXAMPLE 1. This program is used to measure the ripple of a 100 MHz Band-Pass Filter (-3 dB Bandwidth= 500 kHz).

Program Listing:

```

10 CMT"RIPPLE MEAS."
20 FNC1
30 RST
40 GPP1;PORT1
50 CENTER=100 MHZ ;SPAN=500 KHZ
60 SWTRG
70 MCF2;LMX(A)
80 ARSTR;ANA1
90 IF SMKR=STOP THEN R1=0;GOTO 140
100 MKACTION;MKMX
110 MKACTION;MKMN
120 DELT1
130 R1=DMKRA
140 DISP "RIPPLE(DB)=",R1
150 END

```

Line No.	Description
10	Display "RIPPLE MEAS." in the Comment Area.
20	Select the NETWORK measurement function.
30	Initialize the 4195A.
40	Select the T/R(dB)- θ measurement using CHANNEL 1.
50	Set the sweep range using the center and span frequencies.
60	Make a single sweep measurement.
70	Move the o marker to left most peak position, and the * marker to the right most peak position.
80	Set the analysis range between two markers, and enable the partial analysis capability.
90	Display ' RIPPLE(DB)=0 ', if only a peak exists within the measurement range.
100	Activate the * marker, move the * marker to maximum point.
110	Activate the o marker, move the o marker to minimum point.
120	Set the Δ mode on.
130	Store the value of ripple in variable R1.
140	Display the value of ripple on the System Message Line.
150	END

EXAMPLE 2. This program measures the Carrier to Noise (C/N) ratio.

Program Listing:

```

10 CMT "C/N MEAS."
20 FNC2
30 RST
40 PORT2;SAP1
50 CENTER=10 MHZ ;SPAN=10 MHZ ;ATT1=50
60 VFTR1;RBW=30 KHZ
70 SWTRG
80 AUTO;TRGM2
90 R2=R1+1000000
100 MKMX;R1=MKR
110 FOR R0=1 TO 10
120   SWM3;MANUAL=R1
130   TRIG
140   MANUAL=R2
150   TRIG
160   MCF2;MKR=R1;SMKR=R2;DELT1
170   R3=DMKRA/R0+R3*(1-1/R0)
180 NEXT R0
190 DISP "C/N(DBM)=",R3
200 END

```

Line No.	Description
20	Select the SPECTRUM measurement function
40	Set the unit to dBm, and select input port T1
50	Set the sweep range, and set the T1's attenuator to 50 dB
80	Perform auto scaling, and select the external trigger mode
90	Store 'R1+1000000' in variable R2
100	Move the o marker to the maximum point, store the o marker's sweep data in variable R1
110	Select the MANUAL sweep mode, and set the frequency point indicated by R1 to the measurement point
120	Measure the point specified by the "MANUAL=" command
130-140	Measure the point indicated by R2
160	Select the "o&* MKRS" mode, determine the C/N ratio using the maximum peak point and a point 1 MHz away from the maximum peak point
170	Calculate the average C/N ratio

EXAMPLE 3. This program sets the Programmed Points Sweep Table in steps of 80 kHz in the frequency range from 190 MHz to 198 MHz, and from 202 MHz to 210 MHz, and in steps of 20 kHz in the frequency range from 198 MHz to 202 MHz.

Program List:

```

10 FNC1
20 RST
30 !
40 PTN=1
50 PTCLR
60 PTSWP1
70 R1=190M
80 !
90 FOR R0=1 TO 401
100 POINT=R1
110 IF R0<101 OR R0>300 THEN R1=R1+80K;GOTO 130
120 R1=R1+20K
130 NEXT R0
140 !
150 BEEP
160 DISP"PPT SET COMPLETED"
170 END

```

Line No.	Description
10	Select the Network measurement function
40	Select Programmed Points Table 1.
50	Clear table 1.
60	Select frequency sweep.
100	Enter the sweep point indicated by R1.
110	If the point number is less than 101, or greater than 300, add 80000 to R1, and go to program line 130.
120	If the point number is between 101 and 300, add 20000 to R1.
130	Repeat the program lines 100 to 120, until the point number (R0) is 401.

EXAMPLE 4. This program defines the max hold function to User math A, defines a function to get the -3 dB Bandwidth as User Defined Function 1, and defines a signal tracking function as Sweep End Function A.

Program Listing:

```

10 !DEFINE USER MATH
20 DMA=MAX(MA,A)
30 PRMA"MAX"
40 UNITA"DB"
50 !
60 !DEFINE UDF
70 DF1"MCF4;DELT1;WIDTH1;MKMX;DLCURS=-3"
80 LBL1"-3DB BAND WIDTH"
90 !
100 !DEFINE SEF
110 DFA"MKMX;MKCTR"
120 LBLA"SIGNAL TRACK"
130 !
140 END

```

Line No.	Description
20	Define and assign the max hold function as User Math A
30	Name this function 'MAX'
40	Set the unit to 'DB'
70	Define User Defined Function 1 to get the -3 dB Bandwidth
80	Label the softkey for UDF 1 as '-3DB BANDWIDTH'
110	Define and assign the signal tracking function to Sweep End Function A
120	Label the softkey for SEF A as 'SIGNAL TRACK'

6-5. HP-IB

The 4195A can be used as a component in a high performance HP-IB system with other instruments, desktop computers, and minicomputers to form an automated measurement system. HP-IB is Hewlett-Packard's implementation of IEEE 488-1978, Digital Interface for Programmable Instrumentation.

6-5-1. 4195A's HP-IB CAPABILITY

Table 6-6 lists the 4195A's IEEE Standard 488-1978, HP-IB capabilities and functions. These functions provide the means for an instrument to receive, process and transmit, commands, data, and status over the HP-IB bus.

Table 6-6. HP-IB Interface Capability

Code	Function
SH 1	Complete Source Handshake capability
AH 1	Complete Acceptor Handshake capability
T 5	Basic Talker; serial poll; unaddressed if MLA; Talk-Only
L 4	Basic Listener; unaddressed if MTA; no Listen-Only
SR 1	Complete Service Request capability
RL 1	Complete Remote/Local capability
DC 1	Complete Device Clear capability
DT 1	Complete Device Trigger capability
C 0	No Controller capability
E 1	Drivers are open-collector

NOTE

The 4195A does not have parallel polling capability.

6-5-2. HP-IB DEFINITION

The 4195A can be defined as Addressable, or Talk-Only.

1. Addressable Mode

In the addressable mode, the 4195A is set to a Listener or a Talker, and the 4195A's operation is controlled by an external controller. The address is selectable between 0 and 30. The default address is 17.

To set the 4195A to the addressable mode, press the **MORE** key, **'HP-IB define'** softkey and the **'ADDRESSABLE'** softkey (or enter the "HADM1" command from the Keyboard Input Line).

The HP-IB address is set using the **'HP-IB address'** softkey (or the "ADRS=" command). The procedure for setting the HP-IB address is shown next.

1. Press the **MORE** key in the SPECIAL FUNCTION area, and the **'HP-IB define'** softkey.
2. Press the **'HP-IB address'** softkey. The current address will be displayed on the Keyboard Input Line, as follows.

ADRS= 17

NOTE

The HP-IB address is stored in battery back up memory. If you have stored 20 as the HP-IB address, the displayed number will be 20 not 17.

3. Type the new address using the keys in the ENTRY area to change the address.
4. Press the **ENTER/EXECUTE** key.

2. Talk-Only Mode

The 4195A must be set to the Talk-only mode when it is connected to a Listen-Only device.

To set the 4195A to the Talk-Only mode, press the **MORE** key, **'HP-IB define'** softkey and the **'TALK only'** softkey (or enter the "HADM2" command from the Keyboard Input Line or from a User Program).

6-5-3. 4195A'S HP-IB COMMANDS

The 4195A HP-IB commands used to control the 4195A from an external controller are introduced here. These HP-IB commands are categorized as HP-IB Bus Commands, 4195A Query Commands, and 4195A Device Dependent Commands.

1. HP-IB Bus Commands

HP-IB bus commands have the same meaning in all HP-IB systems. The bus commands used by the 4195A are described here. HP BASIC statements are used in the description of the command examples. The three letter command abbreviations used in the IEEE 488-1978 nomenclature are shown in parentheses following each statement. Here, it is assumed that the 4195A's HP-IB address is 717.

ABORT I/O (IFC):

ABORT I/O halts all bus activity and deselects the 4195A.

ABORT 7

CLEAR LOCKOUT/SET LOCAL:

CLEAR LOCKOUT/SET LOCAL releases devices on the bus from the lockout mode and returns them to local (front panel) control. The difference between **CLEAR LOCKOUT/SET LOCAL** and **LOCAL** is in the addressing method used.

LOCAL 7

DEVICE CLEAR (SDC or DCL):

This command is used with an address to clear a particular device (**SDC**: selected device clear) or used without an address (**DCL**: clears all devices). The 4195A initializes itself when it receives this command (but the memory is not cleared). It is good programming practice to perform initialization at the very start of the program.

CLEAR 7: clears all devices on port 7.

CLEAR 717: clears the instrument with address 17.

LOCAL (GTL):

LOCAL returns control of a listening device to front panel control.

LOCAL 717

LOCAL LOCKOUT (LLO):

LOCAL LOCKOUT disables the **LOCAL** key of all devices on the bus. After this command is sent you will be unable to operate the 4195A from the front panel. Execute the **LOCAL** command to undo **LOCAL LOCKOUT**.

LOCAL LOCKOUT 7

REMOTE:

REMOTE sets the 4195A to the remote mode. When this command is sent, the front panel with the exception of the **LCL** key will be disabled. If **LOCAL LOCKOUT** is asserted then the front panel **LCL** key will also be disabled.

REMOTE 7: sets all devices on port 7 to remote

REMOTE 717: sets the instrument with address 17 to remote.

SPOLL:

SPOLL is the SERIAL POLLING command used to place the status byte of the addressed instrument on the bus. The eight bits of the status byte can be masked off and read to determine the 4195A's operating state. See paragraph 6-5-7 for more information on the status byte.

SPOLL(717): the instrument with address 17 is serial polled.

SERVICE REQUEST:

The 4195A sends an **SRQ** (Service Request) control signal when it requires the controller to perform a task. **SRQ** can be thought of as an interrupt which informs the controller that information is ready to be transmitted, or that an error condition exists in the instrument. When the 4195A sends an **SRQ**, it also sets Bit 6 of the status byte. Bit 6 is the **RQS** (Request Service) bit, sometimes referred to as the "status bit" in connection with polling. When the 4195A is serially polled, it clears the **RQS** bit and the **SRQ** line, one of the five management control lines of the system interface. Any bit in the status byte can initiate an **SRQ**. The status byte may be masked by the user to determine which bits caused the 4195A to set the **SRQ** line. See paragraph 6-5-7, for more status byte information.

TRIGGER (GET):

This command may be sent to a selected listener on the HP-IB bus. The 4195A must be in the addressable mode, and the trigger mode must be set to the external trigger mode, before the trigger message is sent.

TRIGGER 7 : Trigger all devices on port 7

TRIGGER 717 : Trigger the instrument with address 17

NOTE

See the BASIC Interface Techniques manual supplied with the computer, for a full description of the HP-IB bus commands.

2. 4195A QUERY Commands

When a QUERY command is entered, data is output to the 4195A's output buffer. These commands can be entered using a User Defined Function, Sweep End Function, User Program, via HP-IB, and from the Keyboard Input Line.

STB?

Reads the status byte. When **STB?** is entered, the status byte will be read as a decimal number. If this command is entered via HP-IB when the status byte is '01011011', you will read '91'.. Refer to paragraph 6-5-6, for the details of the status byte.

REV?

Reads the 4195A's firmware revision number. When **REV?** is entered, the revision date code will be output via HP-IB in the following format.

yyzz

When **REV?** is entered from the Keyboard Input Line, the revision number is displayed on the System Message Line, in the following format.

Rev x.xx yy zz

where

x.xx: version number

yy: released date (year)

zz: released date (week)

ID?

ID? identifies a device connected on the HP-IB bus. When the 4195A receives this command, it outputs a message saying what it is. If **ID?** is entered from the Keyboard Input Line, the following message is displayed on the System Message Line.

HP4195A NETWORK/SPECTRUM_ANALYZER OPT000

ERR?

ERR? reads the error code of the existing error in the 4195A. When this command is entered, the error code will be read as a decimal number. If **ERR?** is entered from the Keyboard Input Line, the error code is displayed on the System Message Line. The error codes are listed in Appendix C.

DISP?

DISP? outputs the data displayed on the System Message Line by the '**DISP" "**' command.

CMT?

CMT? outputs the data displayed in the Comment Area by the '**CMT" "**' command.

(register)?

The **(register)?** commands; **R0?**, **MKR?**, **A?**, and etc., output the data in the selected register.

NOTE

When a **QUERY** command except for the "(register)?" command is entered, the data is output in the ASCII format. The output format of the data output by the "(register)?" command, is in the format selected by the "**FMT1**", "**FMT2**", or "**FMT3**" commands. The details of data output formats are described in paragraph 6-5-5.

3. 4195A Device Dependent Commands

The 4195A device dependent commands have meaning only to the 4195A and its functions. Device dependent commands are unique commands which corresponds to the softkeys or keys on an instruments front panel. The details of these commands are described in Sections 4 and 5. The 4195A device dependent commands are listed in Appendix E.

6-5-4. HOW TO OUTPUT REGISTER DATA

The 4195A offers three data output formats to transfer certain types of register data to the controller on the HP-IB bus. Each of the three data formats have a different data transfer rate. The 4195A is enabled to output register data, by receiving the Query Command (?) as follows.

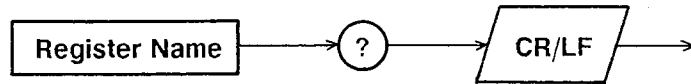
Syntax:**Examples:**

1. Single variable

OUTPUT 717; " R1? "**ENTER 717; R1**

2. Array variable

OUTPUT 717; " A? "**ENTER 717; A(*)**

6-5-5. DATA OUTPUT FORMATS

This paragraph describes the three 4195A data output formats; ASCII type, IEEE 64-bit binary type, and IEEE 32-bit binary type.

1. ASCII Type: FMT1

ASCII type (FMT1) is the default data output format. When FMT1 is active (**FMT1** command is entered), the 4195A transfers data in the ASCII format. Register data is represented in the following ASCII format.

a) Real Type (32-bit) Register Data

This data output format is used for registers which hold 32-bit floating point numbers. The syntax and the registers which use this data type are as follows.

SYNTAX:

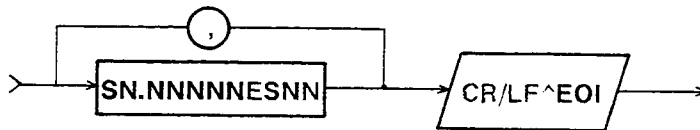

S: Sign
 N: Number
 E: Exponential Sign

REGISTER:

A	B	C	D	E	F	G	H	I	J
RA	RB	RC	RD	RE	RF				
MA	MB								
MFOR	MFOI	MFSR	MFSI	MFLR	MFLI	MFTR	MFTI	MFIR	MFII
MROR	MROI	MRSR	MRSI	MRLR	MRLI	MRTR	MRTI	MRIR	MRII
ZSG	ZSB	ZOR	ZOX						
TFOR	TFOI	TFSR	TFSI	TFLR	TFLI				
TROR	TROI	TRSR	TRSI	TRLR	TRLI				
MKRA	MKRB	DMKRA	DMKRB	SMKRA	SMKRB	LCURS	DLCURS		
EQVR	EQVL	EQVCA	EQVCB						
REF	DIV	BTM							
NVAL	SMTHR	SMTHX	SMTHL	SMTHC	RLOSS	VSWR			
PER1	PER2	PET1	PET2	PEP1	PEP2				

b) Real Type (64-bit) Register Data

This format is used for the registers that hold 64-bit floating point numbers.
(Leading zeros will be replaced by spaces.)

SYNTAX:

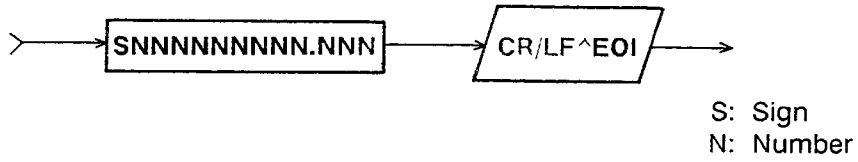

REGISTER:

OSC1	OSC2				
START	STOP	STEP	CENTER	SPAN	
MANUAL	FREQ	BIAS	DFREQ	X	
MKR	DMKR	SMKR	LCURSL	LCURSR	WID

NOTE

When the oscillator level unit is V, the data of these registers is transmitted as Real type (32-bit).

SYNTAX:

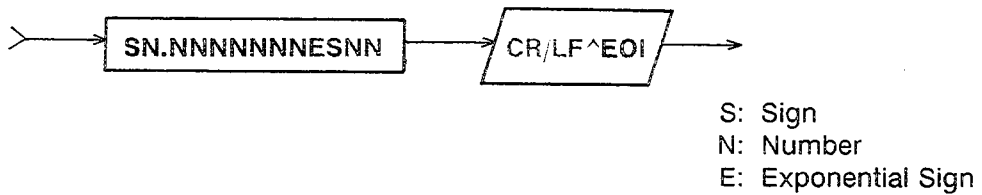

REGISTER:

Z	ST	RBW	QV	Rn (n= 0 to 99)
---	----	-----	----	-------------------

c) Integer Type Register Data

This format is used for the registers that hold 16-bit integer numbers. (Leading zeros will be replaced by spaces.)

SYNTAX:

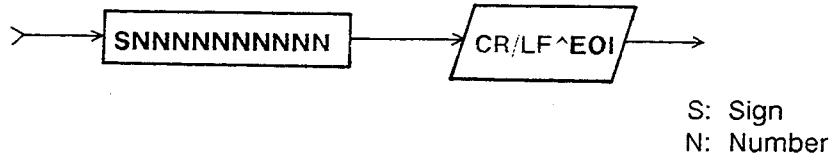

REGISTER:

NOP	ATR1	ATR2	ATT1	ATT2	ERR	PTN
-----	------	------	------	------	-----	-----

3. IEEE 32-BIT Binary Type: FMT3

This data type is the 32-bit floating point binary specified in the IEEE Standard 728-1982. This data type has the fastest data transfer rate. The syntax diagram and the data format for FMT3, are shown below. The 4195A does not output un-normalized data and '-0'.

SYNTAX:

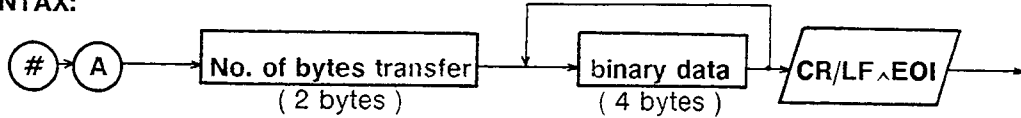

DATA FORMAT:

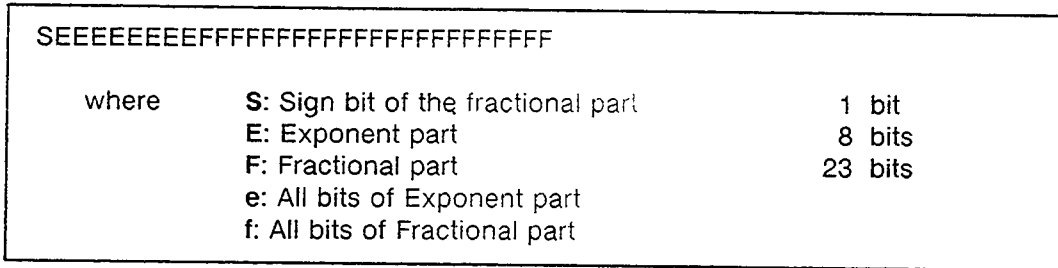

Real number (RN) can be defined as follows.

- 1) when $0 < e < 11111111$ (255)

$$RN = (-1)^S \times 2^{(e-127)} \times \{ 1 + f/(2^{23}) \}$$

- 2) when $S = 0, e = 0$ and $f = 0$

$$RN = 0 \text{ (zero)}$$

Example:

- a) If the sign bit (S) is 0, the exponent part (e) is 01111111 (127) , and the fractional part (f) is 0100000000000000000000 (2^{21}), the real number (RN) is +1.25.
- b) If $S=1, e= 10000000$ (128), and $f= 1000000000000000000000$ (2^{22}), then $RN= -3$.

6-5-6. DATA TRANSFER RATE

As previously stated, each data format has a different data transfer rate. Table 6-7 lists the typical data transfer rates when an array variable register consisting of 401 register elements is used.

Table 6-7. Data Transfer Rate

Code	Transfer Time with an HP 9000 series 300 computer	
	Using ENTER command	Using TRANSFER command
FMT1	700 msec	—
FMT2	120 msec	90 msec
FMT3	50 msec	40 msec

6-5-7. STATUS BYTE

A service request will be generated when any bit in the status byte is set. The status byte is an 8-bit status word that the 4195A places on the HP-IB bus when it is serially polled.

1. 4195A's Status Byte

The value of each bit indicates the status of an internal 4195A function. Bits are set to "1" and reset to "0". The bit assignments of the status byte are listed in Table 6-8.

Table 6-8. Status Byte Assignments

BIT	Value	Description
0(LSB)	0/1	End of Measurement (EOM)
1	0/1	End of Sweep (EOS)
2	0	Not used (always 0)
3	0/1	End Status
4	0/1	Trigger too Fast
5	0/1	Error Status
6	0/1	RQS (Request Service)
7(MSB)	0	Not used (always 0)

The definition of each bit is as follows:

BIT 0 (End of Measurement: EOM):

BIT 0 is set when a single point measurement (including compensation/ calibration measurement) is completed.

BIT 1 (End of Sweep: EOS):

This bit is set when a sweep measurement is completed (measurement of all points in the sweep range is complete). This includes compensation/ calibration measurements.

BIT 2 (Not used):

This bit is always 0 (zero).

BIT 3 (End Status):

This bit is set when the following operations are completed.

1. Copy
2. User Program (ASP) execution
3. Calibration/compensation

BIT 4 (Trigger too Fast):

This bit is set when the trigger command is sent under the following conditions.

1. The instrument is set to the **int** trigger mode.
2. The instrument is busy taking a measurement even in **ext** trigger mode.

BIT 5 (Error Status):

Bit 5 is set if any error is detected, including all HP-IB, hardware, and operation errors.

BIT 6 (Request Service: RQS):

This bit is set when the service request is granted, and is cleared when a serial-poll is performed. Bit 6 is non-maskable.

BIT 7 (Not used):

This bit is always 0 (zero).

NOTE

1. The status byte is cleared, reset to 0, when the 4195A receives the **CLS** command.
2. The status byte is cleared by the controller's serial polling, while BIT 6 (Request Service: RQS) of the status byte is set to 1.
3. The status byte can be read by sending an **STB?** query command. The **STB?** query command does not clear the status byte.

2. Masking the Status Byte

The "RQS" command is used to mask the status byte. The syntax of the "RQS" command is:

$$\text{RQS} = n \quad (n = 0 \text{ to } 255)$$

Where **n** is a decimal number corresponding to the mask bit pattern used to enable/disable bits of the status byte. For example, if **n** is equal to 34 (00100010), bits 1 and 5 are enabled, as follows.

RQS= 34 (00100010):

Bit No. of Status Byte	MSB							LSB
	7	6	5	4	3	2	1	0
Bit Pattern for RQS command	0	0	1	0	0	0	1	0

0= disable
1= enable

In this example, when a bit in the status byte is set, in this case either bit 1 or 5, a service request is generated. The default value of **RQS** is 0 (00000000: all bits disabled), no service request is generated.

Bit 6 (RQS) is non-maskable, and bits 2 and 7 are always 0, so masking these bits has no meaning. In other words, masking the status byte should be performed on the lower 6 bits (except for bit 2). All masking combinations can be covered by using a mask pattern between 0 and 63 for the value of **n** in the command **RQS= n**.

6-5-8. SENDING CHARACTERS BY HP-IB

To output a character string to an external device connected to the HP-IB bus, use the 4195A Device Dependent **"SEND"** command. The syntax of this statement is:

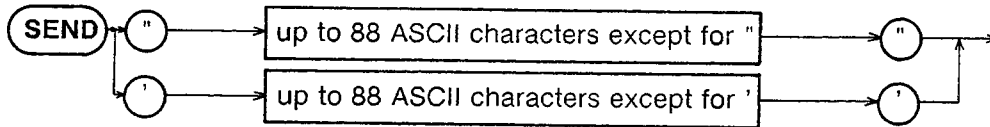

By entering this command to the 4195A, the characters between the two ' " (double quotation) ' marks are transmitted on the bus. The 4195A must be configured as a TALKER, and externally connected devices are configured as LISTENERS.

NOTE

The "SEND" statement can be used in a multi-statement.

6-5-9. HP-IB INTERFACE RESTRICTIONS

The following restrictions must be adhered to when using an HP-IB interface.

- The total length of cable in one bus system must be less than or equal to two meters times the number of devices connected on the bus (the HP-IB controller counts as one device) and the total length of cable must not exceed 20 meters.
- The maximum number of devices that may be connected on one bus system is 15.
- There are no restrictions on how the cables are connected together. However, it is recommended that no more than four piggyback connectors be stacked together on one device. The resulting structure could exert enough force on the connector mounting to damage it.

For example, a system containing six devices can be connected together with cables that have a total length of less than or equal to 12 meters (six devices \times 2m/device = 12 meters). The individual length of cable may be distributed in any manner desired as long as the total length does not exceed the allowed maximum. If more than ten devices are to be connected together, cables shorter than two meters must be used between some of the devices to keep the total cable length less than 20 meters.

Figure 6-3 shows the interconnection of a typical HP-IB system. The HP-IB connector is firmly fastened using two bolts to keep it from working loose during use. Figure 6-4 shows an HP-IB interface connector. The 4195A uses all of the available HP-IB lines; therefore, damage to any connector pin will adversely affect its HP-IB operation.

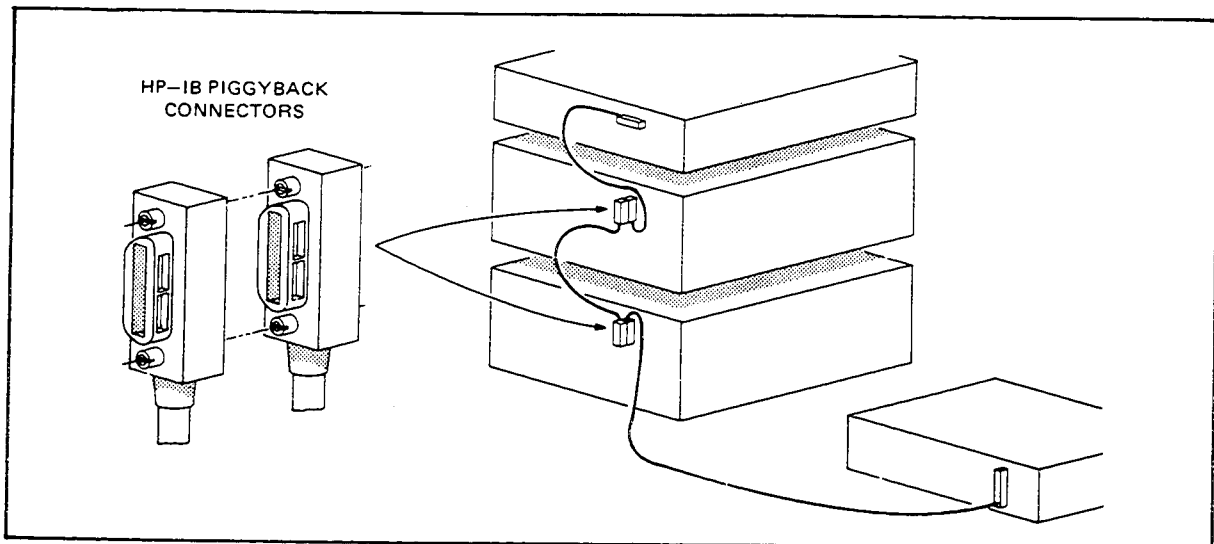

Figure 6-3. Typical HP-IB System Interconnection

CAUTION

THE 4195A CONTAINS METRIC THREADED HP-IB CABLE MOUNTING STUDS. THE METRIC VERSION OF THE HP 10833A, B, C, OR D HP-IB CABLE FASTENERS ARE DISTINGUISHED FROM THE ENGLISH VERSION BY COLOR. ENGLISH THREADED FASTENERS ARE SILVER; METRIC THREADED FASTENERS BLACK. DO NOT ATTEMPT TO MATE SILVER AND BLACK FASTENERS TO EACH OTHER. IF YOU DO, THE THREADS OF EITHER OR BOTH WILL BE DAMAGED.

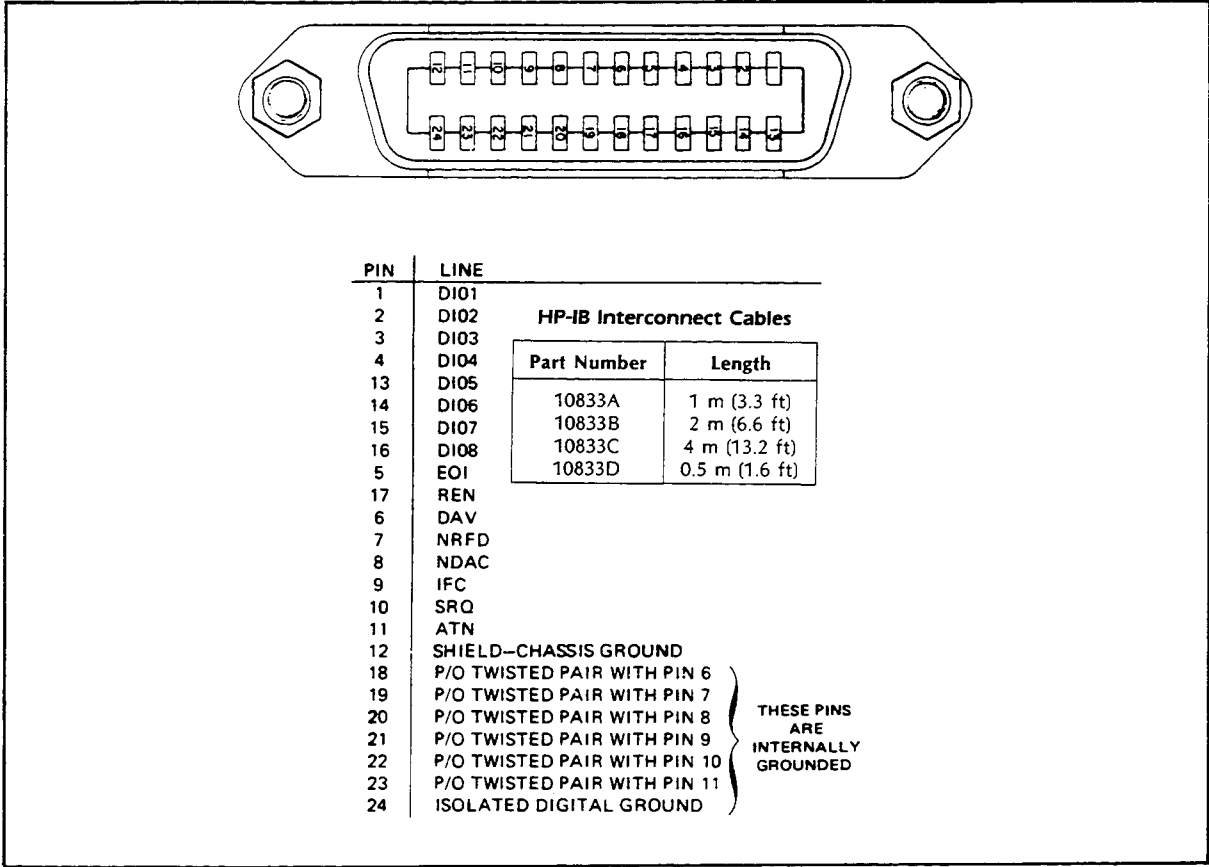

Figure 6-4. HP-IB interfacing

6-5-10. PROGRAM EXAMPLES

This paragraph introduces program examples for controlling the 4195A via HP-IB, with an HP 9000 Series 300 computer.

Example 1: Measurement Example using Network measurement function

Example 2: Data Transfer

- (1) Using ASCII format
- (2) Using Binary 64 bit format
- (3) Using Binary 32 bit format

Example 3: Hard Copy

- (1) Using Plot mode
- (2) Using Print mode
- (3) Using Dump mode

Example 4: Setting up a User Program

Example 5: Setting up a Programmed Points Table

NOTE

Before running the following programs, use the 'HP-IB address' softkey to set the 4195A's HP-IB address to 17.

Example 1: This program configures the system to measure the -3 dB Bandwidth of a 450 MHz Band-Pass Filter, and to print out the Insertion Loss, and the -3 dB Band Width.

Program Listing:

```

10      ! MEASUREMENT AND ANALYSIS EXAMPLE
20      !
30      Ads=717
40      REMOTE Ads
50      CLEAR Ads
60      !
70      Mask=2 ! Bit 1 enables SRQ interrupts.
80      Status_byte_rqs=2 ! Bit 1 enables End of sweep bit of 4195A.
90      !
100     !***** SET UP THE MEASUREMENT CONDITION *****
110     !
120     OUTPUT Ads;"FNC1"
130     OUTPUT Ads;"RST"
140     OUTPUT Ads;"RQS=";Status_byte_rqs
150     OUTPUT Ads;"CMT'";SWM2"
160     OUTPUT Ads;"PORT1;GPP1;DSP1"
170     OUTPUT Ads;"SWP1;CENTER=450MHZ;SPAN=20MHZ"
180     !
190     !***** TRIGGER *****
200     !
210     ON INTR 7 GOTO 250
220     OUTPUT Ads;"SWTR6"
230     ENABLE INTR 7;Mask
240     GOTO 240
250     OFF INTR 7
260     OUTPUT Ads;"CLS"
270     !
280     !***** ANALYSIS *****
290     !
300     OUTPUT Ads;"SCL2;AUTO;SCL1;AUTO"
310     OUTPUT Ads;"MCF4;MKMX;DLCURS=-3DB;DELT1;WIDTH1"
320     !
330     !***** INPUT DATA *****
340     !
350     OUTPUT Ads;"WID?"
360     ENTER Ads;Wid
370     OUTPUT Ads;"MKRA?"
380     ENTER Ads;I1
390     !
400     !***** DISPLAY THE DATA *****
410     !
420     PRINT "-3dB BAND WIDTH (Hz) =",Wid
430     PRINT "INSERTION LOSS (dB) =",I1
440     !
450     LOCAL Ads
460     END

```

Line Number	Description
70	MASK is used to enable the Service Request interrupts.
80	Status_byte_rqs is used to enable the 4195A's End of sweep bit.
120	Select the Network measurement function.
130	Initialize the 4195A for a Network measurement.
140	Enable bit 1 (EOS : End of Sweep bit) of the 4195A's status byte.
150	Clear the comment area, and select the Single sweep mode.
160	Select input port T1/R1, measurement parameter T/R(dB)- θ , and Rectangular X-A&B display format.
170	Set the measurement range (sweep range).
210 - 250	Trigger the sweep measurement, and wait until it is completed (until a service request from the 4195A is generated).
260	Clear the 4195A's status byte.
300	Auto scale the data displayed on the 4195A's screen.
310	Select the "o&LCRS mode", moves the o marker to a maximum point, and move the Line Cursor to the position 3 dB less than the o marker's position.
350 - 380	Store the -3 dB Bandwidth in variable <i>Wid</i> , and the insertion loss in variable <i>Il</i> .
420 - 430	Print the -3 dB Bandwidth and the Insertion Loss.

Example 2: The 4195A has three data output formats; FMT1, FMT2, and FMT3 (refer to paragraph 6-5-5). A program example will be given for each of these formats. In the FMT2 format (binary 64-bit data output), the measurement data is contained in the lower 8-bytes of the 12 data bytes transmitted by the 4195A. In the FMT3 format (binary 32-bit data output), the measurement data is contained in the lower 4-bytes of the 8 data bytes transmitted by the 4195A. The following programs use only the lower 8 or 4 data bytes.

(1) ASCII format (FMT1)

Program Listing:

```

10      ! DATA TRANSFER WHEN USING THE ASCII FORMAT (FMT1)
20      !
30      OPTION BASE 1
40      DIM A(401)
50      Ads=717
60      REMOTE Ads
70      !
80      OUTPUT Ads;"FMT1;A?"
90      ENTER Ads;A(*)
100     !
110     FOR I=1 TO 401
120     PRINT "A(";I;" )=" ,A(I)
130     NEXT I
140     !
150     LOCAL Ads
160     END

```

Line Number	Description
80	Select the ASCII format, and transmit data in the A register through the output buffer of the 4195A.
90	Store the data sent from the 4195A, in variable A.
110 - 130	Print variable A.

(2) Binary 64-bit format (FMT2)

Program Listing:

```

10    ! DATA TRANSFER WHEN USING THE BINARY 64 BIT FORMAT (FMT2)
20    !
30    OPTION BASE 1
40    DIM Junk$[4]
50    REAL A(401)
60    !
70    ASSIGN @Ads TO 717;FORMAT ON
80    REMOTE @Ads
90    !
100   OUTPUT @Ads;"FMT2;A?"
110   ENTER @Ads USING "#,4A";Junk$
120   ASSIGN @Ads;FORMAT OFF
130   ENTER @Ads;A(*)
140   !
150   FOR I=1 TO 401
160   PRINT "A(";I;")=" ,A(I)
170   NEXT I
180   !
190   LOCAL @Ads
200   END

```

Line Number	Description
70	Set the I/O path between the controller and the 4195A with the FORMAT ON attribute, the 4195A can only receive data in the ASCII format.
100	Select the Binary 64-bit data output format, and output data in the A register through the 4195A's output buffer.
110	Store the upper 4-bytes of the data sent from the 4195A, in Junk\$. This data is not measurement data, so it is not used.
120	Set the I/O path between the controller and the 4195A to the FORMAT OFF attribute, the binary 64-bit data format is the same data format used by HP 9000 series 300 computers.
130	Store the lower 8-bytes of data in variable A. The lower 8-bytes of data A are binary 64-bit data.
150 - 170	Print variable A.

(3) Binary 32-bit format (FMT3)

Program Listing:

```

10  |(3) DATA TRANSFER WHEN USING THE BINARY 32 BIT (FMT3)
20  |
30  OPTION BASE 1
40  INTEGER A(802),Upper,Lower,I
50  REAL Aa(401)
60  DIM Junk$(4)
70  ASSIGN @Ads TO 717;FORMAT ON
80  REMOTE @Ads
90  !
100 OUTPUT @Ads;"FMT3;A?"
110 ENTER @Ads USING "#,4A";Junk$
120 ASSIGN @Ads;FORMAT OFF
130 ENTER @Ads;A(*)
140 !
150 FOR I=1 TO 401
160   Upper=A(I*2-1)
170   Lower=A(I*2)
180   IF Upper=0 AND Lower=0 THEN
190     Aa(I)=0
200   ELSE
210     Exp=SHIFT(SHIFT(Upper,-1),8)
220     Tem=SHIFT(SHIFT(Upper,-9),9)
230     Low=Lower
240     IF Lower<0 THEN Low=65536+Lower
250     Man=Tem*2^16+Low
260     Aa(I)=DROUND(SGN(Upper)*(2^(Exp-127)+Man*2^(Exp-150)),6)
270   END IF
280   PRINT "A(";I;")=";Aa(I)
290 NEXT I
300 !
310 LOCAL @Ads
320 END

```

Line Number	Description
70	Set the I/O path between the controller and the 4195A with the FORMAT ON attribute, the 4195A can only receive data in the ASCII format.
100	Select the Binary 32-bit data output format, and move the data the A register to the 4195A's output buffer.
110	Store the upper 4-bytes of the data sent from the 4195A in Junk\$. This data is not measurement data, so it is not used.
120	Set the I/O path between the controller and the 4195A to the FORMAT OFF attribute, this data is not in the ASCII format.

Line Number	Description
130	Store the lower 4-bytes sent from the 4195A in variable A (INTEGER). The lower 4 bytes are Binary 32-bit data. This data is entered every 2 bytes.
160 - 170	Store the upper 2-bytes of the binary 32-bit data in variable Upper , and the lower 2-bytes in variable Lower .
180 - 190	If Upper = 0 and Lower = 0, store 0 (zero) in variable Aa .
210 - 250	If Upper ≠ 0 or Lower ≠ 0, store the exponent part in Upper in variable Exp , the fractional part in Upper in variable Tem , and the fractional part in Lower in variable Low . Store the complete fractional part in variable Man .
260	Store the arranged data in variable Aa . The equation used to arrange the data, is described in paragraph 6-5-5.
280	Print variable Aa .

Example 3: The 4195A can plot, print, or dump the measurement data without an external controller (refer to paragraph 5-13). The following tells how to plot, print, and dump measurement data, via HP-IB.

(1) Plot (CPYM1)

Program Listing:

```

10    ! COPY DISPLAY BY "PLOT MODE" (CPYM1)
20    !
30    !***** INITIAL SETTING *****
40    !
50    INTEGER Select_code,Ads_4195a,Ads_plotter,Hp_4195a
60    Select_code=7
70    Ads_4195a=17
80    Ads_plotter=5
90    Hp_4195a=Select_code*100+Ads_4195a
100   !
110   Mask=2           ! Bit 1 enables SRQ interrupts.
120   Status_byte=8   ! Bit 3 enables End bit of 4195A.
130   !
140   ! (( PLOT AREA ))
150   !
160   P1x=2000        ! P1x is left of plot area
170   P1y=800         ! P1y is bottom of plot area
180   P2x=9200        ! P2x is right of plot area
190   P2y=7200        ! P2y is top of plot area
200   !               ( where 1 count is 0.025 mm )
210   !
220   REMOTE Hp_4195a
230   OUTPUT Hp_4195a;"RQS=";Status_byte
240   !
250   !***** PLOT GRATICULE *****
250   !
270   ON INTR Select_code GOTO End_plot
280   !
290   OUTPUT Hp_4195a;"CPYM1"
300   OUTPUT Hp_4195a;"PLTF1;SCLP1"
310   OUTPUT Hp_4195a;"PSCALE=";P1x;" ";P1y;" ";P2x;" ";P2y
320   OUTPUT Hp_4195a;"SENDPS"
330   SEND Select_code;UNL TALK Ads_4195a LISTEN Ads_plotter DATA
340   WAIT .5
350   OUTPUT Hp_4195a;"COPY"
360   SEND Select_code;UNL TALK Ads_4195a LISTEN Ads_plotter DATA
370   !
380   ENABLE INTR Select_code;Mask
390   DISP "WAITING FOR PLOT"
400   GOTO 400
410   !
420 End_plot: !
430   OFF INTR Select_code
440   OUTPUT Hp_4195a;"CLS"
450   DISP "PLOT COMPLETED"
460   END

```

Line Number	Description
70 - 90	Set the HP-IB addresses of the peripherals.
110	Mask is used to enable the Service Request interrupts.
120	Status_byte is used to mask the 4195A's status byte.
230	Bit 3 (END bit) of the 4195A's status byte is enabled.
290 - 320	Selects the 'plot mode', 'plot all', 'P1 P2 normal', and sets the plot area. Plot scale data is put in the 4195A's output buffer.
330	Configure the 4195A as a Talker, and the plotter as a Listener. Transmit plot scale data from the 4195A to the plotter.
340	Wait until the plot scale data is received by the plotter.
350	Send the " COPY " command to the 4195A. The 4195A outputs the data through its output buffer.
360	Configure the 4195A as a talker, and the plotter as a Listener. Transmit the data from the 4195A to the plotter.
380 - 400	Wait until the copy is completed (a service request from the 4195A is generated).
440	Clear the 4195A's status byte.

(2) Print (CPYM2)

Program Listing:

```

10      | COPY MEASURED DATA BY "PRINT MODE" (CPYM2)
20      |
30      |***** INITIAL SETTING *****
40      |
50      INTEGER Select_code,Ads_4195a,Ads_prntr,Hp_4195a
60      Select_code=7
70      Ads_4195a=17
80      Ads_prntr=1
90      Hp_4195a=Select_code*100+Ads_4195a
100     |
110     Mask=2          ! Bit 1 enables SRQ interrupts.
120     Status_byte=8  ! Bit 3 enables End bit of 4195A.
130     |
140     REMOTE Hp_4195a
150     OUTPUT Hp_4195a;"RQS=";Status_byte
160     |
170     |***** PRINT DATA *****
180     |
190     ON INTR Select_code GOTO End_print
200     |
210     OUTPUT Hp_4195a;"CPYM2"
220     OUTPUT Hp_4195a;"COPY"
230     |
240     SEND Select_code;UNL TALK Ads_4195a LISTEN Ads_prntr DATA
250     ENABLE INTR Select_code;Mask
260     DISP "WAITING FOR PRINT"
270     GOTO 270
280     |
290 End_print:  !
300     OFF INTR Select_code
310     OUTPUT Hp_4195a;"CLS"
320     DISP "PRINT COMPLETED"
330     END

```

Line Number	Description
150	Enable bit 3 (END bit) of the 4195A's status byte.
210	Select the print mode.
220	Send the "COPY" command to the 4195A, the 4195A outputs the data through its output buffer.
240	Configure the 4195A as a Talker, and the printer as a Listener. Transmit the data from the 4195A to the printer.
250 - 270	Wait until the copy is completed (a service request from the 4195A is generated).
310	Clear the 4195A's status byte.

(3) Dump (CPYM3)

Program Listing:

```

10    ! COPY DISPLAY BY "DUMP MODE" (CPYM3)
20    !
30    !***** INITIAL SETTING *****
40    !
50    INTEGER Select_code,Ads_4195a,Ads_prntr,Hp_4195a
60    Select_code=7
70    Ads_4195a=17
80    Ads_prntr=1
90    Hp_4195a=Select_code*100+Ads_4195a
100   !
110   Mask=2          ! Bit 1 enables SRQ interrupts.
120   Status_byte=8  ! Bit 3 enables End bit of 4195A.
130   !
140   REMOTE Hp_4195a
150   OUTPUT Hp_4195a;"RQS=";Status_byte
160   !
170   !***** DUMP DISPLAY *****
180   !
190   ON INTR Select_code GOTO End_dump
200   !
210   OUTPUT Hp_4195a;"CPYM3"
220   OUTPUT Hp_4195a;"COPY"
230   !
240   SEND Select_code;UNL TALK Ads_4195a LISTEN Ads_prntr DATA
250   ENABLE INTR Select_code;Mask
260   DISP "WAITING FOR GRAPHICS DUMP"
270   GOTO 270
280   !
290 End_dump:  !
300   OFF INTR Select_code
310   OUTPUT Hp_4195a;"CLS"
320   DISP "GRAPHICS DUMP COMPLETED"
330   END

```

Line Number	Description
150	Enable bit 3 (END bit) of the 4195A's status byte.
210	Select the dump mode.
220	Send the "COPY" command to the 4195A, the 4195A puts the data in its output buffer.
240	Configure the 4195A as a Talker, and the printer as a Listener. Transmit the data from the 4195A to the printer.
250 - 270	Wait until the copy is completed (a service request from the 4195A is generated).
310	Clear the 4195A's status byte.

Example 4: This program sets up the User Program which is the User Program sample introduced in paragraph 6-4-9, Example 1.

Program Listing:

```

10      ! USER PROGRAM DOWNLOAD
20      !
30      Ads=717
40      REMOTE Ads
50      OUTPUT Ads;"SCRATCH"
60      !
70      OUTPUT Ads;"PROG""10 CMT'RIPPLE MEAS.'""
80      OUTPUT Ads;"PROG""20 FNC1""
90      OUTPUT Ads;"PROG""30 RST""
100     OUTPUT Ads;"PROG""40 GPP1;PORT1""
110     OUTPUT Ads;"PROG""50 CENTER=100MHZ;SPAN=500KHZ""
120     OUTPUT Ads;"PROG""60 SWTRG""
130     OUTPUT Ads;"PROG""70 MCF2;MKR=99990000;SMKR=100010000""
140     OUTPUT Ads;"PROG""80 ARSTR;ANA1""
150     OUTPUT Ads;"PROG""90 MKACTION;MKMX""
160     OUTPUT Ads;"PROG""100 MKACTION;MKMN""
170     OUTPUT Ads;"PROG""110 DELT1""
180     OUTPUT Ads;"PROG""120 R1=DMKRA""
190     OUTPUT Ads;"PROG""130 DISP'RIPPLE(DB)=' ,R1""
200     OUTPUT Ads;"PROG""140 END""
210     !
220     LOCAL Ads
230     BEEP
240     DISP "USER PROGRAM DOWNLOAD IS COMPLETE"
250     END

```

Line Number	Description
40	Set the 4195A to remote.
50	Clear the 4195A's ASP edit page.
70 - 200	Enter the User Program on the 4195A's ASP edit page, by using the "PROG" command.

Example 5: This program sets up a Programmed Points Table. The table set up in this example, is same as the table set up by the User Program in paragraph 6-4-9, Example 3.

Program Listing:

```

10  ! PROGRAMMED POINTS TABLE DOWNLOAD
20  !
30  Ads=717
40  REMOTE Ads
50  CLEAR Ads
60  !
70  OUTPUT Ads;"CPL1"
80  OUTPUT Ads;"PTN=1"
90  OUTPUT Ads;"PTCLR"
100 OUTPUT Ads;"PTSWP1"
110 !
120 Freq=190000000
130 !
140 FOR I=1 TO 401
150     OUTPUT Ads;"POINT=";Freq
160     IF I<101 OR I>300 THEN
170         Freq=Freq+80000
180         GOTO 220
190     ELSE
200         Freq=Freq+20000
210     END IF
220 NEXT I
230 !
240 LOCAL Ads
250 BEEP
260 DISP "PROGRAMMED POINTS TABLE DOWNLOAD IS COMPLETE"
270 END

```

Line Number	Description
70	Select the Couple mode to enter the RBW value to be coupled to the frequency (the Programmed Points Table must be set up with the sweep points, and the value of the Resolution Band Width).
80	Select Programmed Points Table number 1.
90	Clear table 1.
100	Set frequency sweep mode for Programmed Points Table 1.
150	Set the value indicated by Freq to the sweep point, by using the " POINT= " command.
160 - 180	If the number of points is less than 101, or greater than 300, add 80000 to Freq , and go to line 160.
190 - 210	If the number of points is between 101 and 300, add 20000 to Freq .

NOTES

SECTION 7

GENERAL INFORMATION

7-1. INTRODUCTION

This section describes specifications, supplemental performance characteristics, storage/repacking, and other general information about the HP 4195A.

7-2. COMPONENTS NOT COVERED BY WARRANTY

The flexible discs are not covered under the 4195A's warranty. If the flexible discs becomes defective even within the warranty period of the 4195A, the cost of the replacement flexible disc must be paid for by the user.

7-3. SAFETY CONSIDERATIONS

The 4195A conforms to the safety requirements of the IEC (International Electromechanical Committee) Safety Class 1 instrument, and is shipped from the factory in a safe condition.

7-4. SERIAL NUMBER

Hewlett-Packard uses a two-part, nine character serial number stamped on the serial number plate (see Figure 7-1) attached to the instrument's rear-panel. The first four digits and the letter are the serial prefix, and the last five digits are the suffix. The letter placed between the two sections identifies the country where the instrument was manufactured. The prefix is the same for all identical instruments; it changes only when a change is made to the instrument. The suffix, however, is assigned sequentially and is different for each instrument. The contents of this manual apply to instruments with the serial number prefixes listed under Serial Numbers on the title page.

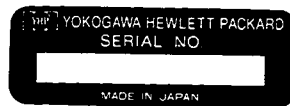

Figure 7-1. Serial Number Plate

An instrument manufactured after the printing of this manual may have a serial number prefix that is not listed on the title page. This unlisted serial number prefix indicates the instrument is different from those described in this manual. The manual for this new instrument may be accompanied by a yellow Manual Changes supplement or have a different manual part number. This supplement contains "change information" that explains how to adapt the manual to the newer instrument.

In addition to change information, the supplement may contain information for correcting errors (Errata) in the manual. To keep this manual as current and accurate as possible, Hewlett-Packard recommends that you periodically request the latest Manual Changes supplement. The supplement for this manual is identified with this manual's print date and part number, both of which appear on the manual's title page. Complimentary copies of the supplement are available from Hewlett-Packard. If the serial prefix or number of an instrument is lower than that on the title page of this manual, see APPENDIX A, MANUAL CHANGE.

For information concerning a serial number prefix that is not listed on the title page or in the Manual change supplement, contact the nearest Hewlett-Packard office.

7-5. SPECIFICATIONS

Table 7-1 lists the complete specifications for the HP 4195A. These specifications are the performance standards or limits against which the 4195A is tested. Table 7-1 includes supplemental characteristics which are not specified in the specifications. The supplemental characteristics are included as additional information for the operator. To distinguish the specification from the supplemental characteristics, 'Typical', 'Nominal', or 'Approximately' are attached to the supplemental characteristics. When shipped from the factory, the 4195A meets the specifications listed in Table 7-1. The specification test procedures are covered in the Performance Test in the Maintenance Manual.

The 4195A has the Options as listed in Table 7-2. Options are modifications to the standard instrument that implement the user's special requirements for minor functional changes.

Table 7-3 lists the furnished accessories which are shown in Figure 1-1. The accessories available for the 4195A are listed in Table 7-4. Table 7-5 shows the accessory selection guide.

7-6. RACK/HANDLE INSTALLATION

This paragraph describes the installation procedure for the Front Handle Kit (Option 907), the Rack Flange Kit (Option 908) and the Rack & Handle Kit (Option 909). Figure 7-2 shows the installation location for the parts, and the part number of these kits.

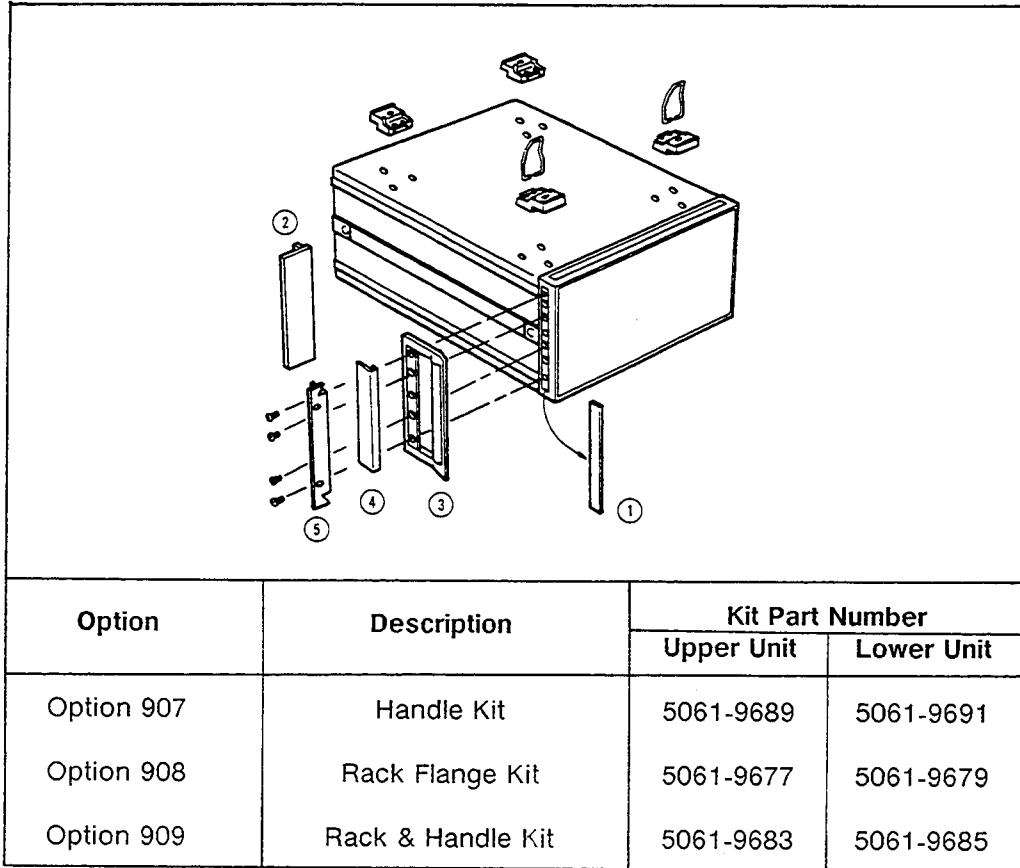

Figure 7-2. Rack Mount Kits

7-6-1. FRONT HANDLE KIT

This kit is installed to facilitate instrument handling on the bench, due to the 4195A's weight (41 Kg).

PROCEDURE:

1. Remove the adhesive-backed trim strip (1) from both sides of the front panel frame for the both units (Control Unit, and Measurement Unit).
2. Attach the handles (3) to both sides of the front panel frame with the screws provided, and attach the trim (4).

7-6-2. RACK FLANGE KIT AND RACK & HANDLE KIT

The Rack Flange Kit is required to rack-mount the 4195A in a cabinet. The Rack & Handle Kit are used to rack-mount the 4195A in a cabinet, with a handle.

PROCEDURE:

1. Remove the Rear Panel Lock Foot Kit, or the four feet of the Control Unit, and the four feet of the Measurement Unit (refer to paragraph 1-3).
2. Remove the adhesive-backed trim strip (1) from both sides of the front panel frame.
3. a) For Rack Flange Kit
Attach the rack mount flange (2) to both sides of the front panel frame with the screws provided.
- b) For Rack & Handle Kit
Attach front handle (3) and rack mount flange (5) to both sides of the front panel frame with screws provided.
4. Install an instrument support rail on each side of the instrument rack. The instrument support rails, used to support the weight of the instrument, are included with HP rack-mount cabinets.

WARNING

THE WEIGHT OF THE 4195A MUST BE SUPPORTED BY INSTRUMENT SUPPORT RAILS INSIDE THE INSTRUMENT RACK. DO NOT, UNDER ANY CIRCUMSTANCES, ATTEMPT TO RACK-MOUNT THE HP 4195A USING ONLY THE FRONT FLANGES.

THE 4195A'S CONTROL UNIT IS HEAVY (APPROXIMATELY 25 kg.). USE EXTREME CARE WHEN LIFTING IT.

5. Two people should lift the 4195A to its position in the rack on top of the instrument support rails.
6. Use the appropriate fasteners to fasten the 4195A's Rack-Mount Flanges to front of the rack-mount cabinets.

7-7. BOTTOM FEET/TILT STAND

How To Remove The Bottom Foot

The 4195A has feet attached to the bottom cover of each unit when it is shipped from the factory. The bottom feet must be removed, when connecting the control unit and the measurement unit of the 4195A, or rack-mounting the 4195A.

1. Lift the tab of the bottom foot.
2. Slide the bottom foot in the direction of the tab.

How To Use The Tilt Stand

The front of the 4195A can be lifted by using the tilt stand.

1. Lift the front of the 4195A.
2. Pull the tilt stands down into the down locked position.

WARNING

THE 4195A IS HEAVY (APPROXIMATELY 41 kg). USE EXTREME CARE WHEN LIFTING IT.

7-8. STORAGE/REPACKING

This paragraph describes the environment for storing or shipping the 4195A, and how to repackage the 4195A for shipment when necessary.

7-8-1. ENVIRONMENT

The 4195A should be stored in a clean, dry environment. The following environmental limitations apply for both storage and shipment.

Temperature:	-40°C to 70°C
Humidity:	≤95% RH (@ 40°C)

To prevent condensation from taking place inside of the 4195A, protect the instrument against temperature extremes.

CAUTION

When storing or moving the 4195A, be sure micro flexible disc is not in the disc drive. (Inserting the protective plastic dummy disc is recommended.)

7-8-2. ORIGINAL PACKAGING

Containers and materials identical to those used in factory packaging are available from Hewlett-Packard offices. If the instrument is being returned to Hewlett-Packard for servicing, attach a tag indicating the service required, the return address, the model number, and the full serial number. Mark the container **FRAGILE** to ensure careful handling. In any correspondence, refer to the instrument by model number and its full serial number.

7-8-3. OTHER PACKAGING

The following general instructions should be used when repacking with commercially available materials:

1. Wrap the 4195A in heavy paper or plastic. If shipping to a Hewlett-Packard sales office or service center, attach a tag indicating the service required, return address, model number, and the full serial number.
2. Use a strong shipping container. A double-walled carton made of at least 350 pound test material is required.
3. Use enough shock absorbing material (a 3 to 4 inch layer) around all sides of the 4195A to provide a firm cushion, and to prevent movement of the 4195A inside of the container. Protect the front-panel using cardboard.
4. Seal the shipping container securely.
5. Mark the shipping container **FRAGILE** to help ensure careful handling.
6. In any correspondence, refer to 4195A by model number and full serial number.

CAUTION

Before packing the 4195A for shipment, the Rear Panel Lock Foot Kit, which secures the control unit to the measurement unit, must be removed. The units must be packaged separately to prevent damage during transit.

NOTE

When returning the 4195A to the HP service office, return both units: Control unit (upper unit), and Measurement unit (lower unit).

Table 7-1. Specifications (1 of 15)

These specifications describe the instrument's warranted performance over the temperature range of 0 to 55 °C (except where noted). The supplemental characteristics are intended to provide information useful in applying the instrument, these parameters are non-warranted performance parameters. These are denoted as "typical", "nominal", or "approximate".

--- GENERAL ---

OPERATING ENVIRONMENT:	Temperature: 0 °C to 55 °C Humidity: ≤95% RH (at 40 °C)
STORAGE TEMPERATURE:	-40 °C to 70 °C
SAFETY:	Based on IEC-348, ANSI-C-39.5
EMI:	Based on FTZ-526/527
POWER REQUIREMENTS:	100, 120, 220 V ±10%, 240 V -10% +5%, 48 Hz to 66 Hz, 500 VA (max)
DIMENSIONS:	Approximately 425(W) × 375(H) × 620(D) (mm)
WEIGHT:	Approximately 41 kg
EXTERNAL TRIGGER:	Rear Panel BNC(f), TTL level
USER PROGRAM TRIGGER:	Rear Panel BNC(f), TTL level
EXTERNAL STANDARD FREQUENCY INPUT (EXT REFERENCE connector):	
Frequency:	10/N MHz, ≤10 ppm (N is integer from 1 to 10)
Level:	-5 to +5 dBm (Typical)
Input Impedance:	Approximately 50Ω
Connector:	BNC(f)
STANDARD FREQUENCY OUTPUT:	
10 MHz OUTPUT connector:	
Frequency:	10 MHz, ±20 ppm at 23 ±5 °C
Level:	Typical 0 dBm
Connector:	BNC(f)
REFERENCE OVEN connector: (Option 001 only)	
Frequency:	10 MHz, ±1 ppm at 23 ±5 °C
Level:	Typical 2 dBm
Connector:	BNC(f)
8 BIT INPUT/OUTPUT:	D-SUB connector (25 pin), TTL level

Table 7-1. Specifications (2 of 15)

--- BASIC SPECIFICATIONS ---

NETWORK MEASUREMENT

SOURCE:

Frequency:

- Range: 10 Hz to 500 MHz
- Resolution: 1 mHz
- Accuracy: ± 20 ppm (23 ± 5 °C)
 ± 1 ppm (23 ± 5 °C; with Option 001)
- Stability: $\pm 5 \times 10^{-6}$ /day (23 ± 5 °C; Typical)
 $\pm 1 \times 10^{-8}$ /day (23 ± 5 °C; with Option 001)

Output:

- Range: -50 to +15 dBm at 50 Ω
- Resolution: 0.1 dB
- Unit: dBm, dB μ V, Vrms
- Level Accuracy:
 - Accuracy: ± 0.5 dB at +10 dBm, 50 MHz (23 ± 5 °C)
 - Linearity: ± 0.5 dB at -35 to +10 dBm
 - Flatness: ± 1.5 dB
- Impedance: Nominal 50 Ω
Return Loss (Typical):
 - ≥ 15 dB (at $\leq +5$ dBm)
 - ≥ 10 dB (at $> +5$ dBm)
- Connector: Type-N(f) connector
- Spectral Purity:
 - Harmonics: < -30 dBc at 10 dBm
 - Non-Harmonic Spurious: < -50 dBc at 10 dBm
 - Phase Noise: < -100 dBc/Hz at 20 kHz offset, SPAN ≤ 2.4 MHz

Sweep:

- Sweep Parameter: Frequency, Power, and DC Bias Voltage
- Power Sweep Range: Max. 26 dB at -50 to +15 dBm
- Power Sweep Linearity: ± 0.2 dB/10 dB at -50 dBm to +10 dBm
- Sweep Type:
 - Linear, Log, CW, Programmed Points, and Partial Sweeps the points set to the programmed points table. The sweep points, and resolution band width can be set.
 - Partial Sweep: Sweeps one part of the sweep range.
- Sweep Mode: Continuous, Single, Manual
- Trigger Mode: Internal, External, Manual
- Number of Measurement Points: 2 to 401 points

Table 7-1. Specifications (3 of 15)

- Sweep Time: Depends on RBW and sweep time.

RBW	Measurement Time/point
30 kHz	approximately 3 msec
3 kHz	approximately 5.3 msec
300 Hz	approximately 36 msec
30 Hz	approximately 254 msec

DC Bias Level:

- Range: -40 to +40 V (Max. 20 mA)
- Resolution: 10 mV
- Accuracy: $\pm(0.12\% + 5 \text{ mV})$ at $23 \pm 5^\circ\text{C}$

RECEIVER:

Input:

- Frequency Range: 10 Hz to 500 MHz
- Inputs: 4 Inputs (R1, T1, R2, T2)
- Connector: Type-N(f) connector
- Resolution Band Width: 3 Hz to 300 kHz, 1, 3, 10 steps
- Impedance: Nominal 50Ω
Return Loss $\geq 15 \text{ dB}$
- Attenuator: 0 to 50 dB, 10 dB step (for all Inputs)
- IF Range: Normal mode or High Sensitivity mode is selectable.
High Sensitivity mode is effective at the low level signal measurement.
- Input Range: Input range is changed by the Attenuator and IF range, as follows. The value of Input Range is displayed on the System Message Line.

Attenuator	IF Range	
	Normal mode	High Sensitivity mode
0 dB	-10 dBm	-20 dBm
10 dB	0 dBm	-10 dBm
20 dB	10 dBm	0 dBm
30 dB	20 dBm	10 dBm
40 dB	20 dBm	20 dBm
50 dB	20 dBm	20 dBm

- Maximum Input Level: +20 dBm at 50Ω
- Damage Level: +30 dBm or $\pm 7 \text{ VDC}$ (Typical)
- Input Cross Talk: $< -100 \text{ dB}$ at $\leq 400 \text{ MHz}$
 $< -90 \text{ dB}$ at $> 400 \text{ MHz}$

Table 7-1. Specifications (4 of 15)

Magnitude Ratio (T/R):

- Dynamic Range: ≥ 100 dB
- Resolution: 0.001 dB
- Dynamic Accuracy (at $23 \pm 5^\circ\text{C}$):

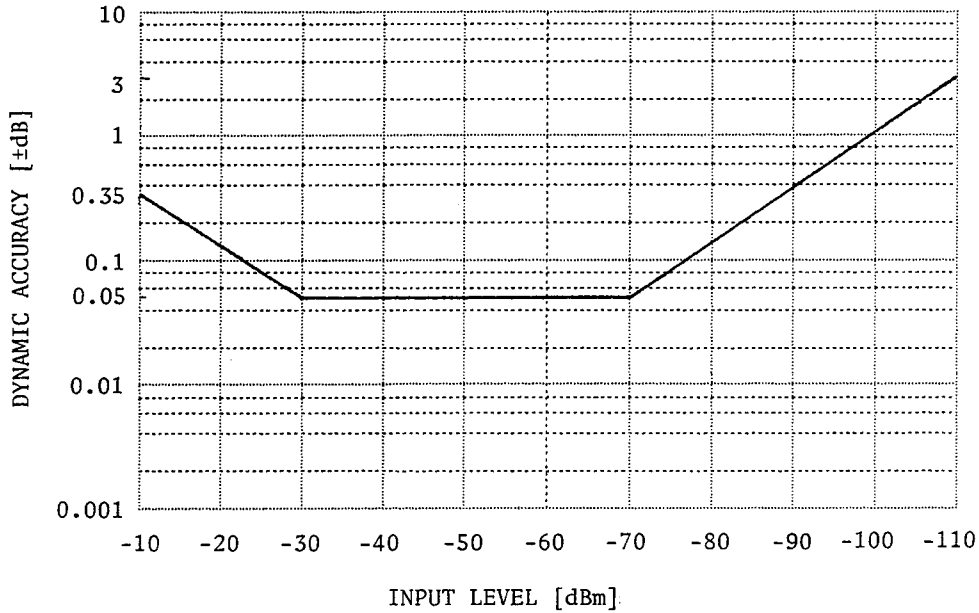

Where: IF range: Normal mode
 Attenuators: 0 dB
 Reference Input Level: -30 dBm
 Resolution Band Width: 10 Hz

- Frequency Response: (The frequency response error can be reduced by NORMALIZE.)

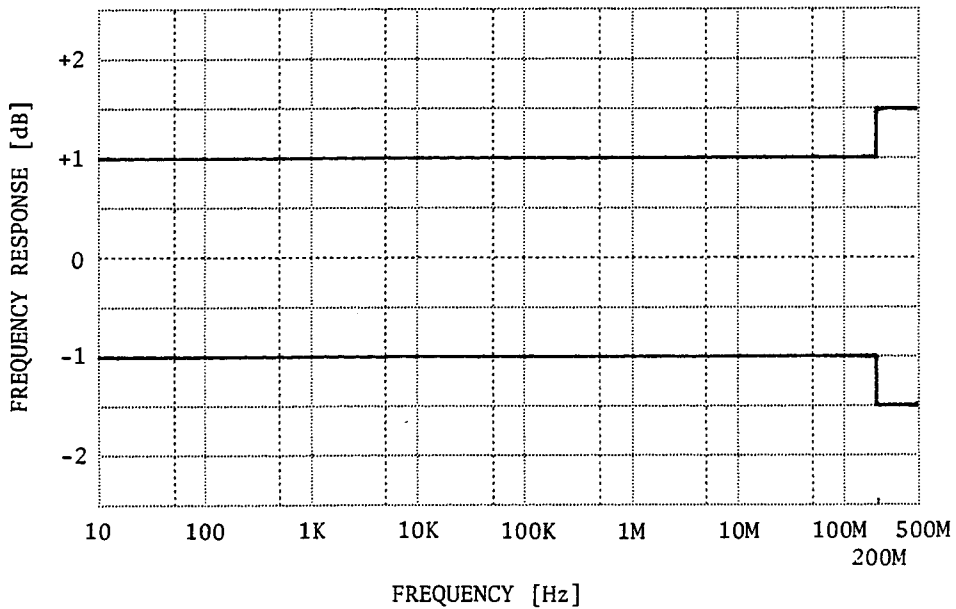

Where, the Input Attenuators for two inputs must be the same value, respectively.

Table 7-1. Specifications (5 of 15)

Phase:

- Range: ± 180 deg
- Resolution: 0.01 deg
- Dynamic Accuracy (at $23 \pm 5^\circ\text{C}$):

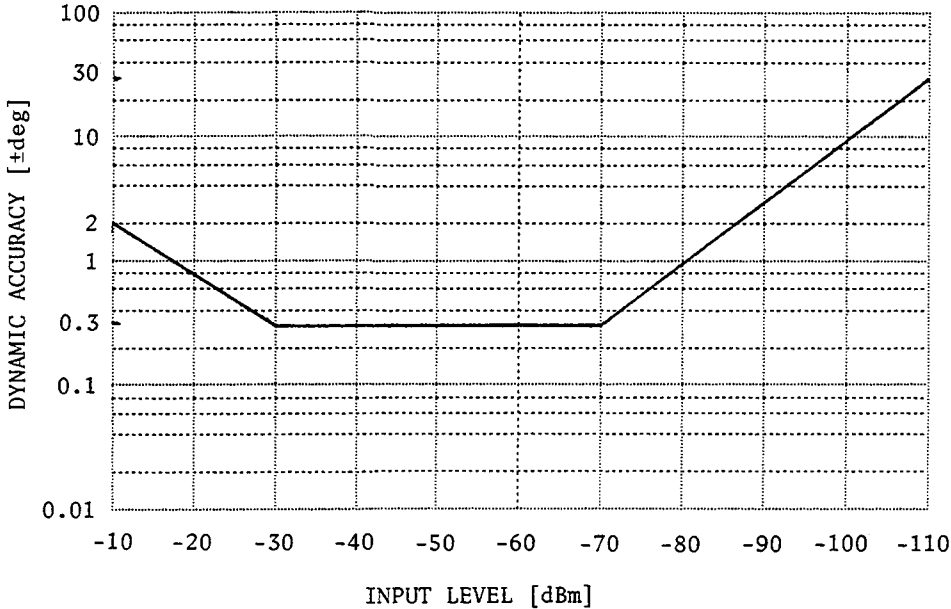

Where: IF range: Normal mode
Attenuators: 0 dB
Reference Input Level: -30 dBm
Resolution Band Width: 10 Hz

- Frequency Response: (Deviation from linear phase. The frequency response error can be reduced by the Normalize.)

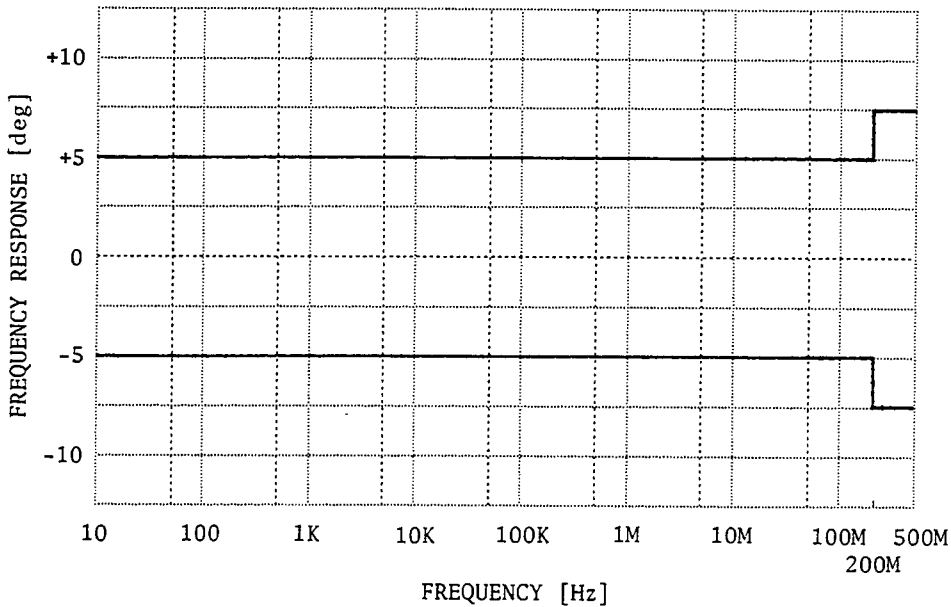

Where, the Input Attenuators for two inputs must be the same value, respectively.

Table 7-1. Specifications (6 of 15)

Group Delay:	
• Range:	100 fsec to 500 sec
• Resolution:	$(2.78 \times 10^{-5}) / (\text{Aperture Frequency by Hz}) \text{ sec}$
• Aperture Frequency:	0.5% to 100% of SPAN at 401 point sweep
• Accuracy (at $23 \pm 5^{\circ}\text{C}$):	$\frac{\text{Dynamic Phase Accuracy (deg)}}{360 \text{ (deg)} \times \text{Aperture Frequency (Hz)}} \text{ (sec)}$
Calibration:	
• NORMALIZE:	Compensates for the frequency response error at the transmission or reflection measurement.
• 1 Port Partial Calibration:	Compensates for the frequency response error and the directivity error.
• 1 Port Full Calibration:	Compensates for the frequency response error, the directivity error, and the source match error.
• Port Extension:	Compensates for phase shift existing in the extension from the calibration plane. A new reference plane can be defined from -999.99 to +999.99 cm with 0.01 cm resolution.

Table 7-1. Specifications (7 of 15)

SPECTRUM MEASUREMENT

Frequency:

- Measurement Range: 10 Hz to 500 MHz
- Accuracy (CENTER, SPAN, START, STOP):
 - ±20 ppm (23 ±5 °C)
 - ±1 ppm (23 ±5 °C, Option 001)
- Resolution:
 - Resolution Bandwidth(3 dB): 3 Hz to 300 kHz, 1, 3, 10 steps
 - Selectivity (60 dB/3 dB):
 - <4.5 at RBW ≤ 30 Hz
 - <9 at 100 Hz ≤ RBW ≤ 10 kHz
 - <8.5 at RBW ≥ 30 kHz
- Band Width Accuracy: ±10%
- Standard Frequency Stability:
 - ±5 × 10⁻⁶/day (23 ±5 °C, Typical)
 - ±1 × 10⁻⁸/day (23 ±5 °C, with Option 001)
- Noise Sideband:
 - <-100 dBc/Hz at 20 kHz offset, SPAN≤2.4MHz
 - <-100 dBc/Hz at 1 kHz offset, SPAN≤2.4 MHz
 - <-90 dBc/Hz at 100 Hz offset, SPAN≤2.4 MHz
- SSB Noise (Typical):

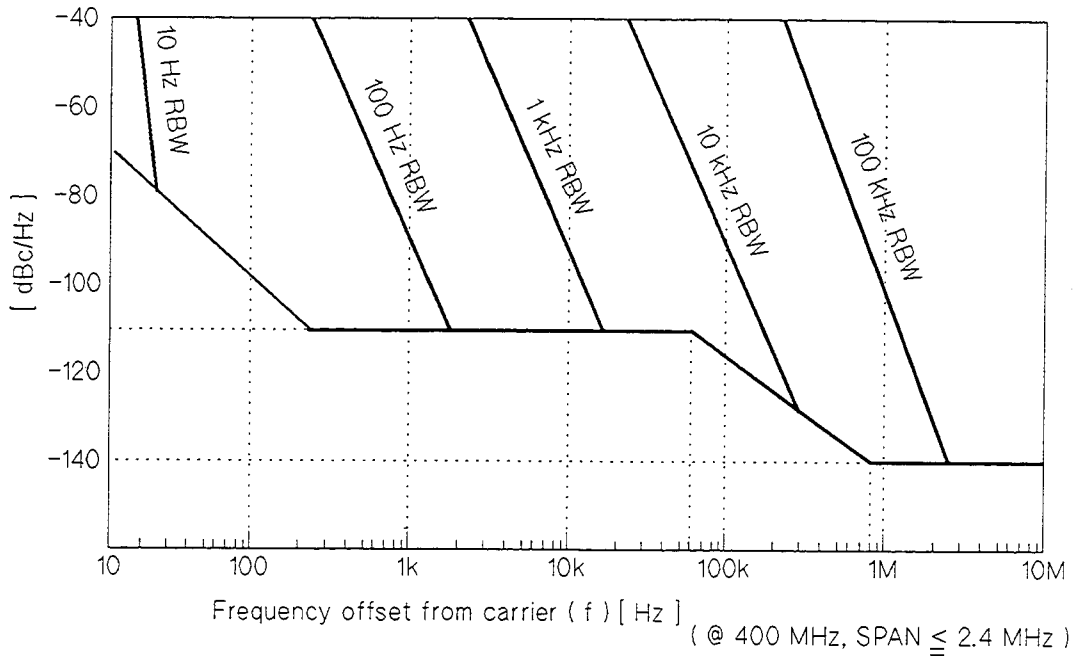

Table 7-1. Specifications (8 of 15)

Input Characteristics:

- Inputs: 4 Inputs (R1, T1, R2, T2)
- Impedance: Nominal 50Ω
Return Loss ≥15 dB
- Attenuator: 0 to 50 dB, 10 dB step (for all Inputs)
- IF Range: Normal mode, Low Distortion mode, or High Sensitivity mode is selectable.
- Input Range: Input Range is changed by the Input Attenuator, and IF Range, as follows. The value of Input Range is displayed on the System Message Line.

Attenuator	IF Range		
	Normal	Low Distortion	High Sensitivity
0 dB	-20 dBm	-30 dBm	-40 dBm
10 dB	-10 dBm	-20 dBm	-30 dBm
20 dB	0 dBm	-10 dBm	-20 dBm
30 dB	10 dBm	0 dBm	-10 dBm
40 dB	20 dBm	10 dBm	0 dBm
50 dB	20 dBm	20 dBm	10 dBm

- Maximum Input Level: +20 dBm
- Damage Level: +30 dBm or ±7 VDC (Typical)

Table 7-1. Specifications (9 of 15)

Amplitude:

- Measurement Range: -135 dBm to +20 dBm
- Unit: dBm, dB μ V, Vrms, dBm/Hz, and μ Vrms/ \sqrt Hz
- Accuracy: ± 1.0 dB at 50 MHz, 23 ± 5 °C (at the upper limit level of Input Range)
- Linearity (at 23 ± 5 °C):

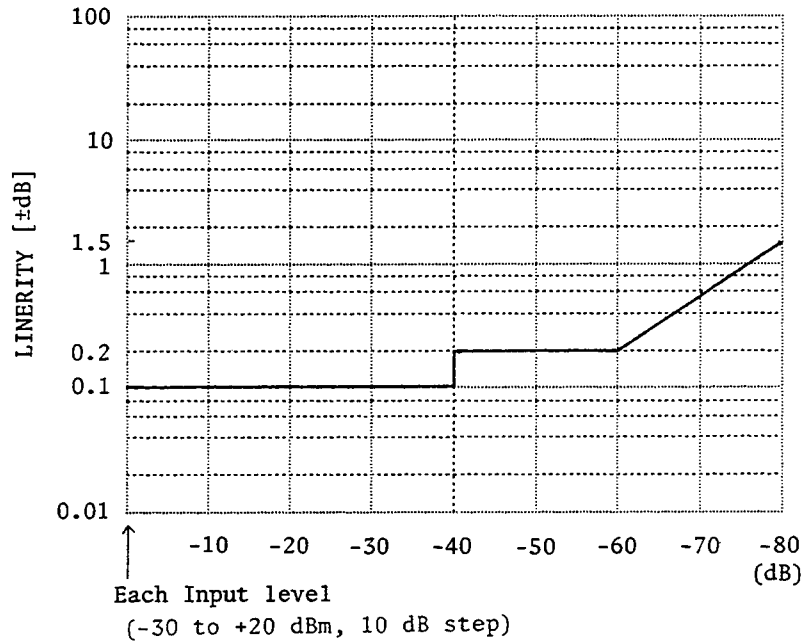

Where: IF Range: Low Distortion mode
Resolution Band Width: 10 Hz

- Frequency Response: ± 1.5 dB when Attenuator= 10 dB

Table 7-1. Specifications (10 of 15)

Dynamic Range: (at 23 ±5 °C)

- Spurious Response: ≤-70 dBc
(at the frequency offset from carrier ≥100 kHz when SPAN > 2.4 MHz)
- 2nd Harmonics Distortion: ≤-70 dBc referenced to the sinusoidal signals (≥2 MHz) which is equal to every Input Ranges

(IF Range: Low Distortion mode)
- 3rd Order Intermodulation Distortion: ≤-80 dBc referenced to two sinusoidal signals (≥2 MHz; 500 kHz separation) which are lower 6dB than every Input Ranges
(IF Range: Low Distortion mode)
- Residual Response: -110 dBm at ≥100 kHz, Attenuator= 0 dB
(IF Range: High Sensitivity mode)
- Averaging Noise Level (Typical):

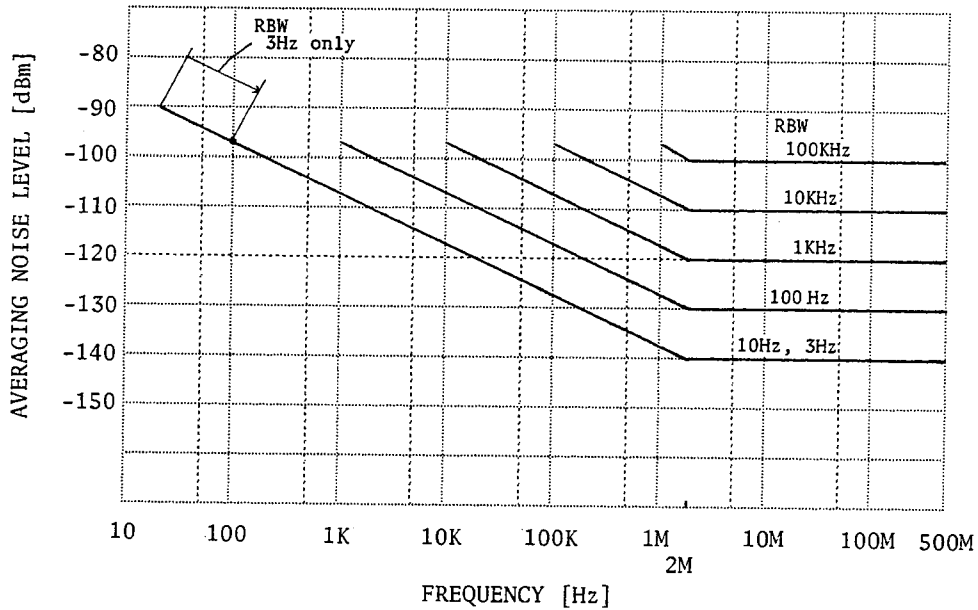

Where: IF Range: High Sensitivity mode
Attenuator: 0 dB

Table 7-1. Specifications (11 of 15)

• Dynamic Range Chart:

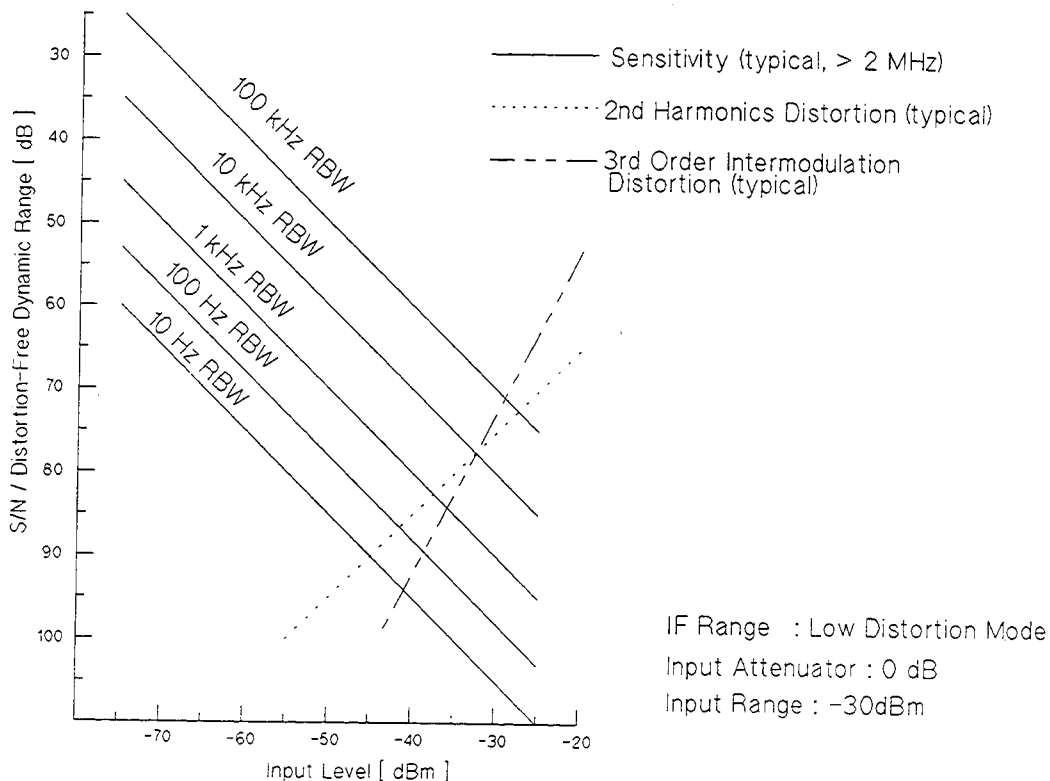

Sweep:

- Sweep Type: Liner, Log, CW, Programmed Points, and Partial
- Sweep Mode: Continuous, Single, and Manual
- Trigger Mode: Internal, External, and Manual
- Sweep Time: (where Display points : 401 points)

Span	RBW	Measurement Time/point
500 MHz	300 kHz	approximately 3.5 sec
100 MHz	300 kHz	approximately 750 msec
50 MHz	300 kHz	approximately 350 msec
1 MHz	3 kHz	approximately 1 sec
100 kHz	300 Hz	approximately 11 sec

Table 7-1. Specifications (12 of 15)

IMPEDANCE MEASUREMENT

The following specifications are applied only when the 4195A is used with the HP 41951A Impedance Test Kit.

Measurement Parameter:	$ Z $, $ Y $, θ , R, X, G, B, L, C, D, Q (=1/D)
Frequency Range:	100 kHz to 500 MHz
Test Signal Level:	-62 dBm to +3 dBm at 50Ω load
DC Bias Level:	±40 V (Max. 20 mA)
Measurement Range:	30 mΩ to 30 kΩ (Typical, after a 1 Port Calibration)
Measurement Basic Accuracy:	(Typical, at 23 ±5 °C, after a 1 Port Calibration)

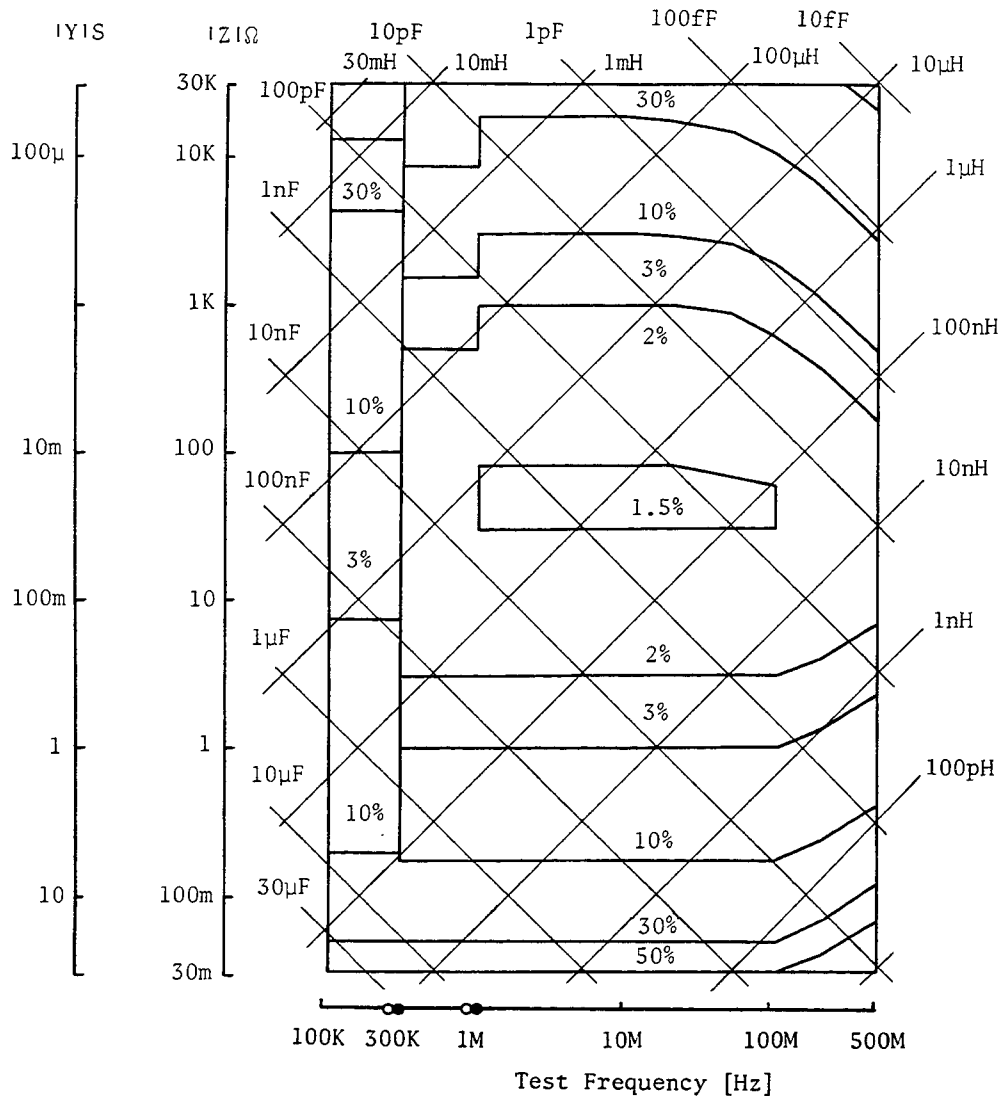

Table 7-1. Specifications (13 of 15)

Error Correction Capability:	<ul style="list-style-type: none">• 1 Port Full Calibration• Open/Short Offset Compensation• Port Extension
Equivalent Circuit Analysis Capability:	
<ul style="list-style-type: none">• Approximation:	Approximate equivalent circuit constants using impedance measurement data.
<ul style="list-style-type: none">• Simulation:	Simulate the frequency characteristics of impedance by specifying the equivalent circuit constants.

Table 7-1. Specifications (14 of 15)

--- AVAILABLE FUNCTIONS ---	
DISPLAY AND ANALYSIS:	
Display:	7.5 inch color CRT
Display Format:	Rectangular (X-A&B, A-B), Smith chart, Polar chart, and Table
Trace:	Maximum 4 traces
Scale Type:	Liner, Log
Auto Scaling Function:	Optimize scaling of the displayed data
Phase Display Extend Function:	Displays continuously the phase over ± 180 deg.
Video Filter:	Average the measurement data of four measurements.
Comment Entry:	Display up to a 26 character comment on the CRT.
Marker:	NEXT PEAK, Marker Target, Delta Marker, NOISE Marker, MKR \rightarrow MAX(MIN, REF, CENTER, START, STOP)
Math Operator/Math Function:	+, -, *, /, SQR, EXP, LOG, LN, SIN, COS, TAN, ATAN, ABS, DIF, MAX(,), MIN(,), COMPLEX< , > and etc.
USER FUNCTION:	
User Math Function:	Change the format of the measured data, using the math operators/math functions at the real time.
User Defined Function:	Define the control of measurement and analysis to a softkey.
User Program:	Control the 4195A's operation using the internal program language. The program can be entered using the front panel keys or down loaded from a host computer using HP-IB.

Table 7-1. Specifications (15 of 15)

HARD COPY:

Copy to HP plotters or printers set to the LISTEN ONLY mode without an external computer.

- DUMP Graphics mode:** Copy the CRT display on a graphics printer.
- Color DUMP Graphics mode:** Copy the CRT display on a color graphics printer (fixed color).
- PLOT mode:** Copy the CRT display on a plotter for a color hardcopy.
- PRINT mode:** Output measurement data in tabular form on a printer.

STORAGE

Save/get the measurement condition, measured data, User Program (ASP), programmed points table to the 3.5 inch flexible disc by the internal disc drive.

- Capacity:** 630 k byte, Double Sided
- Format:** LIF

REMOTE PROGRAMMING

Based on IEEE STD 488-1978, IEEE STD 728-1982.

- Interface Function:** SH1, AH1, T5, TE0, L4, LE0, SR1, RL1, PP0, DC1, DT1, C0, E1
- Data Output Format:** ASCII, Binary IEEE 32 or 64 bit
- Data Transfer Rate (Typical):** Using the **ENTER** command with an HP 9000 series 310 computer, 401 point data.

Data Format	Transfer Rate
ASCII	Approximately 700 msec
Binary 32-bit	Approximately 40 msec
Binary 64-bit	Approximately 90 msec

Table 7-2. Options

Option Number	Description
001	High Stability Frequency Reference Test Frequency Accuracy: ± 1 ppm (23 $\pm 5^{\circ}\text{C}$) Stability: $\pm 1 \times 10^{-8}$ /day (23 $\pm 5^{\circ}\text{C}$)
907 * ¹	Front Handle Kit
908 * ¹	Rack Flange Kit
909 * ¹	Rack & Handle Kit
910	Extra Operation Manual (English)
91P	Extra Operation Manual (Japanese)

*¹: Installation procedures for these options are detailed in paragraph 7-6.

Table 7-3. Furnished Accessories

Description	Qty.	HP Part Number or Model Number
Disc Kit 3.5inch Disc (2ea.) Disc Case (1ea.)	1 ea.	04195-61001
Cable Assy (Power)	1 ea.	04194-61603
Cable Assy (Control)	1 ea.	04194-61602
BNC-BNC Cable	3 ea.	8120-1838
BNC-BNC Cable (Option 001 only)	1 ea.	04194-61601
Rear Panel Lock Foot Kit Full Modules	1 ea.	5061-9699
Power Cable	1 ea.	8120-1378
Maintenance Manual	1 ea.	04195-90100
User's Guide	1 ea.	5950-2942

Table 7-4. Available Accessories (1 of 7)

Model	Description
<p data-bbox="423 352 553 384">11850C/D</p> 	<p data-bbox="751 352 1084 384">Three-Way Power Splitters</p> <p data-bbox="751 415 1409 478">The 11850C/D are used with the 4195A for the transmission measurement from 10 Hz to 500 MHz.</p> <p data-bbox="751 510 1065 541">Insertion Loss (Nominal):</p> <p data-bbox="816 541 1203 573">11850C: 9.5 dB + 1 dB/GHz</p> <p data-bbox="816 573 1040 604">11850D: 7.8 dB</p> <p data-bbox="751 604 1300 636">Equivalent Source Match: 30 dB at 1.3 GHz</p> <p data-bbox="751 636 1219 667">Input Port Match: 20 dB at ≤ 1.3 GHz</p> <p data-bbox="751 667 1214 699">Maximum Operating Level: +20 dBm</p> <p data-bbox="751 699 946 730">RF Connectors:</p> <p data-bbox="816 730 1154 762">RF Input: 50Ω type N(f)</p> <p data-bbox="816 762 1268 793">Test Port: 11850C: 50Ω type N(f)</p> <p data-bbox="987 793 1268 825">11850D: 75Ω type N(f)</p>
<p data-bbox="440 894 537 926">11667A</p> 	<p data-bbox="751 894 1057 926">Power Splitter (Type N)</p> <p data-bbox="751 957 1409 1020">The 11667A is used to measure the transmission characteristics at 10 Hz to 500 MHz.</p> <p data-bbox="751 1052 1149 1083">Insertion Loss (Nominal): 6 dB</p> <p data-bbox="751 1083 1154 1115">Equivalent Source Match: 26 dB</p> <p data-bbox="751 1115 1052 1146">Input Port Match: 23 dB</p> <p data-bbox="751 1146 1214 1178">Maximum Operating Level: +27 dBm</p> <p data-bbox="751 1178 1073 1209">Connectors: 50Ω type N(f)</p>
<p data-bbox="440 1276 537 1308">11852B</p> 	<p data-bbox="751 1276 1089 1308">50-75Ω Minimum Loss Pad</p> <p data-bbox="751 1339 1170 1371">Insertion Loss (Nominal): 5.7 dB</p> <p data-bbox="751 1371 1268 1402">Return Loss: 26 dB (50Ω), 30 dB (75Ω)</p> <p data-bbox="751 1402 1154 1434">Maximum Input Level: +24 dBm</p> <p data-bbox="751 1434 1284 1465">Connectors: 50Ω type N(f) - 75Ω type N(m)</p>

Table 7-4. Available Accessories (2 of 7)

Model	Description
<p data-bbox="418 359 516 386">41800A</p> 	<p data-bbox="727 359 889 386">Active Probe</p> <p data-bbox="727 422 1393 516">The 41800A is high impedance probe used to perform probing measurements when using the 4195A from 5 Hz to 500 MHz.</p> <p data-bbox="727 552 1208 579">Probe Gain: 0 dB \pm0.5 dB, at 50 MHz</p> <p data-bbox="727 583 1224 642">Input Resistance/Capacitance (Typical): 100 kΩ, 3 pF</p> <p data-bbox="727 646 1122 705">Frequency Response: \pm1 dB, at 50 Hz to 200 MHz</p> <p data-bbox="727 709 1105 768">Average Noise Level (Typical): 10 nV/\sqrtHz, at \geq300 kHz</p> <p data-bbox="727 772 883 800">Accessories:</p> <ul style="list-style-type: none"> <li data-bbox="760 804 1198 831">HP 10218A Probe-BNC(m) Adapter <li data-bbox="760 835 1003 863">10:1 / 100:1 Divider <li data-bbox="760 867 1110 894">Slip-on Spanner Ground Tip <li data-bbox="760 898 1024 926">Ground Clip (flexible) <li data-bbox="760 930 1016 957">Probe Tip Nut Driver <li data-bbox="760 961 1130 989">HP 10229A Hook Tip Adapter <li data-bbox="760 993 1016 1020">Spare Probe Pin Set <li data-bbox="760 1024 1146 1052">Operation Note, Carrying Case
<p data-bbox="402 1121 526 1148">41952A/B</p> 	<p data-bbox="727 1121 1143 1148">Transmission/Reflection Test Set</p> <p data-bbox="727 1184 1386 1278">The 41952A/B are used with the 4195A to measure the transmission/reflection characteristics from 100 kHz to 500 MHz.</p> <p data-bbox="727 1314 1105 1373">Impedance: 41952A: 50 Ω 41952B: 75 Ω</p> <p data-bbox="727 1377 1273 1472">Directivity: 41952A: 40 dB, at 300 kHz to 200 MHz 41952B: 35 dB, at 300 kHz to 200 MHz</p> <p data-bbox="727 1476 1273 1570">Insertion Loss (Nominal, Input to Test Port): 41952A: 13 dB 41952B: 19 dB</p> <p data-bbox="727 1575 1159 1633">Effective Source Match (Test Port): \geq20 dB, at \geq300 kHz</p> <p data-bbox="727 1638 1049 1732">Connector (Test Port): 41952A: 50 Ω, type N(f) 41952B: 75 Ω, type N(f)</p> <p data-bbox="727 1736 1305 1856">Accessories: 50 Ω N(m)-N(m) Cable 11852B Minimum Loss Pad (41952B only) Operation Note, Carrying Case</p> <p data-bbox="727 1860 1338 1955">Option: Option 009 (41952B only): Delete N(m)-N(m) cable and 11852B</p>

Table 7-4. Available Accessories (3 of 7)

Model	Description
<p data-bbox="430 359 555 386">85044A/B</p> 	<p data-bbox="756 359 1170 386">Transmission/Reflection Test Set</p> <p data-bbox="756 426 1419 516">The 85044A/B are used with the 4195A to measure the transmission/reflection characteristics from 300 kHz to 500 MHz.</p> <p data-bbox="756 554 1133 581">Directivity: 35 dB at ≤ 1.3 GHz</p> <p data-bbox="756 585 938 613">Insertion Loss:</p> <p data-bbox="756 617 1110 644">(Nominal, Input to Test Port)</p> <p data-bbox="786 648 1179 676">85044A: 12.5 dB + 0.5 dB/GHz</p> <p data-bbox="786 680 1133 707">85044B: 22 dB + 1 dB/GHz</p> <p data-bbox="756 711 1230 739">Equivalent Source Match (Test Port):</p> <p data-bbox="786 743 1373 770">85044A: 15 dB at ≤ 2 MHz, 20 dB at ≤ 1.3 GHz</p> <p data-bbox="786 774 1373 802">85044B: 15 dB at ≤ 2 MHz, 17 dB at ≤ 1.3 GHz</p> <p data-bbox="756 806 1218 833">Maximum Operating Level: +20 dBm</p> <p data-bbox="756 837 1414 898">DC Bias Range: ± 30 VDC, ± 200 mA, Max. ± 500 mA</p> <p data-bbox="756 903 1045 930">Connector (Test Port):</p> <p data-bbox="786 934 967 961">85044A: 7 mm</p> <p data-bbox="786 966 1068 993">85044B: 75 Ω type N(f)</p> <p data-bbox="756 997 906 1024">Accessories:</p> <p data-bbox="786 1029 1382 1056">85044A: 7 mm-50 Ω type N(f) Adapter (1 ea.)</p> <p data-bbox="786 1060 1365 1087">85044B: 11852B Minimum Loss Pad (1 ea.)</p>
<p data-bbox="430 1157 555 1184">35676A/B</p> 	<p data-bbox="756 1157 1260 1184">50/75 Ω Reflection/transmission Test Kit</p> <p data-bbox="756 1224 1419 1314">The 35676A/B are used with the 4195A for the transmission/reflection measurement from 10 Hz to 200 MHz.</p> <p data-bbox="756 1352 1019 1379">Test Port Impedance:</p> <p data-bbox="786 1383 1019 1411">35676A: 50 Ω $\pm 2\%$</p> <p data-bbox="786 1415 1019 1442">35676B: 75 Ω $\pm 2\%$</p> <p data-bbox="756 1446 1195 1474">Insertion Loss (Input to Test port):</p> <p data-bbox="954 1478 1122 1505">10 dB ± 1 dB</p> <p data-bbox="756 1509 1122 1537">Equivalent Directivity: > 40 dB</p> <p data-bbox="756 1541 1068 1568">Equivalent Source Match:</p> <p data-bbox="786 1572 992 1600">35676A: > 30 dB</p> <p data-bbox="786 1604 992 1631">35676B: > 25 dB</p>

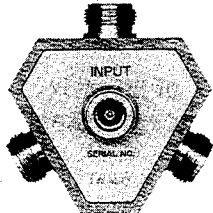
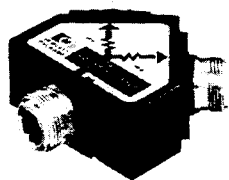
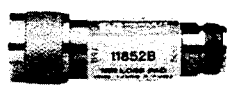
Table 7-4. Available Accessories (4 of 7)

Model	Description
11851B	RF Cable Kit 610 mm 50 Ω cable (3 ea.), 810 mm cable (1 ea.)
11857B	75 Ω Type N Test Port Extension Cables 610 mm cable (2 ea.)
11853A	50 Ω Type N Accessory Kit
11854A	50 Ω BNC Accessory Kit
11855A	75 Ω Type N Accessory Kit
11856A	75 Ω BNC Accessory Kit
85031B	7 mm Calibration Kit
85032B	50 Ω Type N Calibration Kit
85033C	3.5 mm Calibration Kit
85036B	75 Ω Type N Calibration Kit
85033A	SMA Calibration Kit

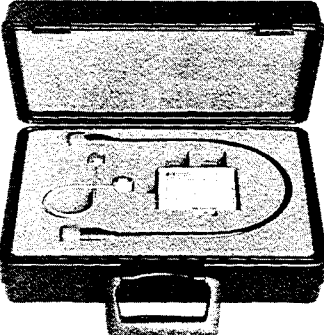
Table 7-4. Available Accessories (5 of 7)

Model	Description																		
<p data-bbox="435 363 529 390">41951A</p> 	<p data-bbox="743 363 992 390">Impedance Test Kit</p> <p data-bbox="743 426 1406 489">The 41951A is used with the 4195A for the impedance measurement from 100 kHz to 500 MHz.</p> <p data-bbox="743 522 1406 585">Contains the following accessories in a carrying case.</p> <table data-bbox="756 619 1273 905"> <tr> <td>Impedance Test Adapter</td> <td>1</td> </tr> <tr> <td>50 Ω Termination</td> <td>1</td> </tr> <tr> <td>Open Termination</td> <td>1</td> </tr> <tr> <td>Short Termination</td> <td>1</td> </tr> <tr> <td>N(m)-N(m) Adapter</td> <td>2</td> </tr> <tr> <td>N-type Cable</td> <td>1</td> </tr> <tr> <td>BNC Cable</td> <td>1</td> </tr> <tr> <td>Operation Note</td> <td>1</td> </tr> <tr> <td>Carrying Case</td> <td>1</td> </tr> </table>	Impedance Test Adapter	1	50 Ω Termination	1	Open Termination	1	Short Termination	1	N(m)-N(m) Adapter	2	N-type Cable	1	BNC Cable	1	Operation Note	1	Carrying Case	1
Impedance Test Adapter	1																		
50 Ω Termination	1																		
Open Termination	1																		
Short Termination	1																		
N(m)-N(m) Adapter	2																		
N-type Cable	1																		
BNC Cable	1																		
Operation Note	1																		
Carrying Case	1																		
<p data-bbox="431 968 526 995">16091A</p> 	<p data-bbox="740 968 943 995">Coaxial Fixtures</p> <p data-bbox="740 1031 1403 1188">Test Fixtures (coaxial termination type) for holding a piece of sample holders accommodate a cylindrical sample in their respective inner chambers. Two kinds of fixtures fit samples dimensions given below:</p> <table data-bbox="776 1241 1300 1472"> <thead> <tr> <th>Sample</th> <th>Fixture</th> <th colspan="2">Max. dimensions</th> </tr> </thead> <tbody> <tr> <td rowspan="2">  </td> <td rowspan="2">04191-85302</td> <td>d</td> <td>7 mm</td> </tr> <tr> <td>ℓ</td> <td>20 mm</td> </tr> <tr> <td rowspan="2"></td> <td rowspan="2">16091-60012</td> <td>d</td> <td>10 mm</td> </tr> <tr> <td>ℓ</td> <td>20 mm</td> </tr> </tbody> </table> <p data-bbox="740 1545 1273 1640">Usable frequency range: DC to 1000 MHz. Electrical length: 1.87 cm (typical). Maximum applied dc bias voltage: \pm 40 V.</p> <p data-bbox="740 1671 1403 1860">NOTE: The 16091A fixture of 7 mm inner diameter (P/N 04191-85302) is the OS standard termination furnished with the HP 41951A. Thus, this fixture is not supplied with the 16091A fixture set since the OS termination can be used.</p>	Sample	Fixture	Max. dimensions			04191-85302	d	7 mm	ℓ	20 mm		16091-60012	d	10 mm	ℓ	20 mm		
Sample	Fixture	Max. dimensions																	
	04191-85302	d	7 mm																
		ℓ	20 mm																
	16091-60012	d	10 mm																
		ℓ	20 mm																

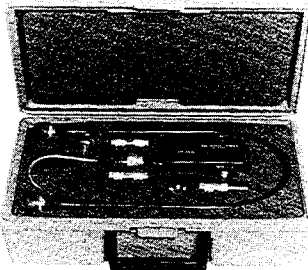
Table 7-4. Available Accessories (6 of 7)

Model	Description
<p data-bbox="418 352 516 382">16092A</p> 	<p data-bbox="727 352 966 382">Spring Clip Fixture</p> <p data-bbox="727 420 1388 577">Test Fixture (direct attachment type) for measurement of both axial and radial lead components and leadless chip elements. Spring clip contacts are capable of holding samples of dimensions given below:</p>  <p data-bbox="727 934 1388 1081">A combined slide gauge provides direct read-out of the physical length of the test sample. Usable frequency range: dc to 500 MHz Electrical length: 0.34 cm typical Maximum applied dc bias voltage: ±40 V.</p>
<p data-bbox="410 1119 508 1148">16093A</p> 	<p data-bbox="719 1119 868 1148">Test Fixture</p> <p data-bbox="719 1186 1388 1344">Test Fixture (direct attachment type) for measurement of both axial and radial lead miniature components. Two binding post terminals at an interval of 7 mm on the terminal deck ensure optimum contact of terminals and sample leads.</p>  <p data-bbox="719 1690 1242 1795">Usable frequency range: dc to 250 MHz Electrical length: 0.34 cm typical Maximum applied dc bias voltage: ± 40V.</p>

Table 7-4. Available Accessories (7 of 7)

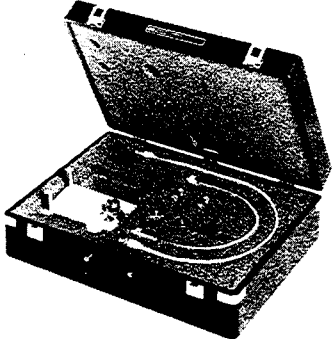
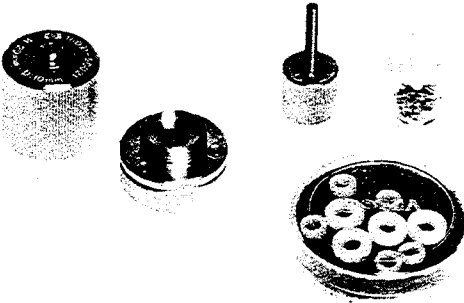
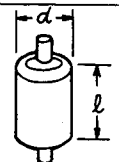
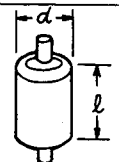
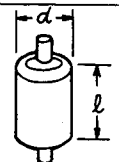

Model	Description
<p data-bbox="446 359 544 386">16093B</p> 	<p data-bbox="755 359 1015 386">Binding Post Fixture</p> <p data-bbox="755 426 1421 548">Test Fixture (direct attachment type) for general measurement of both axial and radial lead components. Three binding post terminals are located on the terminal deck as shown below:</p>  <p data-bbox="755 905 1274 999">Usable frequency range: dc to 125 MHz Electrical length: 0.34 cm typical Maximum applied dc bias voltage: ± 40 V.</p>
<p data-bbox="438 1060 535 1087">16094A</p> 	<p data-bbox="755 1060 917 1087">Probe Fixture</p> <p data-bbox="747 1127 1421 1413">Test Fixture for measurement of circuit impedances and components mounted on circuit assemblies. The probe adapter unit can be attached at the tip of an extension line connected to the test port. The probe connector fits APC-7 connector of a coaxial test cable or a flexible air line. Probe needle interval is variable from 1 mm to 15 mm. Electrical length compensation in the instrument must be adjusted for probe cable length.</p> <p data-bbox="747 1451 1274 1545">Usable frequency range: DC to 125 MHz. Electrical length: 2.32 cm (typical). Maximum applied dc bias voltage: ± 40 V.</p>

Table 7-5. Accessories Selection Guide for Network Measurement

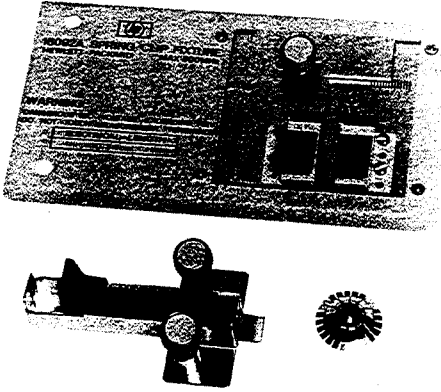
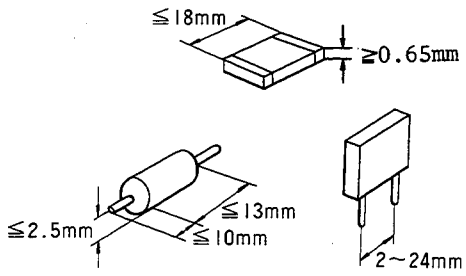
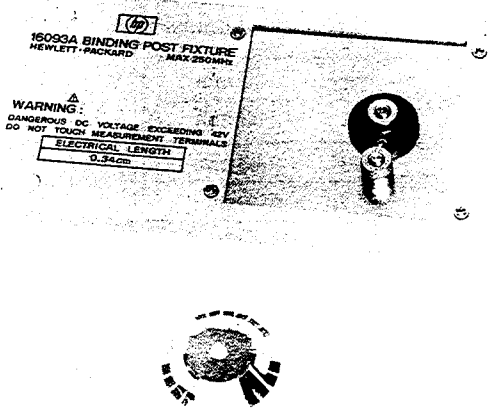
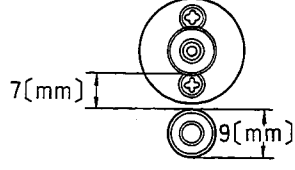
	50Ω			75Ω		
	T	T/R	S	T	T/R	S
Power Splitter	11850C 11667A			11850D		
Test Set		41952A 35676A	41952A* ¹ 35676A* ¹		41952B 35676B	41952B* ¹ 35676B* ¹
Cable	11851B	11851B		11851B 11857B	11857B	11857B
Accessory Kit N-type BNC-type	11853A 11854A	11853A 11854A	11853A 11854A	11855A 11856A	11855A 11856A	11855A 11856A
Calibration Kit 7 mm N-type 3.5 mm		85031B 85032B 85033C	85031B 85032B 85033C		85036B	85036B

T: Transmission measurement
T/R: Transmission/Reflection measurement
S: S-Parameter measurement

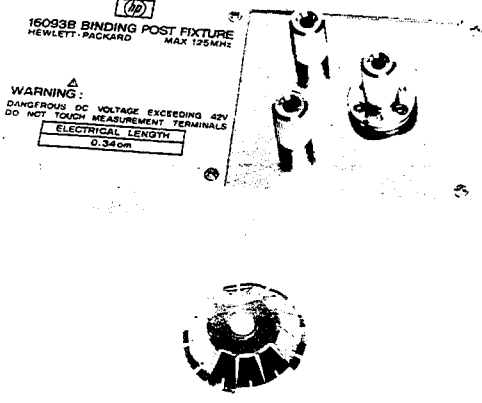
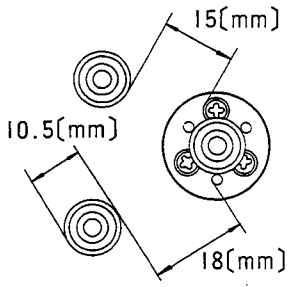
*¹: For S-Parameter measurement, two sets of the same model (Option 009 for 41952B) are required.

APPENDIX A

MANUAL BACKDATING

This appendix contains the information required to adapt this manual to earlier versions or configurations of the HP 4195A than the current printing date of this manual. The information in this manual applies directly to HP 4195A Network/Spectrum Analyzers whose serial number prefix is listed on the title page of this manual.

To adapt this manual to your HP 4195A, refer to Table A and B, and make all of the manual changes listed opposite your instrument's serial number and ROM-based firmware's version.

Instruments manufactured after the printing of this manual may be different than those documented in this manual. Later instrument versions will be documented in a manual changes supplement that will accompany the manual shipped with that instrument. If your instrument serial number is not listed on the title page of this manual or in Table A, it may be documented in the **yellow MANUAL CHANGES** supplement. Refer to the description of the **REV?** command in paragraph 6-5-3 for confirmation of the ROM-based firmware's version. For additional information on serial number coverage, refer to **SERIAL NUMBER** in **SECTION 7** of this **Operation Manual**.

Table A. Manual Changes by Serial Number

Serial Prefix or Number	Make Manual Changes
2738J and below	2

Table B. Manual Changes by Firmware's Version

Version	Make Manual Changes
Rev 1.00	1,3
Rev 1.01	3

CHANGE 1

- 1) Add the following **NOTE** to procedure 5 of paragraph 3-4, IMPEDANCE MEASUREMENT EXAMPLE.

NOTE

If the OS/O Ω offset compensation is used to compensate for residual impedance and stray admittance of the test fixture, press the **'return'** softkey, the **'COMPEN menu'** softkey, the appropriate compensation type softkey, and **'return'** softkey. Refer to paragraph 4-8, for details.

- 2) When the calibration/compensation are used ('CORRECTN on off' softkey is set to on), **Cor** will be displayed in the function area of the screen. When the stimulus setting is changed from the setting used for calibration/compensation, **Cor?** will be displayed instead of **Cor**.
- 3) When the **TRACE VIEW** key is pressed, the '**STORE A,B→C,D**' softkey label will be displayed on the sixth line from the top of the softkey area.

CHANGE 2

Change the following items.

Page 4-58, 4-16-1. EXTERNAL REFERENCE SIGNAL INPUT

Frequency: 10/N MHz, ± 10 ppm ...
 --> 10/N MHz, ± 30 ppm ...

Page 7-7, Table 7-1 (1 of 15), EXTERNAL STANDARD FREQUENCY INPUT

Frequency: 10/N MHz, ≤ 10 ppm ...
 --> 10/N MHz, ≤ 30 ppm ...

Page 7-8, Table 7-1 (2 of 15), Output: Spectrual Purity:

Phase Noise: < -100 dBc/Hz at 20 kHz offset, SPAN ≤ 2.4 MHz
 --> < -90 dBc/Hz at 20 kHz offset

Sweep:

Power Sweep Linearity: "at -50 dBm to +10 dBm" --> *DELETE*

Page 7-11, Table 7-1 (5 of 15), Phase:

Frequency Response: "Deviation from linear phase." --> *DELETE*

Page 7-13, Table 7-1 (7 of 15), Frequency:

Resolution: Selectivity (60 dB/3 dB): < 9 at 100 Hz ≤ RBW ≤ 10 kHz
 --> < 12

Noise Sideband: <-100 dBc/Hz at 20 kHz offset, SPAN≤2.4MHz
 <-100 dBc/Hz at 1 kHz offset, SPAN≤2.4 MHz
 <-90 dBc/Hzat 100 Hz offset, SPAN≤2.4 MHz
 --> <-90 dBc/Hz at 20 kHz offset

SSB Noise (Typical) --> *DELETE*

Page 7-16, Table 7-1 (10 of 15), Dynamic Range:

Spurious Response: ≤-70 dBc (at the frequency offset from carrier ≥100 kHz when SPAN > 2.4 MHz)
 --> ≤-70 dBc at |Δf| > 100 kHz offset
 ≤-60 dBc at 10 kHz < |Δf| ≤ 100 kHz
 ≤-50 dBc at |Δf| ≤ 10 kHz
 |Δf| is frequency deviation of carrier

Page 7-17, Table 7-1 (11 of 15)

Dynamic Range Chart --> *DELETE*

CHANGE 3

Change the following items.

Page 3-5, 3-3. SPECTRUM MEASUREMENT EXAMPLE

Procedure 5. **ATR1= 10 DB --> ATR1= 20 DB**

Procedure 6. Press the **arrow up** key three times.
--> Press the **arrow up** key two times.

Page 3-8, 3-4. IMPEDANCE MEASUREMENT EXAMPLE

Procedure 6. **ATR1= 10 DB --> ATR1= 20 DB**

Procedure 8. **ATT1= 10 DB --> ATT1= 20 DB**

Procedure 7., 9. *DELETE*

Procedure 19. **Calculating CAL coefficient**
--> **LOAD calibration completed**

Procedure 21. Press the '**COMPEN menu**' softkey ...
--> Press the '**return**' softkey, then press the '**COMPEN menu**' softkey ..

Procedure 25. **Compen completed (TURN ON "CORR" KEY)**
--> **0 Ω Compensation completed**

Procedure 26. Press the '**CORRECTN on off**' softkey.
--> Press the '**return**' softkey, then press the '**CORRECTN on off**' softkey.

Page 4-8, 1. Transmission Calibration Procedure

Procedure 9. **CAL completed (TURN ON "CORR" KEY)**
--> **Thru Calibration complete**

Procedure 11. Press the '**CORRECTN on off**' softkey.
--> Press the '**return**' softkey, then press the '**CORRECTN on off**' softkey.

Page 4-10, 2. Reflection Calibration Procedure

Procedure 20. **CAL completed (TURN ON "CORR" KEY)**
--> **Open Calibration complete**

Procedure 22. Press the '**CORRECTN on off**' softkey.
--> Press the '**return**' softkey, then press the '**CORRECTN on off**' softkey.

Page 4-52, Table 4-16

	<u>Parameter</u>	<u>Initial Setting</u>
<i>ADD</i>	AUTO (Coupled to Span) on/off	on

Page 4-53, NETWORK measurement

	<u>Parameter</u>	<u>Initial Setting</u>
<i>DELETE</i>	AUTO (Coupled to Span) on/off	off
<i>DELETE</i>	Resolution Bandwidth (RBW)	10 kHz

SPECTRUM measurement

	<u>Parameter</u>	<u>Initial Setting</u>
<i>DELETE</i>	AUTO (Coupled to Span) on/off	on
<i>DELETE</i>	Resolution Bandwidth (RBW)	300 kHz
<i>CHANGE</i>	Reference Value for data A	-10 dBm --> 0 dBm
<i>CHANGE</i>	Bottom Value for data A	-110 dBm --> -100 dBm
<i>CHANGE</i>	Reference Value for data B	-10 dBm --> 0 dBm
<i>CHANGE</i>	Bottom Value for data B	-110 dBm --> -100 dBm

Page 4-54, (3) IMPEDANCE measurement

	<u>Parameter</u>	<u>Initial Setting</u>
<i>DELETE</i>	AUTO (Coupled to Span) on/off	off
<i>DELETE</i>	Resolution Bandwidth (RBW)	3 kHz
<i>CHANGE</i>	IF Range	High Sensitivity --> Normal

(4) S-Parameter measurement (S11, S12, S21, and S22)

	<u>Parameter</u>	<u>Initial Setting</u>
<i>DELETE</i>	AUTO (Coupled to Span) on/off	off
<i>DELETE</i>	Resolution Bandwidth (RBW)	10 kHz

Page 4-55, 2. Single Variable Resistors for General Use

	<u>Resister</u>	<u>Default Value</u>
<i>CHANGE</i>	ATR1	10 dB --> 20 dB
<i>CHANGE</i>	ATR2	10 dB --> 20 dB
<i>CHANGE</i>	ATT1	10 dB --> 20 dB
<i>CHANGE</i>	ATT2	10 dB --> 20 dB

Page 5-1, 2) General Purpose Resistors

<i>ADD</i>	RG, RH, RI, RJ
------------	----------------

Page 5-29 to 5-35-3, 5-13. HARD COPY

<i>DELETE</i>	Description of the color DUMP mode
---------------	---

Page 6-41, a) Real Type (32-bit) Resister Data

<i>ADD</i>	RG, RH, RI, RJ
------------	----------------

Page 6-46, Table 6-7

CHANGE

1. Data transfer rate using the **ENTER** command with an HP 9000 series 300 computer.

Code	Transfer Time		
	Model 310	Model 320	Model 350
FMT1	700 msec	540 msec	480 msec
FMT2	120 msec	80 msec	80 msec
FMT3	50 msec	40 msec	30 msec

2. Data transfer rate using the **TRANSFER** command with an HP 9000 series 300 computer.

Code	Transfer Time		
	Model 310	Model 320	Model 350
FMT2	70 msec	70 msec	70 msec
FMT3	30 msec	30 msec	30 msec

Page 7-21, Table 7-1, HARD COPY

DELETE Color DUMP Graphics mode

REMOTE PROGRAMMING, Data Transfer Rate(Typical):

Binary 32-bit	Approximately 40ms --> Approximately 30ms
Binary 64-bit	Approximately 90ms --> Approximately 70ms

Page B-1, APPENDIX B, ERROR MESSAGE AND INSTRUCTIONS

<i>DELETE</i>	Cal completed (TURN ON "CORR" KEY)	Is displayed when all data for calibration has been taken. Turn the ' CORRECTCN on off ' softkey to set the calibration function to on.
	Compen completed (TURN ON "CORR" KEY)	Is displayed when all data for compensation has been is taken. Turn the ' CORRECTCN on off ' softkey to set the compensation function to on.
<i>ADD</i>	<ul style="list-style-type: none"> • Isolation calibration completed • Load calibration completed • Open calibration completed • Short calibration completed measurement is completed. 	<p>Appears when the isolation calibration data measurement has been completed.</p> <p>Appears when the load calibration data measurement has been completed.</p> <p>Appears when the open calibration data measurement has been completed.</p> <p>Appears when short calibration data measure-</p>

- Thru calibration completed Appears when the **through** calibration data measurement is completed.
- 0S compensation completed Appears when the **0S** compensation data measurement has been completed.
- 0Ω compensation completed Appears when the **0Ω** compensation data measurement has been completed.

Page D-7, APPENDIX D, SOFTKEY TREE, **SPECIAL FUNCTION COPY** Softkey Tree

CHANGE

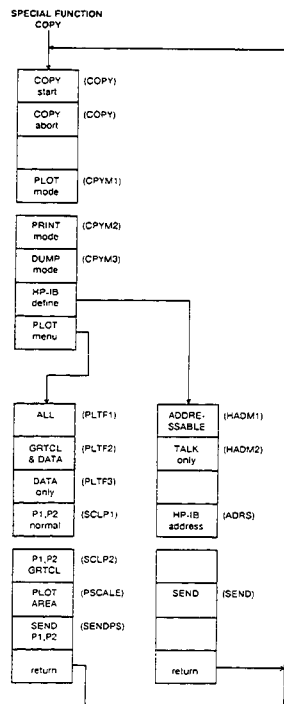

Page E-3, APPENDIX E, COMMAND LIST

DELETE **CPYM4**

Page F-2, APPENDIX F, RESISTER LIST, 2) GENERAL PURPOSE RESISTERS

ADD **RG, RH, RI, RJ**

APPENDIX B

ERROR MESSAGES AND INSTRUCTIONS

Appendix B lists the 4195A's error messages and instructions, with brief descriptions, in alphabetical order.

The 4195A displays error messages and instructions on the System Message Line to inform the user of error conditions, and to guide the user in the operation of the 4195A.

The error messages are displayed in **red**, and are listed in this appendix in **Bold** face type. The action that caused error will be ignored and the error will not affect the 4195A. Operation instructions are displayed in yellow, and are listed herein as normal (unbolded) type face.

NOTE

The black triangle (▶) and black bullet (●) indicate that Bit 5 (Error) and Bit 3 (End Status) of the HP-IB status byte are set, respectively, when the message is displayed. If the bit is enabled for SRQ (service request), Bit 6 (RQS) of the HP-IB status byte is also set. Refer to paragraph 6-5-7.

- A -

Message	Description
▶ Allowed only in IMPEDANCE	'CALC EQV para' softkey was pressed when the 4195A was not in the impedance mode. Equivalent circuit approximate value calculation may be performed only while in the Impedance configuration.
▶ Allowed only in IMPEDANCE/S11/S22	'EQV CKT' or 'SIMULATE f-char' softkey was pressed when the configuration was not impedance, S11, or S22. Equivalent circuit frequency response simulation may be performed only while in the Impedance, S11, or S22 configuration.
▶ Allowed only in Z- θ /Y- θ /R-X/G-B	'EQV CKT' or 'SIMULATE f-char' softkey was pressed when the impedance measurement parameter was not Z - θ , Y - θ , R-X, or G-B. When in impedance configuration, the equivalent circuit frequency response simulation can be performed only for the Z - θ , Y - θ , R-X, or G-B parameters. When in the S11 or S22 configuration any measurement parameter may be used.

A/B data stored into C/D

The 'STORE A,B→C,D' softkey was pressed. Trace data in A and B registers is stored in registers C and D.

▶ **A:RAM R/W err, adrs=ddddddH
err-bit=dddH**

Hardware failure. The 4195A will need to be repaired. Contact your nearest Hewlett-Packard office.

▶ **A:ROM allocation error**

Hardware failure. The 4195A will need to be repaired. Contact your nearest Hewlett-Packard office.

▶ **A:ROM check sum error, ID=dd**

Hardware failure. The 4195A will need to be repaired. Contact your nearest Hewlett-Packard office.

▶ **A:ROM combination mismatch**

Hardware failure. The 4195A will need to be repaired. Contact your nearest Hewlett-Packard office.

- B -

Message	Description
▶ Back up RAM data lost	The data in the battery back up RAM has been destroyed, and the RAM was initialized. The rechargeable battery may be discharged. Leave the 4195A on for two full days to allow the battery to fully recharge. If this message appears frequently at turn on, the battery or the charging circuit may be faulty. Contact your nearest Hewlett-Packard office.
▶ Bias must be -40 to +40 V	Attempted to enter a voltage value greater than ±40 V. The DC source voltage must be less than or equal to ±40 V.
BTM value has changed	Appears when a reference (top of scale) value less than or equal to the bottom value is entered. The bottom value was automatically changed in order to keep it less than the reference value.
▶ B:RAM R/W err, adrs=ddddddH err-bit=dddH	Hardware failure. The 4195A will need to be repaired. Contact your nearest Hewlett-Packard office.
▶ B:ROM allocation error	Hardware failure. The 4195A will need to be repaired. Contact your nearest Hewlett-Packard office.
▶ B:ROM check sum error, ID=dd	Hardware failure. The 4195A will need to be repaired. Contact your nearest Hewlett-Packard office.

► **B:ROM combination mismatch**

Hardware failure. The 4195A will need to be repaired. Contact your nearest Hewlett-Packard office.

- C -

Message	Description
Cal completed (TURN ON "CORR" KEY)	Is displayed when all data for calibration has been taken. Turn the ' CORRECTCN on off ' softkey to set the calibration function to on.
Compen completed (TURN ON "CORR" KEY)	Is displayed when all data for compensation has been is taken. Turn the ' CORRECTCN on off ' softkey to set the compensation function to on.
CAL must be done at first	Attempted to perform the 0S/0 Ω compensation data measurement before the calibration data measurement.
Calculating CAL coefficient	Is displayed when the ' CORRECTCN on off ' softkey was pressed, and is displayed until the calculation of the calibration coefficient is completed.
Calculating EQV parameters	Appears when the ' CALC EQV para ' softkey was pressed, and is displayed until the equivalent circuit approximation value calculation is completed.
Calculating f characteristics	Appears when ' SIMULATE f-char ' softkey was pressed, and is displayed until the equivalent circuit simulation calculation is completed.
Calculation complete	Appears when the equivalent circuit approximate value calculation or simulation calculation is completed.
Calibration aborted	Appears when the ' ABORT CAL ' softkey was pressed during calibration. The aborted calibration will not affect any previously taken calibration data.
Calibration data are interpolated	Appears when error compensation was performed with calibration data which was calculated using interpolation.
Calibration not allowed in SPECTRUM	Appears when the CAL key was pressed in the spectrum configuration. The Spectrum configuration does not have Calibration capability.

- ▶ **Calibration type mismatched** Appears when an unselected calibration was attempted.

- ▶ **Can't calculate EQV parameter** Appears when equivalent circuit parameters such as R, L, Ca, or Cb cannot be calculated.

- ▶ **Can't change in smith/polar display** Appears when you have attempted to change the display scale to Log when the display format was for a Smith or polar chart. Scale type (lin/log) cannot be changed while using the Smith and polar formats.

- ▶ **Can't change scale >20 times /sweep** Appears when you attempt to change scale parameters such as REF, DIV, or BTM more than 20 times in a sweep. Scale parameter can not be changed more than 20 times during a single sweep.

- ▶ **Can't change while data exist** Appears when an attempt was made to change the sweep point parameter when the sweep points had already been entered into the Program Point Table. Clear the table before changing it.

- ▶ **Can't measure τ in prog. point meas.** Appears when you have attempted to select the Group delay measurement while in a program point table measurement, or when a programmed point table measurement was attempted while making a group delay measurement. Group delay measurements cannot be performed using a program point table.

- ▶ **Can't print data on this display** The 'COPY start' softkey was pressed while the Equivalent Circuit Analysis display was on the screen and the PRINT mode was selected. The equivalent circuit analysis display can be dumped, but cannot be printed.

- ▶ **Can't select manual sweep** The 'MANUAL mode' softkey was pressed while in the Group Delay measurement mode. Manual sweep mode cannot be used for group delay measurements.

- ▶ **Change parameter to Z- θ /Y- θ** The 'CALC EQV para' softkey was pressed when the configuration was impedance and the measurement parameter selected was not |Z|- θ or |Y|- θ . Equivalent circuit approximate value calculation can be performed only for the |Z|- θ and |Y|- θ parameters.

- ▶ **Change sweep to frequency**
Attempted to use Equivalent Circuit Analysis when the sweep parameter was not frequency. Equivalent Circuit Analysis can only be used when the sweep parameter is frequency.
- ▶ **Command syntax error**
Command syntax used is not correct. Refer to the command syntax diagram.
- ▶ **Compen allowed only in impedance**
An offset compensation command was executed when the configuration was not impedance. Offset compensation may be used only in the impedance configuration.
- ▶ **Compen type mismatched**
Appears when an attempt was made to perform an unselected compensation. For example, the **ZOCMP** command was executed when the '**COMPEN NONE**' softkey was selected.
- Compensation aborted
Appears when the '**ABORT COMPEN**' softkey was pressed during compensation. The aborted compensation will not affect any previously taken compensation data.
- Copy aborted
Appears when '**COPY abort**' softkey was pressed while a hardcopy was in progress.
- Copy completed
Appears when a hardcopy operation was completed.

- D -

Message	Description
▶ Delay aperture 0.5 to 100 %	A delay aperture value out of settable range was entered. The delay aperture must be set between 0.5 and 100.
▶ Directory overflow	Although there may have been room on the the media for the file, there was no room in the directory for another file name. A maximum of 192 files may be stored on a disc.
▶ Disc not in drive	One of the disc drive access softkeys was pressed when there was no disc is in the drive. Insert a 3-1/2 inch micro flexible disc.
▶ DISP syntax error	Syntax error existed in the DISP command executed.

DIV value has changed	Appears when display scale division has changed automatically in order to keep the REF/BTM relation.
▶ Divide by zero error	Divide by zero math error.
▶ Down sweep not allowed in SPECTRUM	The 'DIRECTN up down' softkey was pressed to select down sweep direction while in the spectrum configuration.
▶ Duplicate file name	The specified file name already exists in the directory. It is illegal to have two files with the same name on the same volume.

- E -

Message	Description
▶ EEPROM check sum error	Hardware failure. The 4195A needs to be repaired. Contact your nearest Hewlett-Packard office.
▶ END statement not found	Appears when an User Program (ASP) execution reached the last line without finding the BASIC END statement.
ENTER to execute ALL CLEAR	Appears when the 'TABLE ALL CLR' softkey was pressed. Confirm that you really want to clear the table, then press ENTER/EXECUTE key to complete this operation.
ENTER to execute FORMAT DISC	Appears when the 'format DISC' softkey was pressed. Confirm that you really want to initialize the disc, then press ENTER/EXECUTE key to initiate this operation.
Exit editor	Appears when the 'QUIT editor' softkey was pressed to notify you that you have exited the User Program (ASP) editor.
Exit programmed points table	Appears when the 'set end' softkey was pressed to notify you that you have exited the Programmed Point Table editor.
Exit UDF editor	Appears when the 'EXIT UDF edit' softkey was pressed to notify you that you have exited the User Defined Function or Sweep End Function.

- F -

Message	Description
▶ File name is undefined	The specified file name does not exist in the directory. Check the contents of the disc with the CAT (catalog) command.
▶ FOR NEXT syntax error	User Program (ASP) BASIC statement construct, FOR...TO...NEXT syntax error. If this construct is nested more than ten deep, this error will also occur.
▶ FORMAT failed	Too many bad tracks found. The disc was defective, damaged, or dirty. Appears when disc formatting (initialization) failed.
▶ Fractional N loop unlocked	Hardware failure. The 4195A will need to be repaired. Contact your nearest Hewlett-Packard office.
▶ Freq. must be 0.001 to 500M Hz	Attempted to enter a frequency value lower than 1 mHz or higher than 500 MHz. The range of frequencies which may be entered is 1 mHz to 500 MHz.
Frequency span is out of calibrated range	Appears when the frequency setting is out of the calibrated frequency range.

- G -

Message	Description
▶ Get failed	Check sum error occurred while attempting to GET a file.
▶ GOSUB RETURN syntax error	User Program (ASP) BASIC statement construct, GOSUB...RETURN syntax error. If this construct is nested more than 10 deep, this error message will also occurred.
▶ GOTO syntax error	User Program (ASP) BASIC statement, GOTO syntax error.

- H -

Message	Description
▶ HP-IB char string too long	The character string sent via HP-IB was greater than the 2048 Byte limit.

- 1 -

Message	Description
▶ IF THEN syntax error	User Program (ASP) BASIC statement, IF...THEN syntax error. If this construct is nested more than 10 deep, this error message will also occur.
▶ Improper definition in sweep end fctn	The sweep end function definition was improper.
▶ Improper delimiter	Syntax error. Delimiters such as semicolon (;), carriage-return/line-feed (CR/ LF), or comma (,) were used improperly or no delimiter was detected.
▶ Improper entry unit	Setting error. Unit key such as Hz, V, dBm, or dBμV is used improperly.
▶ Improper file name.(A→Z & _ only)	Improper file name was used when getting or saving the file from/to flexible disc. Only upper-case characters (A to Z), numbers, and underscores (_) may be used.
▶ Improper file type	The 4195A can only GET ASP, PPT, DATA, STATE type files from a disc. Some ASCII and BDAT files can be read from the disc, if they are identical to ASP and DATA files, respectively. The file type can be determined by executing the CAT command.
▶ Improper math definition	The user defined math definition was improper.
▶ Improper numeric expression	Numeric expression is improper. For example, CENTER=1.0.0MHZ was executed.
▶ Improper scale value	Scale value setting error. For example, negative value was used for DIV, or zero was used for the log scale.
Input buffer full	The character string entered on the keyboard input line exceeded 88 characters.
▶ INPUT syntax error	Syntax error existed in the INPUT command executed.
▶ Integer overflow	Appears when the result of integer calculation overflows. The integer value range is from -2147483648 to +2147483647. Refer to descriptions of binary math operators.

▶ Invalid LOG/LN argument	The LOG or LN math operator was used improperly.
▶ Invalid mass storage volume label	Usually indicates that the media was not initialized on a compatible system. Could also be a bad disc.
▶ Invalid parameter range	Attempted to enter an out of range value. For example, 100 was entered as an input attenuator setting.
▶ Invalid prog. points table	Program points table is turned on or program table number was changed when the table was invalid. For example, the oscillator level selected for program points and -15 dBm and +15 dBm was registered in the same table.
▶ Invalid select code number	Input error. The number selected was wrong for the type of command selected. For example, selecting a number greater than or equal to 8 for the Configuration Select Command (FNC1 through FNC7) is executed.
▶ Invalid SIN/COS argument	Math operator SIN or COS was improperly used.
▶ Invalid SQR argument	Math operator SQR was improperly used.
Invalid step parameter	The up or down arrow key was pressed when the changeable parameter was not displayed on the keyboard input line.
ISOLATION CAL required	Appears when isolation calibration data measurement is required.

- J -

There are no messages beginning with J.

- K -

There are no messages beginning with K.

- L -

Message	Description
▶ Line cursor not displayed	A command that uses the line cursor was executed when the line cursor was not displayed.
▶ Line number not found	Branch destination of User Program (ASP) GOTO , GOSUB , or THEN statement was not found.

- ▶ **Line number syntax error**
Syntax error found related to the line number in the User Program (ASP). For example, no character space between the line number and the statement.
- LOAD CAL required
Appears when the load calibration data measurement is required.
- ▶ **LOG sweep not allowed in OSC_dB**
Log sweep type cannot be selected for oscillator level (dBm or dB μ V) sweep.

- M -

Message	Description
▶ Markers not displayed	A command that uses a marker was executed when no marker was displayed.
▶ Mass storage hardware failure	The disc drive hardware failure was detected during disc access. Also occurs when the disc was pinched and not turning. Try reinserting the disc.
▶ Mass storage medium overflow	There is not enough contiguous free space for the specified file size. The disc is full.
Measured data are stored in MA reg.	Appears when 'DEFINE MATH A' softkey is pressed.
Measured data are stored in MB reg.	Appears when 'DEFINE MATH B' softkey is pressed.
Measuring ISOLATION	Appears during isolation calibration data measurement.
Measuring LOAD	Appears during load calibration data measurement.
Measuring OPEN	Appears during open calibration data measurement.
Measuring THRU	Appears during through calibration data measurement.
Measuring SHORT	Appears during short calibration data measurement.
Measuring OS	Appears during OS offset compensation data measurement.
Measuring 0 Ω	Appears during a 0 Ω offset compensation data measurement.
Memory full	Appears when the total number of program lines in the User Program (ASP) work area exceeds 300 lines.

- | | |
|--|---|
| <p>▶ Memory full(all boxes used)</p> <p>Memory test in progress</p> | <p>Attempted to fill another program point table when there was no room for the program points table.</p> <p>Appears during the power on memory test.</p> |
| <p>▶ Min. Resolution<=STEP<=SPAN</p> | <p>An attempt was made to enter a step value less than the settable minimum resolution or greater than the current set span value.</p> |
| <p>▶ Multi statement not allowed</p> | <p>Command or User program (ASP) BASIC statement designed as single statement type was used in the multi statement form.</p> |
| <p>▶ Must be 0<= SPAN <=full range</p> | <p>Attempted to enter a span value less than 0 or more than the full range (for example, 499 999 999.999 Hz in frequency sweep mode).</p> |

- N -

Message	Description
<p>▶ Negative data exists in A_REG</p>	<p>The 'CALC EQV para' softkey was pressed when one or more negative data exist in the A register. When performing the equivalent circuit approximate value calculation, data in A register must be non-negative. (Normally measured Z or Y values are stored in the A register. So never enter negative values for the circuit parameters.)</p>
<p>▶ N must be >= 2 in ana. range</p>	<p>The 'STORE ANA RNG' softkey was pressed when the o and * markers are at the same point. The number of points for the partial analysis range (between o & * markers) must be greater than or equal to 2.</p>
<p>▶ N must be >= 3 in ana. range</p>	<p>An attempted was made to use Equivalent Circuit Analysis when the number of points in the analysis range was less than 3.</p>
<p>▶ N must be >= 2 in sweep range</p>	<p>The 'STORE SWP RNG' softkey was pressed when the o and * markers were at the same point. Number of measurement points for partial sweep range (between o & * markers) must be greater than or equal to 2.</p>

No action has taken	Key other than the ENTER/EXECUTE key was pressed when ENTER to execute ALL CLEAR or ENTER to execute FORMAT DISC was displayed on the system message line.
▶ No ASP program in memory	Attempted to RUN or SAVE a program, when no program was in the User Program (ASP) work area.
▶ No calibration type selected	The ' CORRECTN on off ' softkey was pressed to turn on the correction when ' CAL NONE ' or ' COMPEN NONE ' was selected.
▶ NOISE allowed only in SPECTRUM	The ' NOISE on off ' softkey was pressed to turn on the noise mode when in other than the spectrum configuration.
▶ NOP must be 2 to 401	An attempt was made to enter a number of measurement points (NOP) value less than 2 or more than 401.
▶ Not allowed in ASP	A invalid User Program (ASP) command was used the program. For example, UDF1 is programmed in a User Program (ASP).
▶ Not allowed in LOG scale	Scale division cannot be set when the display is set to the Log scale mode.
▶ Not allowed in LOG sweep	The CENTER , SPAN , or STEP values cannot be set when Log sweep is selected.
▶ Not allowed in manual sweep	The ' θ DISP expand ' softkey was pressed while in the Manual sweep mode.
▶ Not allowed in present state	A command that cannot be use in the current settings is executed.
▶ Not allowed in prog. measure	A command that will change the sweep parameter settings was executed while a programmed points measurement was being performed.
▶ Not allowed in SMITH display	The ' MKR→REF ' softkey was pressed while the Smith display format was selected.
Not allowed in user define function	A softkey in the User Program editor (except for the DISP command) was pressed.

▶ Not allowed in Zero Span

The 'MKRS→SPAN' softkey was pressed or an attempt to use Equivalent Circuit Analysis when a zero span measurement was being made.

Not calculate τ in Zero span

Group delay measurement cannot be selected while in the zero frequency span mode.

▶ Not continuable

The 'CONT' softkey was pressed while a User Program (ASP) was in the STOP status. This command is effective only during the PAUSE state.

▶ Not in o & * MKRS mode

A command which uses the o and * markers was executed when the o and * markers were not displayed.

Not in PLOT mode

Appears when 'PLOT menu' softkey was pressed when the hardcopy mode was not set to the PLOT mode.

▶ Number of points full

Number of sweep points set in a programmed points table exceeded 401.

- O -

Message	Description
▶ Only FREQ & LIN swp allowed in τ meas	Group delay measurement can be performed only when the sweep parameter is frequency and the sweep type is linear.
Open CAL required	Appears when an open calibration data measurement is required.
▶ Osc must be -50 thru +15 dBm	Attempted to enter an oscillator level value of less than -50 dBm or greater than +15 dBm. Setting error, the source amplitude must be set between -50 dBm and +15 dBm.
▶ Osc must be 57 to 122 dB μ V	Attempted to enter an oscillator level value of less than 57 dB μ V or greater than 122 dB μ V. The source amplitude must be set between +57 dB μ V and +122 dB μ V.
▶ Osc must be 707 μ to 1.26 V	Attempted to enter an oscillator level value of less than 707 μ V or greater than 1.26 V. The source amplitude must be set between 707 μ Vrms and 1.26 Vrms.
Out of line numbers	Appears when a program line number less than 1 or greater than 32767 was used.

- ▶ **Out of range in SWEEP POINTS** Sweep point set in the programmed points table was out range.
- ▶ **Out of range (1E-37 → 9.99999E+37)** Setting error. Setting range for the registers must be 0 or ±1E-38 to ±9.99999E+37. Check the register setting range listed in Appendix F.
- ▶ **OUTPUT syntax error** Syntax error existed in the OUTPUT command.
- ▶ **Overload on R1 input** Input signal amplitude at R1 input connector exceeds the input range value.
- ▶ **Overload on R2 input** Input signal amplitude at the R2 input connector exceeds the input range value.
- ▶ **Overload on T1 input** Input signal amplitude at T1 input connector exceeds the input range value.
- ▶ **Overload on T2 input** Input signal amplitude at T2 input connector exceeds the input range value.

- P -

Message	Description
▶ Plot allowed X-A&B/A-B/SMITH/POLAR	Plot mode hardcopy cannot be made other than X-A&B, A-B, Smith, and polar display format.
Press ENTER to start isolation calibration	Appears when the 'ISOLATN' softkey was pressed. Confirm that isolation connection has been made and then press the ENTER/EXECUTE key.
Press ENTER to start load calibration	Appears when the 'LOAD' softkey was pressed. Confirm that load connection has been made and then press the ENTER/EXECUTE key.
Press ENTER to start open calibration	Appears when the 'OPEN' softkey was pressed. Confirm that open connection has been made and then press the ENTER/EXECUTE key.
Press ENTER to start short calibration	Appears when the 'SHORT' softkey was pressed. Confirm that short connection has been made and then press the ENTER/EXECUTE key.
Press ENTER to start thru calibration	Appears when the 'THRU' softkey was pressed. Confirm that through connection has been made and then press the ENTER/EXECUTE key.

Press ENTER to start OS compensation	Appears when the 'OS' softkey was pressed. Confirm that the OS connection has been made and then press the ENTER/EXECUTE key.
Press ENTER to start OΩ compensation	Appears when the 'OΩ' softkey was pressed. Confirm that the OΩ connection has been made and then press the ENTER/EXECUTE key.
▶ Programmed points table empty	Attempted to use program point measurement, when no sweep points are entered in the programmed points table.
Prog.points measure aborted	Appears when the programmed points measurement was aborted by changing the settings in the program point table.
▶ Protect code violation	Appears when an attempt was made to get a protected file from a disc.

- Q -

There are no messages beginning with Q.

- R -

Message	Description
▶ Read data error	The media is physically or magnetically damaged, and the data cannot be read.
▶ Real math overflow	Overflow has occurred during a 64-Bit floating point computation.
▶ Real math underflow	Underflow has occurred during a 64-Bit floating point computation.
▶ Record address error	Usually indicates a problem with the storage media.
▶ Record not found	Usually indicates that the storage media has not been initialized.
▶ RECOVER failed	Failed to recover a purged file, or there is no file that can be recovered.
▶ Recursive call not allowed	Appears when an attempt is made to recursively call a User Defined Function.
REF value has changed	Display scale REF value was automatically changed order to keep it greater than thee BTM value.

- S -

Message	Description
▶ Select o marker mode	A command which uses the o marker was executed while the o marker is not displayed.
Send P1,P2 to PLOTTER	Appears when the ' SEND P1,P2 ' softkey is pressed and the data has been transferred to the plotter.
Short CAL required	Appears when a short calibration data measurement is required.
▶ Sign must be same in LOG sweep	Attempted to enter the LOG sweep mode when the START and STOP values are of different polarity.
▶ Smith/polar display not allowed	' SMITH ' or ' POLAR ' softkey is pressed while in the Spectrum or Impedance configuration.
▶ SPAN must be within 26dB in OSC sweep	Attempted to enter a SPAN value greater than 26 dB (or approximately 20 times) when in the oscillator level sweep mode. When in the oscillator level sweep mode, the sweep span must be less than or equal to 26 dB.
▶ Statement too complex	The statement used in an User Program (ASP) was too complex to calculate.
▶ STEP > SPAN error	Setting error. The STEP value was set larger than the SPAN value while in the Linear sweep mode.
▶ String buffer full	While in an ASP program the number of characters on a program line exceeded 88 characters.
▶ Subscript out of range	An element number less than 1 or greater than 401 was specified when specifying an element of an array register. For example, A(0) is executed on the keyboard input line.
▶ Sweep parameter mismatching	The ' X REG DMP to TBL ' or ' X REG dump ' softkey was pressed when sweep parameter in the X register and the currently set program point sweep parameter are not the same.

- ▶ **Sweep point required in freq table**
Appears only when resolution bandwidth data was entered using the **POINT=** command while the program point sweep parameter is frequency. For example, **POINT=,300K** is executed. This syntax can be used for other than frequency sweep.
- ▶ **Syntax error in RBW value**
Syntax error existed in the resolution bandwidth entry for the programmed points table.
- ▶ **Syntax error in SWEEP POINTS**
Syntax error existed in the sweep point entry for the programmed points table.

- T -

Message	Description
The same sweep point exists	Appears when an attempt is made to enter the same sweep point into a programmed points table. Resolution Bandwidth value is updated, if it is entered.
THRU CAL required	Appears when a through calibration data measurement is required.
Toggle type (DEG & RAD appears alternately)	Appears when the ' PHS UNIT deg rad ' softkey was pressed in the program editor mode.
Toggle type (MHZ & V appears alternately)	Appears when the MHz/V key was pressed in the program editor mode.
Toggle type (KHZ & DBM appears alternately)	Appears when the kHz/dBm key was pressed in the program editor mode.
Toggle type (HZ & DBUV appears alternately)	Appears when the Hz/μV key was pressed in the program editor mode.

- U -

Message	Description
UDF editor aborted	Appears when ' EXIT UDF edit ' softkey was pressed while in the User Defined Function Editor mode.

UDF EDITOR (Press ENTER to end definition) Appears when you enter the User Defined Function editor. Press the **ENTER/EXECUTE** key to complete the definition and exit from the editor. Press the **'EXIT UDF edit'** softkey to not update the definition and exit from the editor.

▶ **Undefined symbol** Undefined symbol was detected. Check the 4195A commands, register manes, suffix or math operators.

Unit is cm Appears when one of the port extension length entry softkeys is pressed.

Unit is msec Appears when the **'WAIT'** softkey was pressed. The WAIT time is set in units of milliseconds.

Unit is % of frequency span Appears when the **'APERTURE entry'** softkey was pressed.

- V -

Message

Description

▶ **Value range error** Setting error. Value set for math operator was improper.

- W -

Message

Description

▶ **WAIT syntax error** User Program (ASP) BASIC statement, **WAIT** syntax error.

▶ **Write protected** Attempted to write to a write-protected disc.

▶ **Write to read only resistor** Attempted to write to a read-only type register.

- X -

There are no messages beginning with X.

- Y -

There are no messages beginning with Y.

- Z -

Message	Description
▶ Zero to negative power	Exponentiation error, tried to perform a $0^{**}(\text{negative value})$ calculation.

- Others -

Message	Description
0S compen required	Appears when an 0S compensation data measurement is required.
0Ω compen required	Appears when an 0Ω compensation data measurement is required.
50Ω=1, 75Ω=2	Appears when the ' Z0 50Ω 75Ω ' softkey was pressed while in the program editor mode.
θ expand mode has released	Appears when the manual sweep mode was selected while in the phase scale expansion mode. The phase expansion measurement mode cannot be selected in the manual sweep mode.
oMKR=1 , LCRS=0	Appears when the ' active oMKRLCURS ' softkey was pressed while in the program editor mode.
oMKR=1 , *MKR=0	Appears when the ' active oMKR*MKR ' softkey was pressed while in the program editor mode.

NOTES

APPENDIX C

ERROR NUMBERS

Appendix C lists the HP 4195A error messages in numerical order. When an error occurs the error number will be stored in the ERR register, and can be read via HP-IB using the **ERR?** command or by front panel key operation. For details about the error message meanings, refer to Appendix B. The action that caused error will be ignored and the error will not affect the 4195A.

When the 4195A is in the HP-IB remote mode, most of the error messages will set Bit-5 (Error) and the RQS bit of the HP-IB Status Byte. Use the **RQS** command to mask these bits if needed.

Number	Error Message
0	Input buffer full
1	Back up RAM data lost
2	EEPROM check sum error
3 to 9	<i>not assigned</i>
10	Undefined symbol
11	Improper numeric expression
12	Out of range (1E-37 → 9.99999E+37)
13	Improper delimiter
14	Command syntax error
15	Invalid select code number
16	Invalid parameter range
17	Not allowed in LOG sweep
18	LOG sweep not allowed in OSC_dB
19	NOP must be 2 to 401
20	Not allowed in ASP
21	Recursive call not allowed
22	Freq. must be 0.001 to 500M Hz
23	Zero to negative power
24	Osc must be -50 thru +15 dBm Osc must be 57 to 122 dB μ V Osc must be 707 μ to 1.26 V
25	SPAN must be within 26dB in OSC sweep
26	Bias must be -40 to +40 V
27	Improper entry unit
28	Sign must be same in LOG sweep
29	Down sweep not allowed in SPECTRUM
30	Improper definition in sweep end fctn
31	Min. Resolution \leq STEP \leq SPAN
32	STEP > SPAN error
33	Write to read only register
34	Improper math definition
35	Not allowed in Zero Span

36	Not allowed in present state
37	Can't select manual sweep
38	<i>not assigned</i>
39	Must be $0 \leq \text{SPAN} \leq \text{full range}$
40	Not allowed in SMITH display
41	Multi statement not allowed
42	Subscript out of range
43	Delay aperture 0.5 to 100 %
44	Only FREQ & LIN swp allowed in τ meas
45	Can't measure τ in prog. point meas.
46	Can't change in smith/polar display
47	Not allowed in LOG scale
48	Improper scale value
49	Not allowed in manual sweep
50	Not allowed in prog. measure
51	Statement too complex
52 to 59	<i>not assigned</i>
60	Smith/polar display not allowed
61	N must be ≥ 2 in sweep range
62	N must be ≥ 2 in ana. range
63	Not in o & * MKRS mode
64	Markers not displayed
65	Line cursor not displayed
66	NOISE allowed only in SPECTRUM
67 to 69	<i>not assigned</i>
70	Can't change scale >20 times /sweep
71	Select o marker mode
72 to 79	<i>not assigned</i>
80	Compen allowed only in impedance mode
81	Calibration type mismatched
82	Compen type mismatched
83	No calibration type selected
84 to 99	<i>not assigned</i>
100	Can't change while data exist
101	Memory full(all boxes used)
102	Number of points full
103	Sweep parameter mismatching
104	Syntax error in SWEEP POINTS
105	Syntax error in RBW value
106	Sweep point required in freq table
107	Programmed points table empty
108	Invalid prog. points table
109	Out of range in SWEEP POINTS
110	Out of range in real part
111	Out of range in imag part
112 to 119	<i>not assigned</i>
120	String buffer full
121	Line number syntax error
122 to 139	<i>not assigned</i>
140	No ASP program in memory
141	Not continuable
142	WAIT syntax error
143	GOTO syntax error
144	IF THEN syntax error
145	FOR NEXT syntax error
146	GOSUB RETURN syntax error

	147	DISP syntax error
	148	OUTPUT syntax error
	149	INPUT syntax error
	150	Line number not found
	151	END statement not found
152 to	159	<i>not assigned</i>
	160	HP-IB char string too long
	161	Plot allowed X-A&B/A-B/SMITH/POLAR
	162	Can't print data on this display
163 to	179	<i>not assigned</i>
	180	Overload on R1 input
	181	Overload on T1 input
	182	Overload on R2 input
	183	Overload on T2 input
	184	Fractional N loop + unlocked
	185	Fractional N loop - unlocked
186 to	189	<i>not assigned</i>
	190	Mass storage hardware failure
	191	Record not found
	192	Read data error
	193	Write protected
	194	Disc not in drive
	195	FORMAT failed
	196	Directory overflow
	197	Mass storage medium overflow
	198	Duplicate file name
	199	Improper file type
	200	File name is undefined
	201	Protect code violation
	202	Invalid mass storage volume label
	203	RECOVER failed
	204	Record address error
	205	Improper file name.(A→Z & _ only)
	206	Improper data exist
	207	Get failed
208 to	219	<i>not assigned</i>
	220	Allowed only in IMPEDANCE/S11/S22
	221	Change parameter to Z- θ /Y- θ
	222	Change sweep to frequency
	223	N must be ≥ 3 in ana. range
	224	Allowed only in IMPEDANCE
	225	Negative data exists in A_REG
	226	Can't calculate EQV parameter
	227	Allowed only in Z- θ /Y- θ /R-X/G-B
	228	Integer overflow
	229	Divide by zero error
	230	Real math overflow
	231	Real math underflow
	232	Value range error
	233	Invalid SIN/COS argument
	234	Invalid LOG/LN argument
	235	Invalid SQR argument
	236	<i>not assigned</i>
237 to	241	<i>Error numbers 237 through 241 are only related to the HP 4195A service functions. They will not appear in normal user operation.</i>

NOTES

APPENDIX D

SOFTKEY TREE

Appendix D shows the 4195A's softkey tree. The corresponding command codes are given in parenthesis beside the softkey label. The conditions to display a set of softkey labels are enclosed in brackets at the top of a block of softkeys.

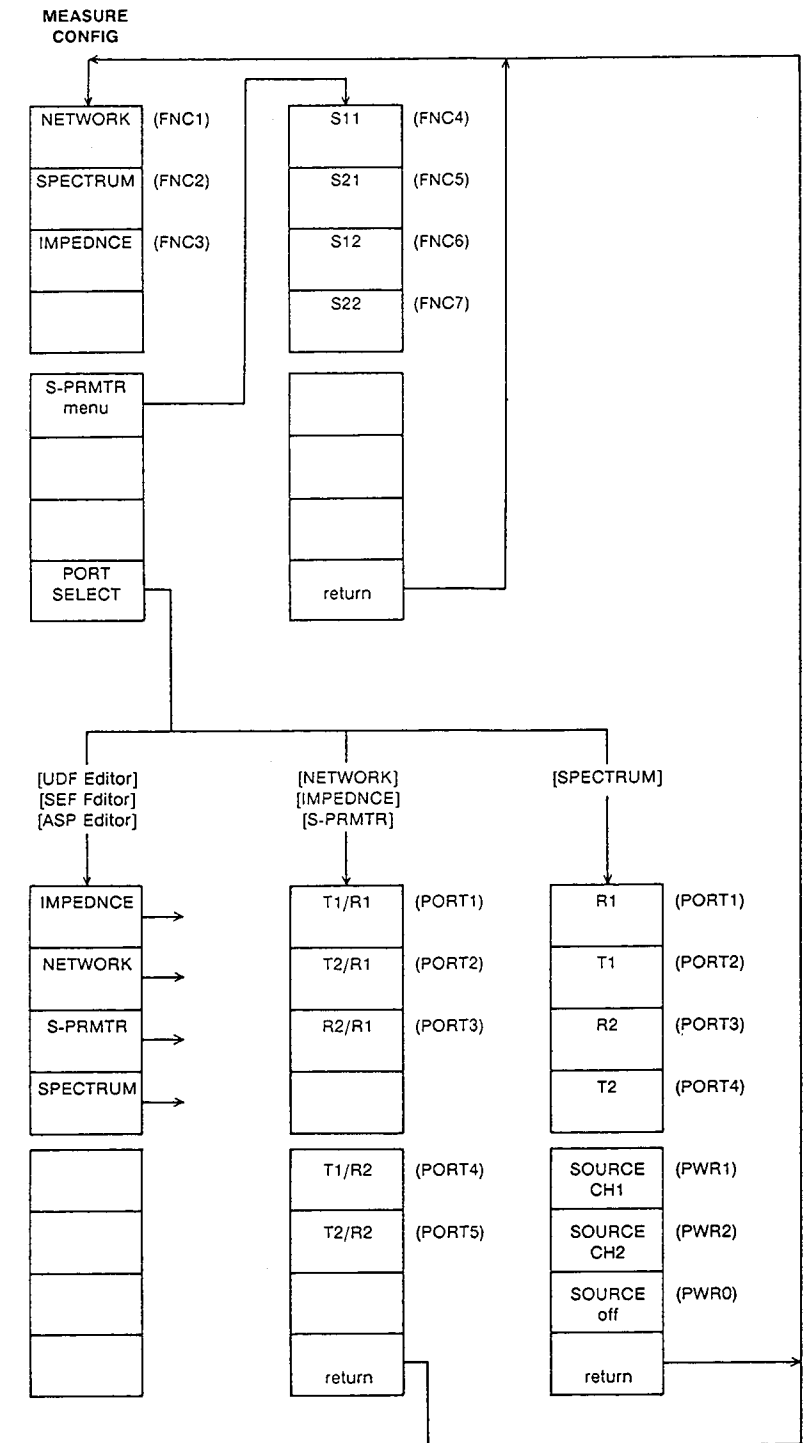

MEASURE CONFIG Softkey Tree

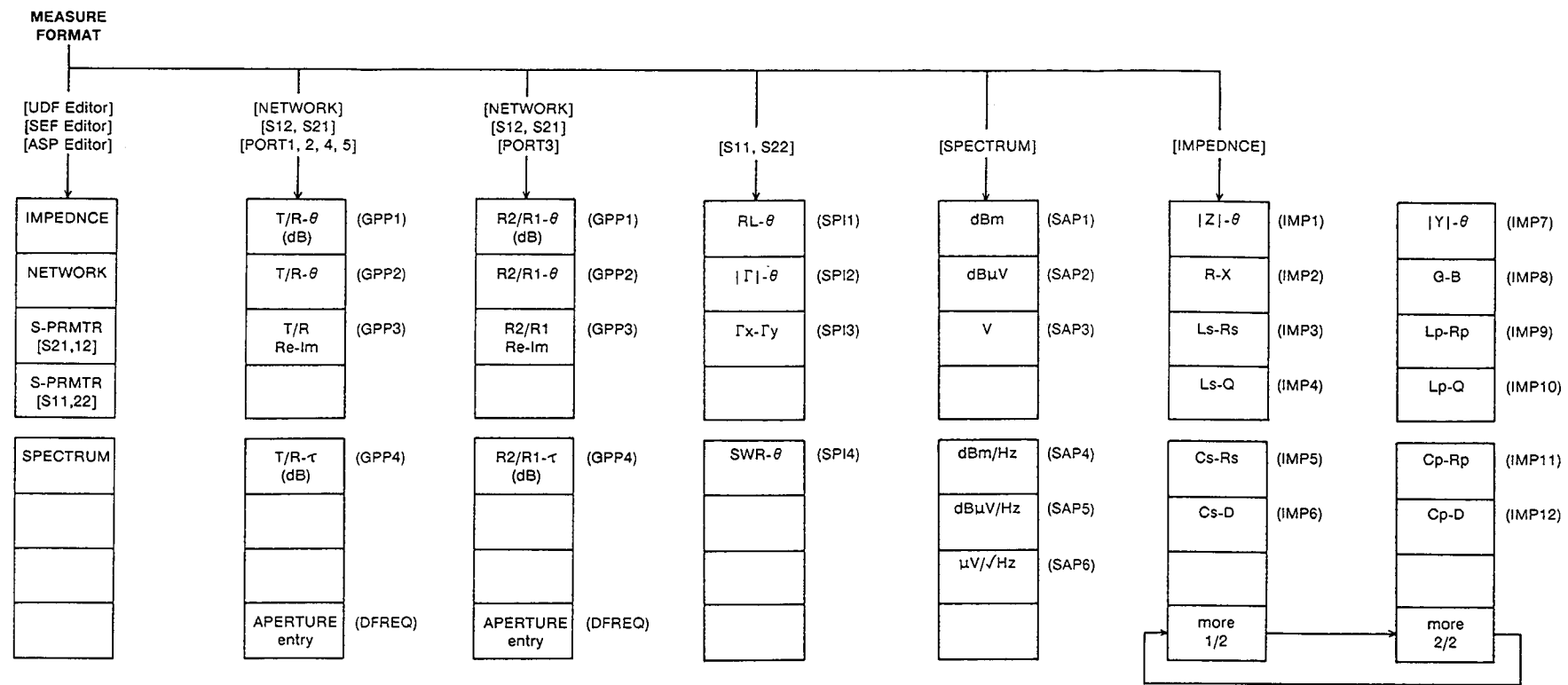

MEASURE FORMAT Softkey Tree

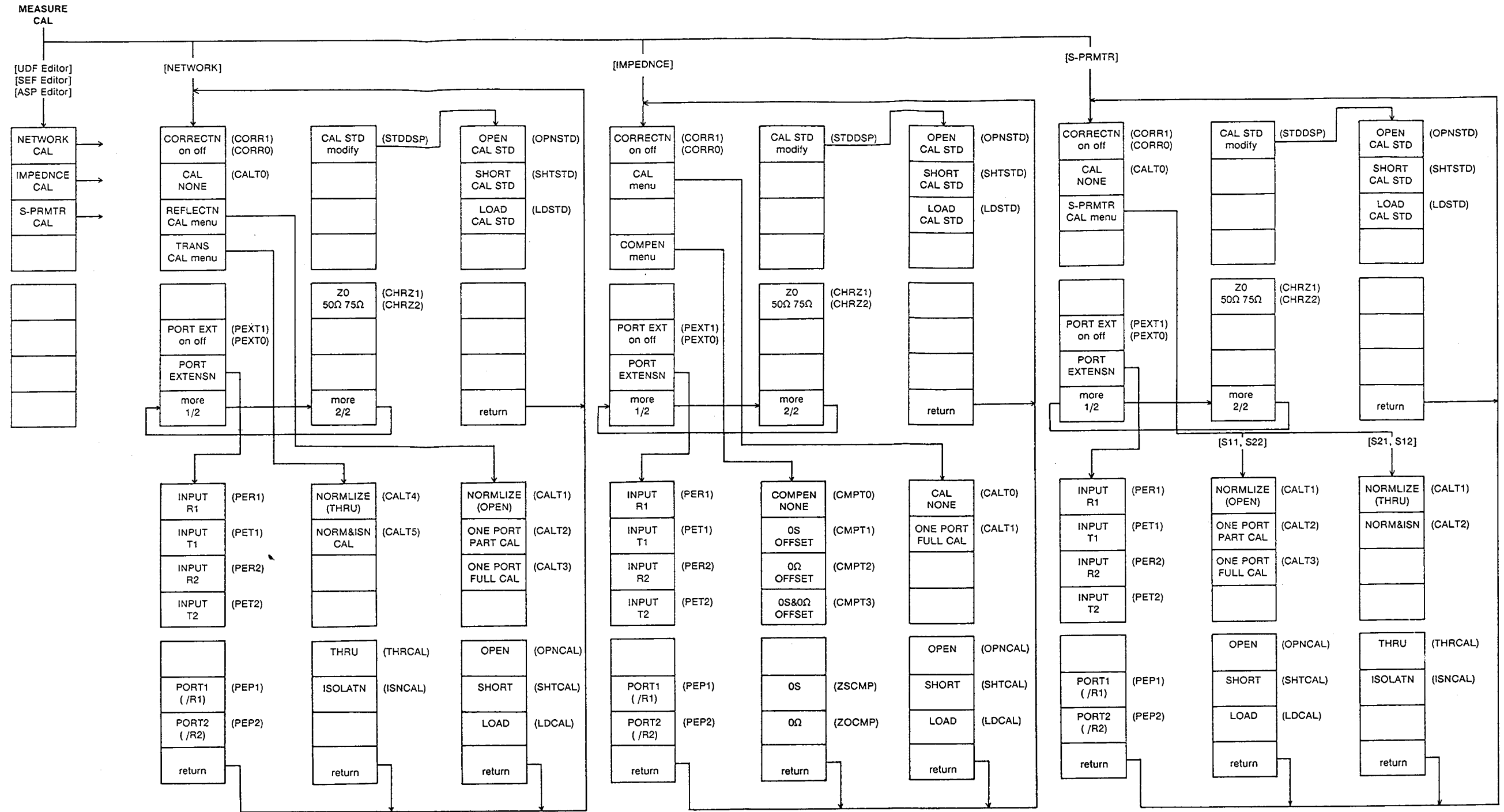

MEASURE CAL Softkey Tree

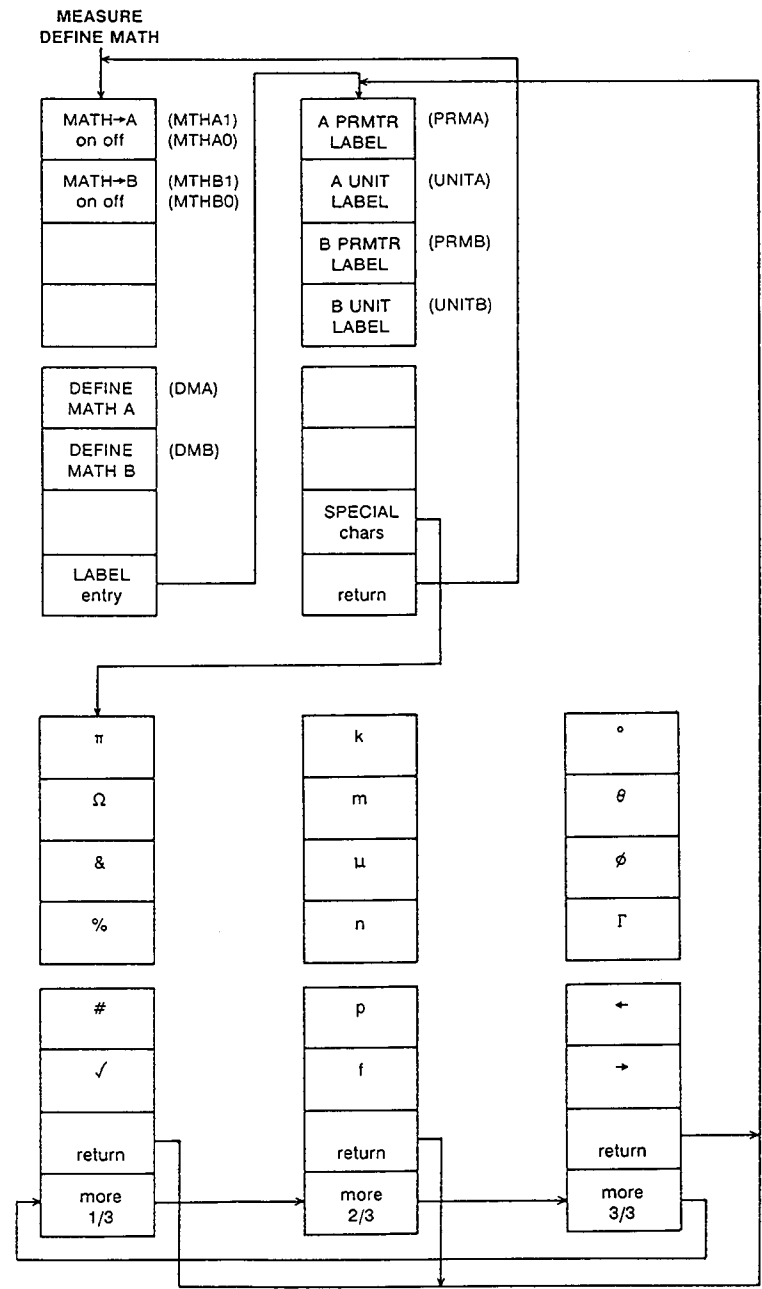

MEASURE DEFINE MATH Softkey Tree

**SPECIAL FUNCTION
USER DEFINE**

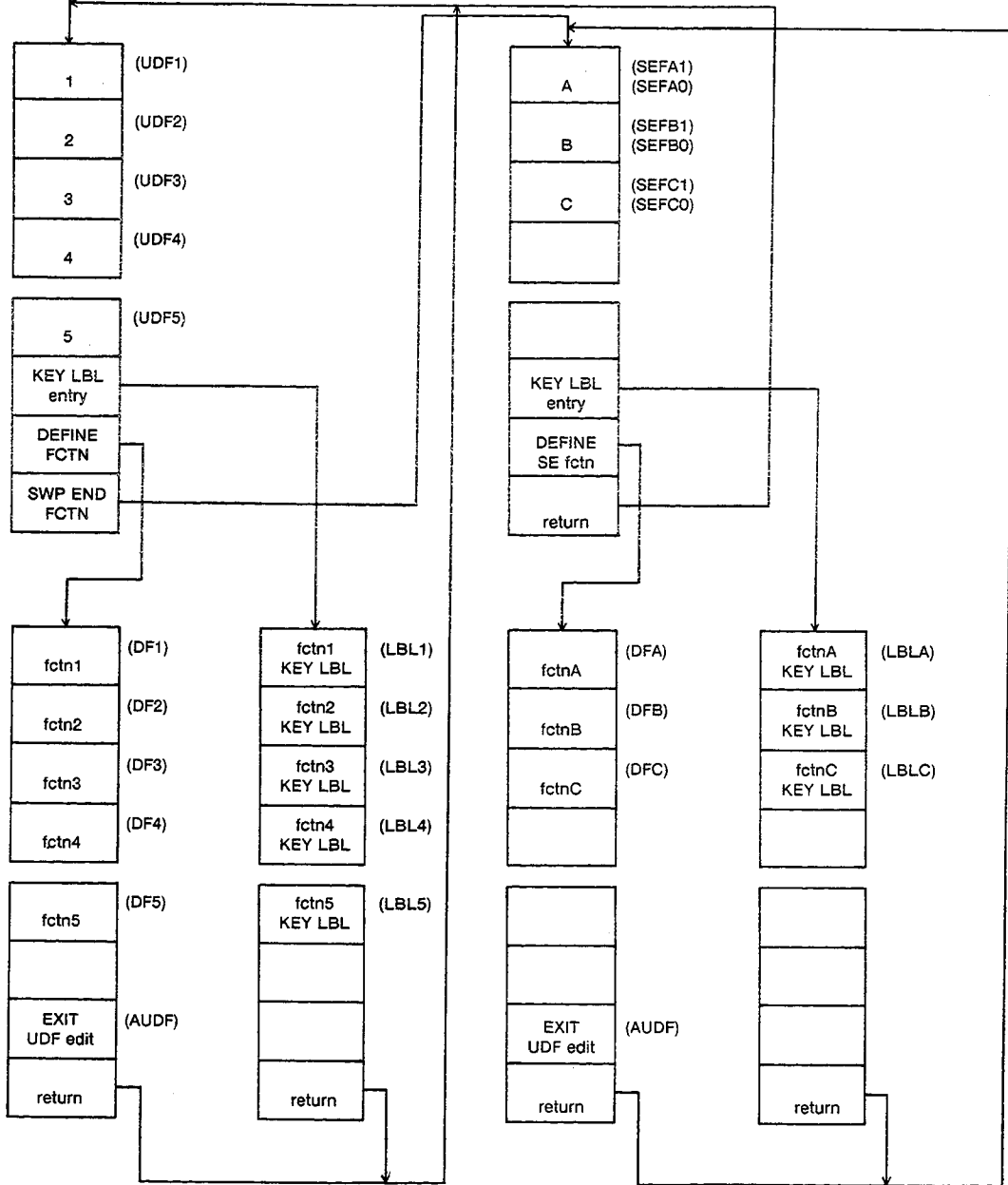

SPECIAL FUNCTION USER DEFINE Softkey Tree

**SPECIAL FUNCTION
SAVE/GET**

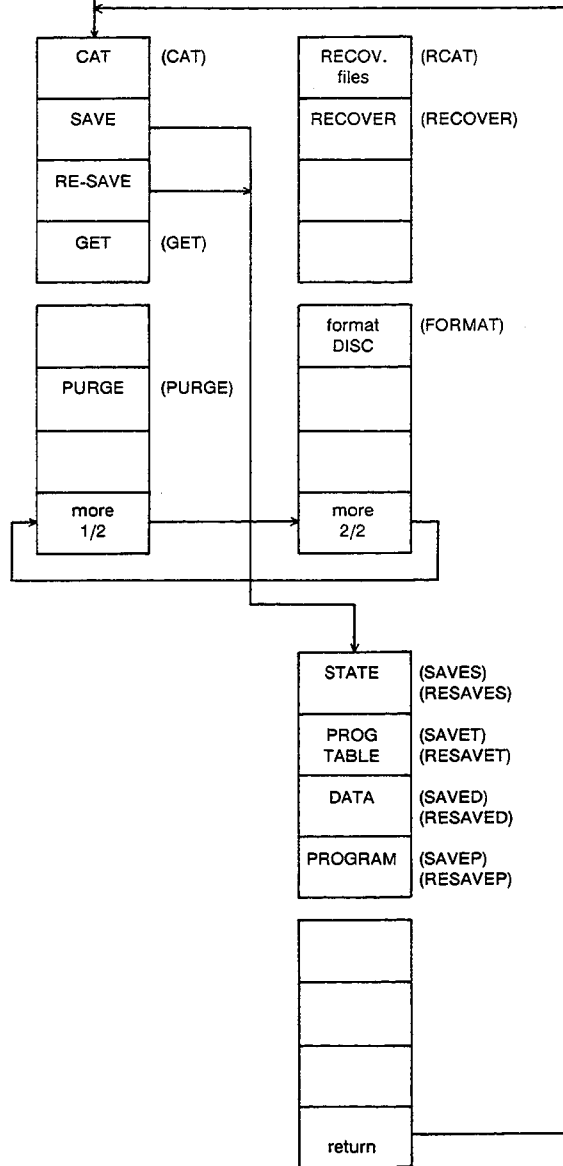

SPECIAL FUNCTION SAVE/GET Softkey Tree

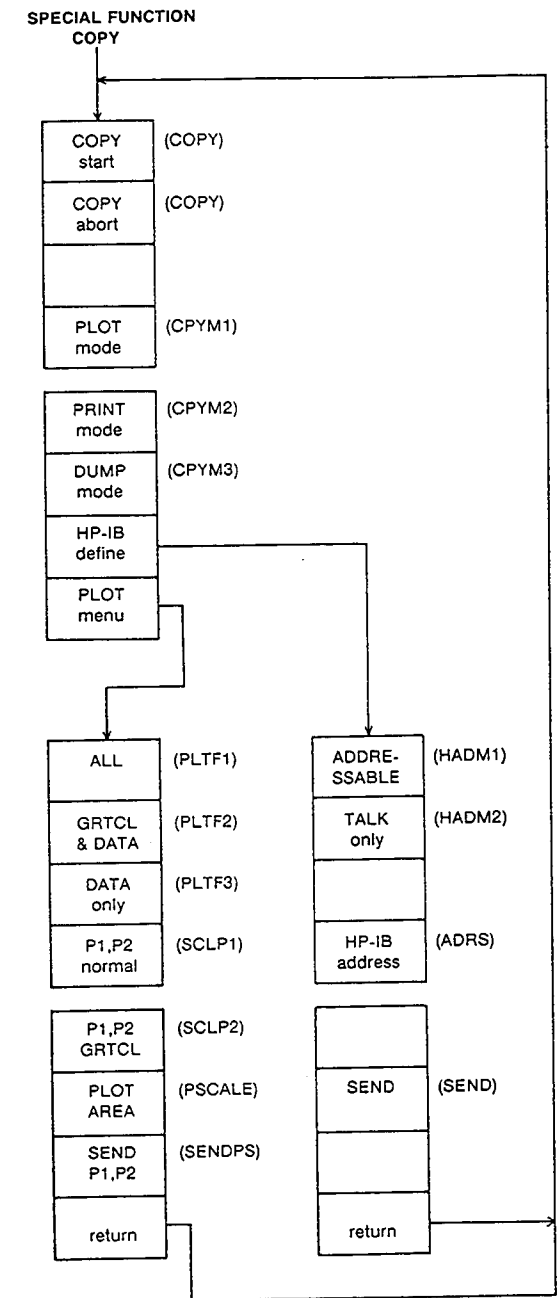

SPECIAL FUNCTION COPY Softkey Tree

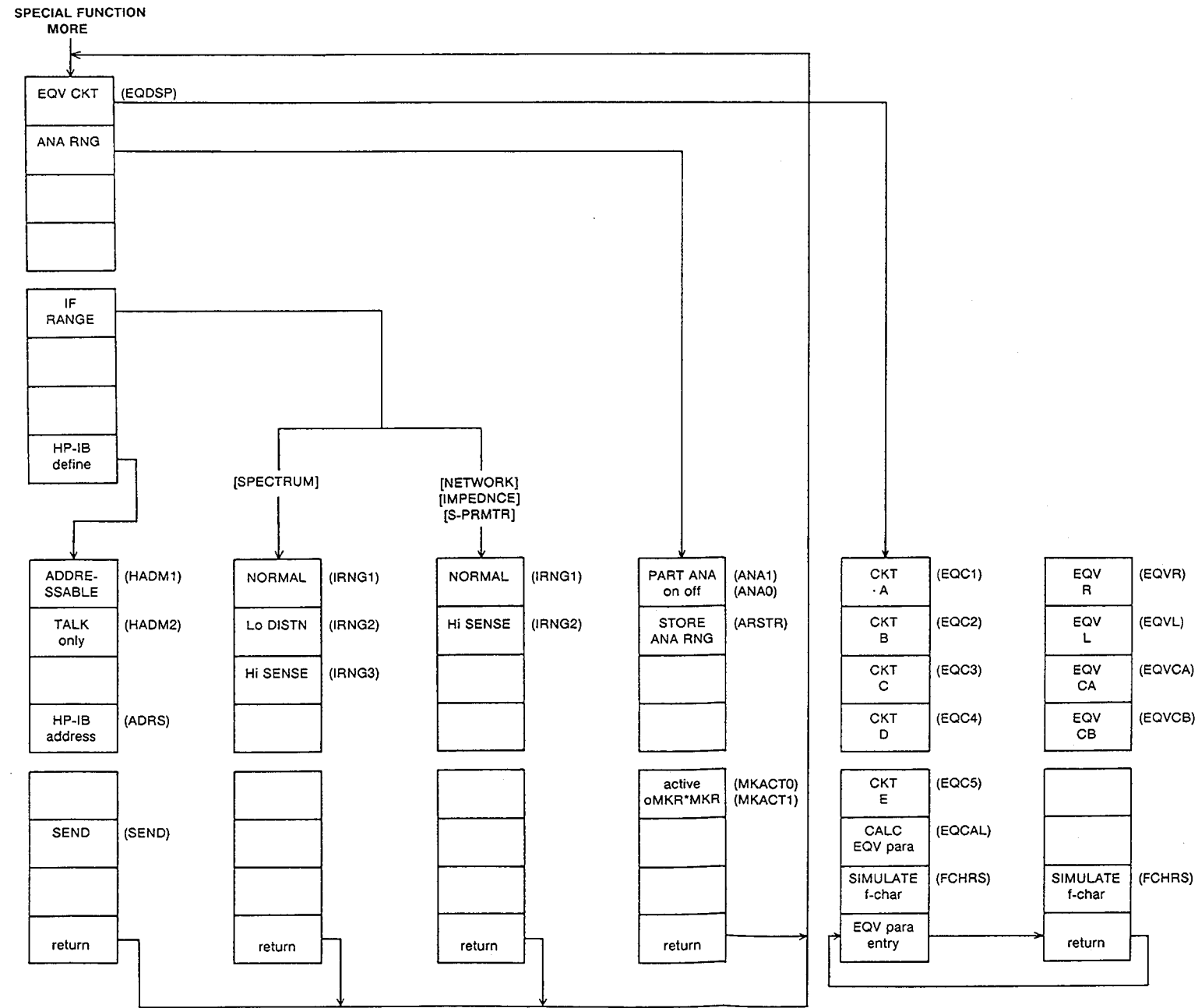

SPECIAL FUNCTION MORE Softkey Tree

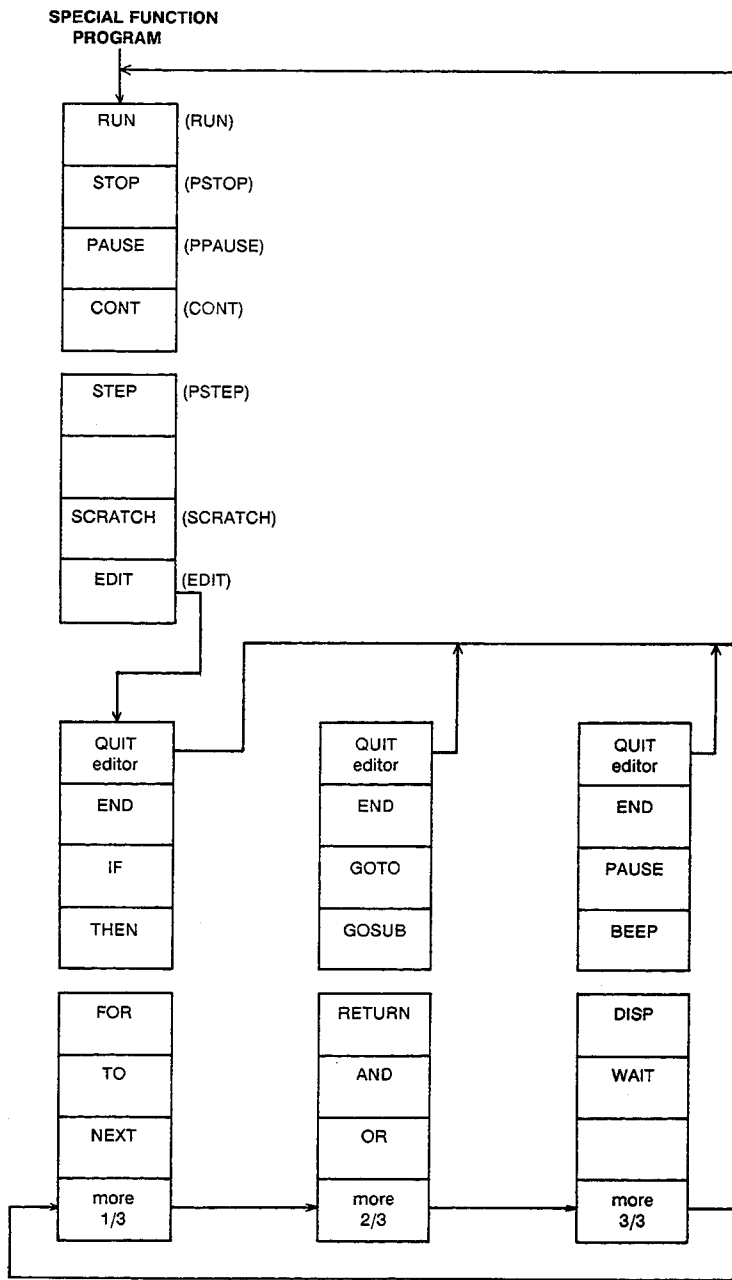

SPECIAL FUNCTION PROGRAM Softkey Tree

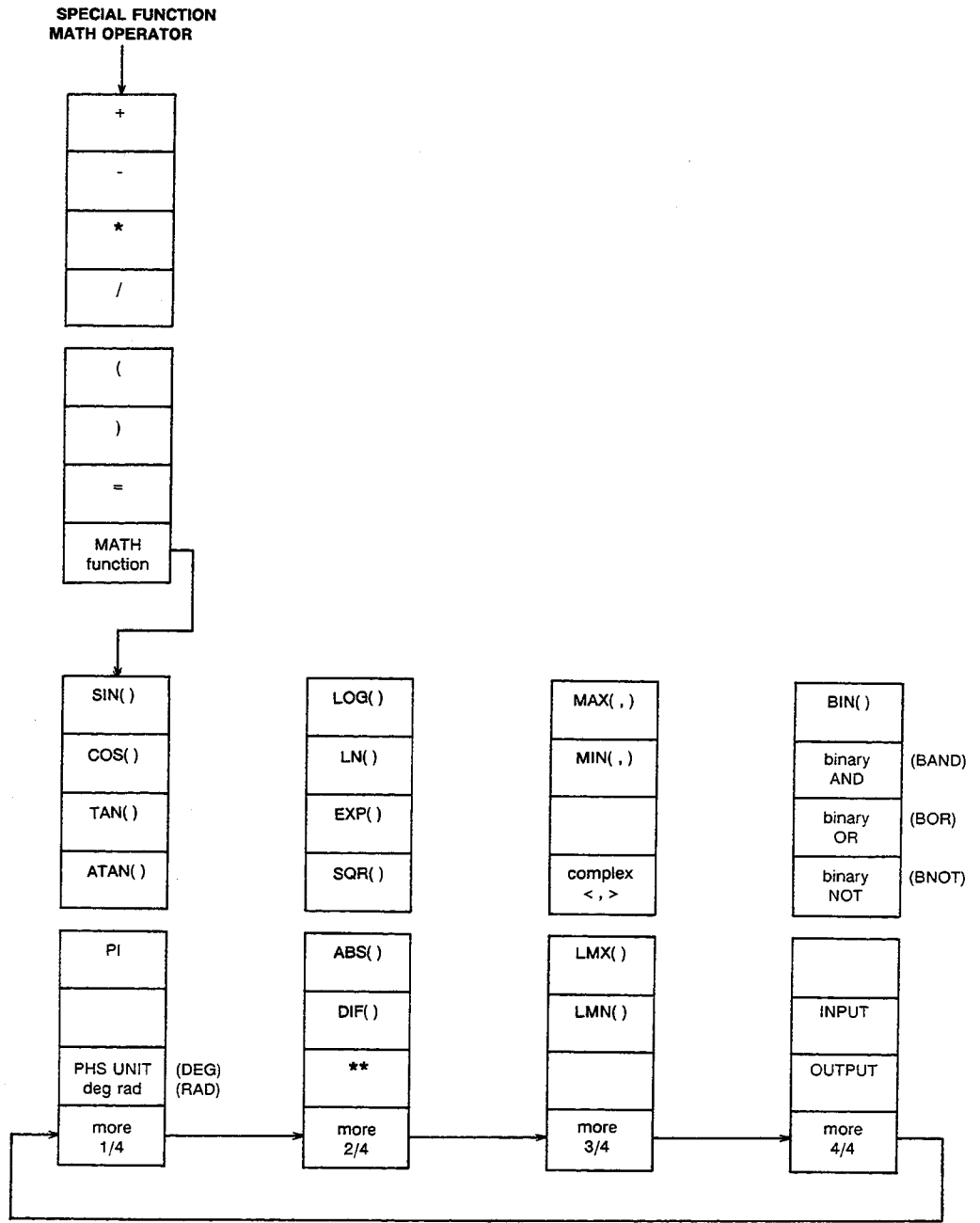

SPECIAL FUNCTION MATH OPERATOR Softkey Tree

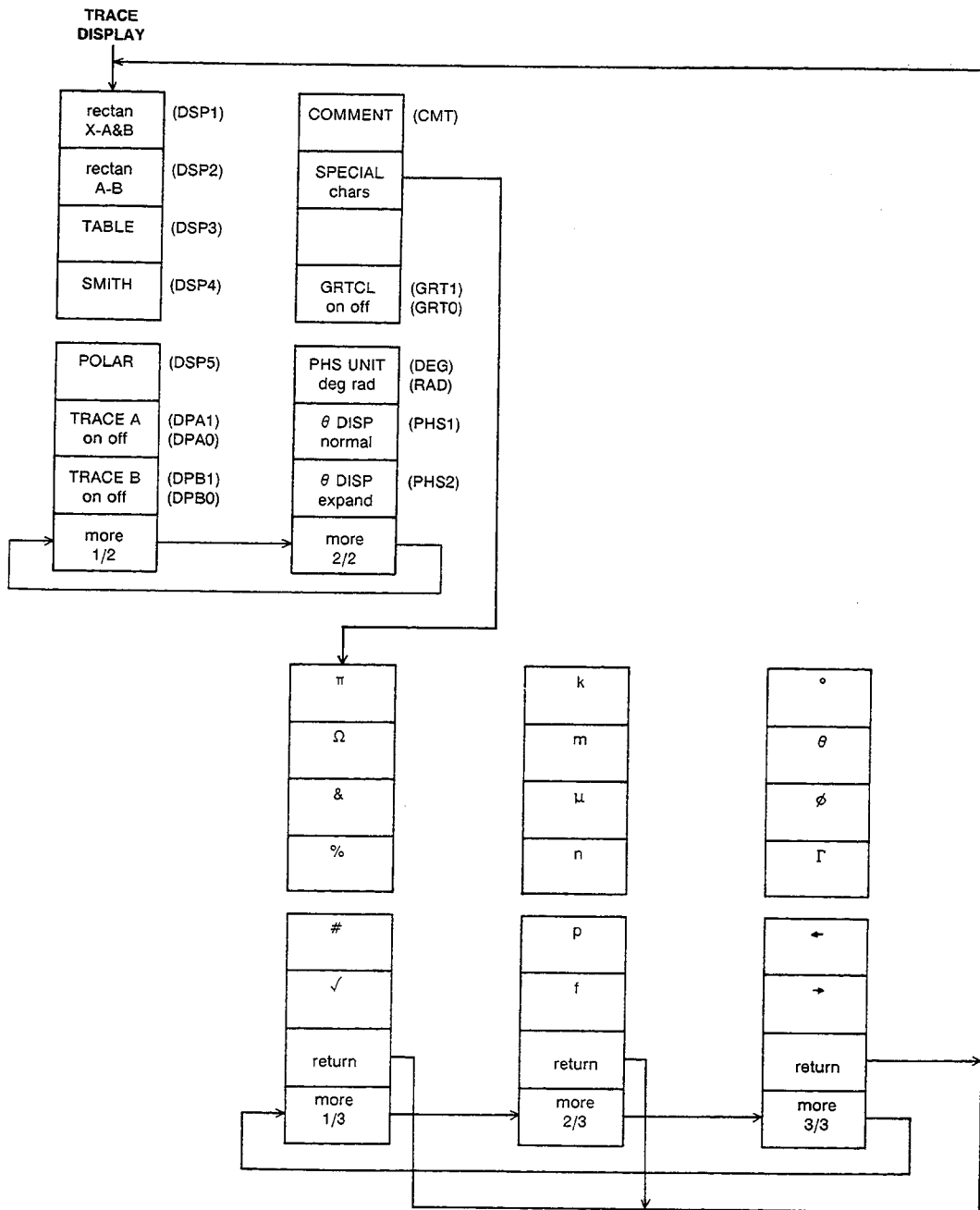

TRACE DISPLAY Softkey Tree

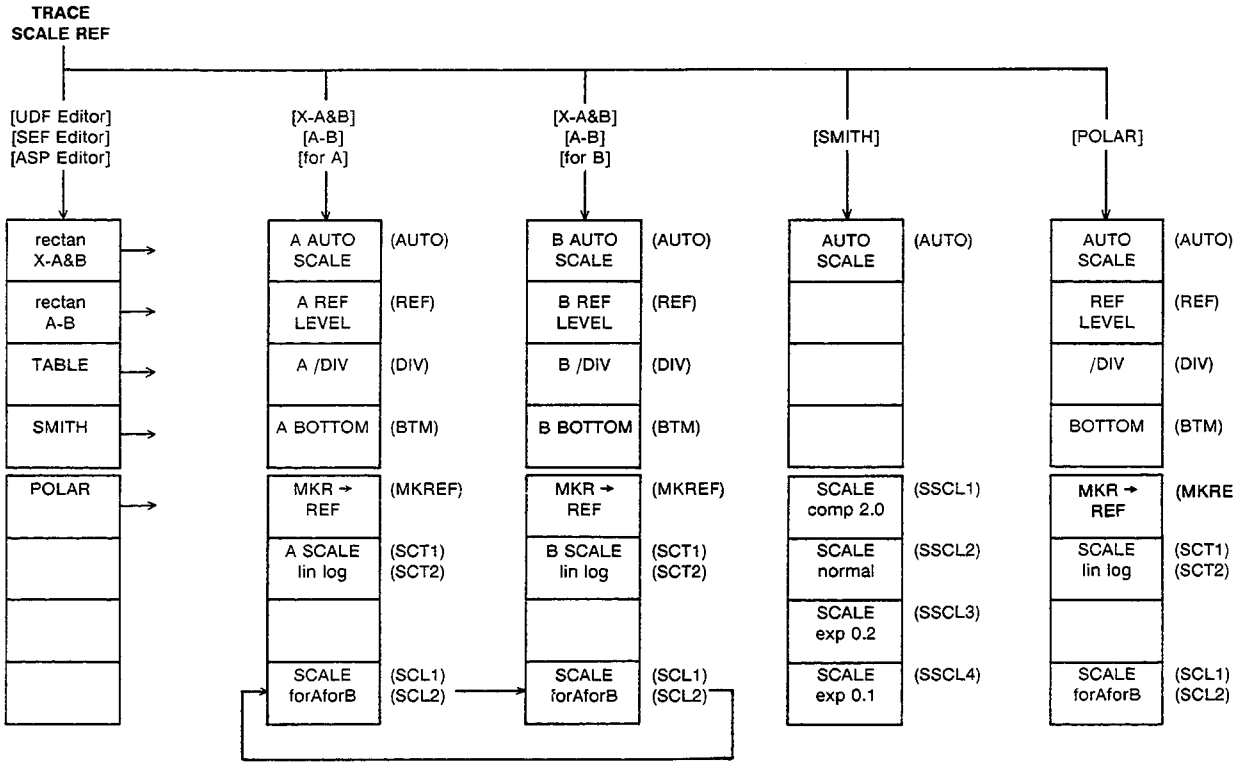

TRACE SCALE REF Softkey Tree

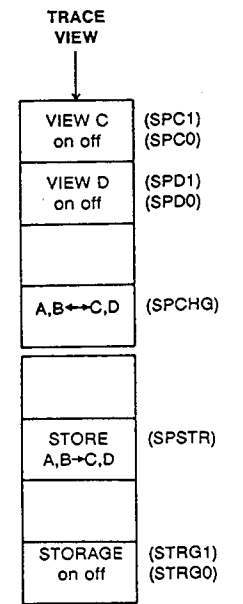

TRACE VIEW Softkey Tree

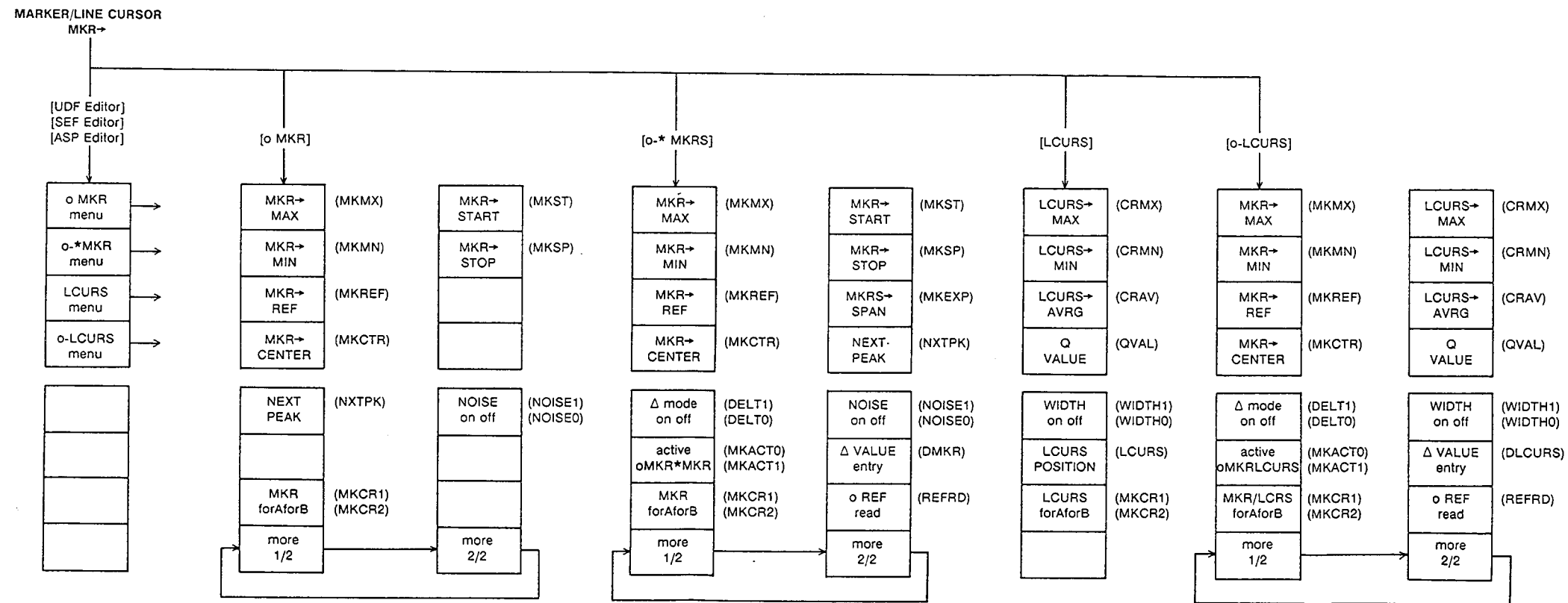

MARKER/LINE CURSOR MKR→ Softkey Tree

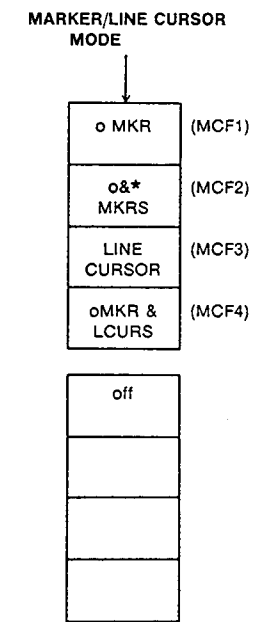

MARKER/LINE CURSOR MODE Softkey Tree

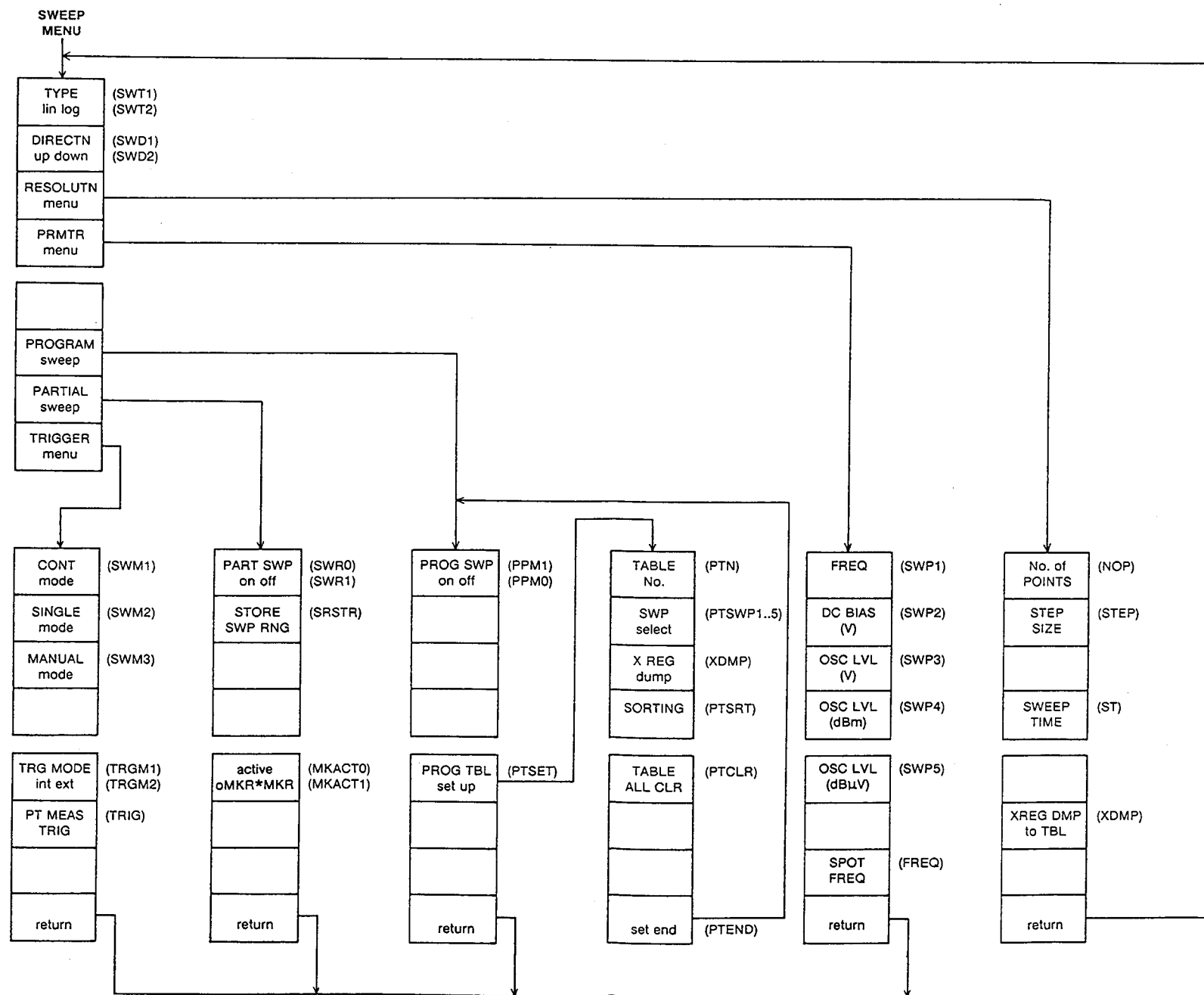

SWEEP MENU Softkey Tree

APPENDIX E

COMMAND LIST

Appendix E lists the 4195A's control commands in alphabetical order. The register-type commands (syntax type #2) are not listed in the following table, but are listed in the Registers List in Appendix F.

Syntax type numbers in the list correspond to the syntax type number in the following Syntax Number Quick Reference and that in Table 6-1.

Syntax Number Quick Reference

Syntax Number	Syntax Name	Description
1	Header only type	Does not have selection option.
2	Register type	Equal sign and single value follows.
3	Cal. Std. type	Equal sign and two values follows.
4	POINT type	Equal sign and two values follows. One value is optional.
5	PSCALE type	Equal sign and four values follows.
6	String data type	Character string follows.
7	DISP type	Character string or register name follows.
8	PROG type	Character string start with line number follows.
9	Select type	One or two digit select number follows.
10	INPUT type	Register name follows.
11	OUTPUT type	Register name or eight digit binary expression follows.
12	EDIT type	Line number (optional) follows.
13	Define Math type	Equal sign and math definition follows.
14	LMX type	Array register name in a pair of parenthesis follows.

NOTE

A black triangle (►) indicates that the select-type command is selected by the default settings. A bullet (•) indicates that the command cannot be multi-statement programmed.

- A -

Command	Syntax	Key	Description
● ABTCAL	1	'ABORT CAL'	Aborts progressing calibration measurement.
● ABTCMP	1	'ABORT COMPEN'	Aborts progressing impedance compensation measurement.
▶ ANA0	9	'PART ANA on off'	Turns off partial analysis.
ANA1	9	'PART ANA on off'	Turns on partial analysis.
ARSTR	1	'STORE ANA RNG'	Specifies the partial analysis range by the current o and * markers positions.
● AUDF	1	'EXIT UDF edit'	Aborts editing the user defined function (UDF) or the sweep end function, and exits from the editor.
AUTO	1	'AUTO SCALE'	Changes the display scale properly to the data.

- B -

No commands beginning with B.

- C -

Command	Syntax	Key	Description
▶ CALT0	9	'CAL NONE'	Selects no-calibration type.
CALT1	9	'NORMLIZE (OPEN)'	When in Network, S11, or S22 configuration, selects normalize (OPEN) calibration type.
		'NORMLIZE (THRU)'	When in S21 or S12 configuration, selects normalize (THROUGH) calibration type.
		'ONE PORT FULL CAL'	When in the impedance configuration, selects one port full calibration type.
CALT2	9	'ONE PORT PART CAL'	When in Network, S11, or S22 configuration, selects one port partial calibration type.
		'NORM&ISN CAL'	When in S21 or S12 configuration, selects normalize & isolation calibration.

CALT3	9	'ONE PORT FULL CAL'	When in Network, S11, or S22 configuration, selects one port full calibration type.
CALT4	9	'NORMLIZE (THRU)'	When in Network configuration, selects normalize (THROUGH) calibration type.
CALT5	9	'NORM&ISN CAL'	When in Network configuration, selects normalize & isolation calibration type.
• CAT	1	'CAT'	Displays micro flexible disc contents file catalog.
► CHRZ1	9	'Z0 50Ω 75Ω'	Selects 50Ω characteristic impedance.
CHRZ2	9	'Z0 50Ω 75Ω'	Selects 75Ω characteristic impedance.
CLS	1	---	Clears the HP-IB status byte.
► CMPT0	9	'COMPEN NONE'	Turns off impedance compensation.
CMPT1	9	'0S OFFSET'	Selects only 0S offset compensation.
CMPT2	9	'0Ω OFFSET'	Selects only 0Ω offset compensation.
CMPT3	9	'0S&0Ω OFFSET'	Selects both 0S and 0Ω offset compensation.
CMT	6	'COMMENT'	Displays a character string in the comment area of the CRT.
CMT?	1	---	Stores the comment contents into the HP-IB output buffer.
• CONT	1	'CONT'	Continues a paused user program (ASP).
• COPY	1	'COPY start' 'COPY abort'	Starts or aborts the hard copy operation.
► CORR0	9	'CORRECTN on off'	Turns off correction.
CORR1	9	'CORRECTN on off'	Turns on correction.
CPL0	9	AUTO off	RBW setting is fixed at a specified bandwidth.
► CPL1	9	AUTO on	RBW setting is automatically selected by other settings.

CPYM1	9	'PLOT mode'	Selects plot hard copy mode.
CPYM2	9	'PRINT mode'	Selects print hard copy mode.
▶ CPYM3	9	'DUMP mode'	Selects raster graphics dump hard copy mode.
CPYM4	9	'color DUMP mode'	Selects color graphics dump hard copy mode.
CRAV	1	'LCURS→ AVRG'	Moves the line cursor to the average value.
CRMN	1	'LCURS→ MIN'	Moves the line cursor to the minimum data value.
CRMX	1	'LCURS→ MAX'	Moves the line cursor to the maximum data value.

- D -

Command	Syntax	Key	Description
DCOFF	1	OFF/ABORT	Turns off the dc source.
▶ DEG	1	'PHS UNIT deg rad'	Selects the degree angle mode.
▶ DELT0	9	'Δmode on off '	Turns off the Δmode.
DELT1	9	'Δmode on off'	Turns on the Δmode.
DF1	6	'fctn 1'	Defines user defined function #1.
DF2	6	'fctn 2'	Defines user defined function #2.
DF3	6	'fctn 3'	Defines user defined function #3.
DF4	6	'fctn 4'	Defines user defined function #4.
DF5	6	'fctn 5'	Defines user defined function #5.
DFA	6	'fctn A'	Defines the sweep end function #A.
DFB	6	'fctn B'	Defines the sweep end function #B.
DFC	6	'fctn C'	Defines the sweep end function #C.
DISP	7	'DISP'	Displays a character string, Rn register data or both on the system message line of the CRT.

DISP?	1	---	Stores the DIS played character string, Rn register data or both into the HP-IB output buffer.
DMA	13	'DEFINE MATH A'	Defines user math A equation.
DMB	13	'DEFINE MATH B'	Defines user math B equation.
DPA0	9	'TRACE A on off'	Turns off trace A.
▶ DPA1	9	'TRACE A on off'	Turns on trace A.
DPB0	9	'TRACE B on off'	Turns off trace B.
▶ DPB1	9	'TRACE B on off'	Turns on trace B.
▶ DSP1	9	'rectan X-A&B'	Selects the rectan X-A&B display format.
DSP2	9	'rectan A-B'	Selects the rectan A-B display format.
DSP3	9	'TABLE'	Selects the table display format.
DSP4	9	'SMITH'	Selects the Smith chart display format.
DSP5	9	'POLAR'	Selects the polar chart display format.

- E -

Command	Syntax	Key	Description
EDIT	12	'EDIT'	Initiates the user program (ASP) editor.
▶ EQC1	9	'CKT A'	Selects equivalent circuit analysis model A.
EQC2	9	'CKT B'	Selects equivalent circuit analysis model B.
EQC3	9	'CKT C'	Selects equivalent circuit analysis model C.
EQC4	9	'CKT D'	Selects equivalent circuit analysis model D.
EQC5	9	'CKT E'	Selects equivalent circuit analysis model E.

• EQCAL	1	'CALC EQV para'	Calculates the equivalent circuit parameters of the equivalent circuit analysis.
• EQDSP	1	'EQV CKT'	Displays equivalent circuit model selection screen.
ERR?	1	---	Stores the error number string data (being stored in the ERR register) to the HP-IB output buffer.

- F -

Command	Syntax	Key	Description
• FCHRS	1	'SIMULATE f-char'	Simulates frequency response of the specified equivalent circuit model and equivalent circuit parameter.
▶ FMT1	9	---	Selects ASCII output format of the HP-IB.
FMT2	9	---	Selects HP-IB IEEE-64 bit floating point output format.
FMT3	9	---	Selects HP-IB IEEE-32 bit floating point output format.
▶ FNC1	9	'NETWORK'	Selects the Network configuration.
FNC2	9	'SPECTRUM'	Selects the Spectrum configuration.
FNC3	9	'IMPEDANCE'	Selects the Impedance configuration.
FNC4	9	'S11'	Selects the S11 configuration.
FNC5	9	'S21'	Selects the S21 configuration.
FNC6	9	'S12'	Selects the S12 configuration.
FNC7	9	'S22'	Selects the S22 configuration.
FORMAT	1	'format DISC'	Formats a flexible disc (initialization).

- G -

Command	Syntax	Key	Description
• GET	6	'GET'	Gets data from a flexible disc.
▶ GPP1	9	'T/R- θ (dB) 'R2/R1- θ (dB)	Selects the amplitude-ratio (in dB). & phase-difference measurement format.
GPP2	9	'T/R- θ ' 'R2/R1- θ '	Selects the amplitude-ratio & phase- difference measurement format.
GPP3	9	'T/R Re-Im' 'R2/R1 Re-Im'	Selects the amplitude-ratio (real- imaginary) measurement format.
GPP4	9	'T/R- τ (dB) 'R2/R1- τ (dB)	Selects the group-delay measure- ment format.
GRT0	9	'GRTCL on off'	Turns off the display graticule.
▶ GRT1	9	'GRTCL on off'	Turns on the display graticule.

- H -

Command	Syntax	Key	Description
▶ HADM1	9	'ADDRE-SSABLE'	Sets the 4195A HP-IB definition to the addressable mode.
HADM2	9	'TALK only'	Sets the 4195A HP-IB definition to the talk only mode.

- I -

Command	Syntax	Key	Description
ID?	1	---	Stores the device identification string data to the HP-IB output buffer.
▶ IMP1	9	' Z - θ '	Selects the Z - θ impedance mea- surement format.
IMP2	9	'R-X'	Selects the R-X impedance mea- surement format.

IMP3	9	'Ls-Rs'	Selects the Ls-Rs impedance measurement format.
IMP4	9	'Ls-Q'	Selects the Ls-Q impedance measurement format.
IMP5	9	'Cs-Rs'	Selects the Cs-Rs impedance measurement format.
IMP6	9	'Cs-D'	Selects the Cs-D impedance measurement format.
IMP7	9	' Y - θ '	Selects the $ Y - \theta$ impedance measurement format.
IMP8	9	'G-B'	Selects the G-B impedance measurement format.
IMP9	9	'Lp-Rp'	Selects the Lp-Rp impedance measurement format.
IMP10	9	'Lp-Q'	Selects the Lp-Q impedance measurement format.
IMP11	9	'Cp-Rp'	Selects the Cp-Rp impedance measurement format.
IMP12	9	'Cp-D'	Selects the Cp-D impedance measurement format.
INPUT	10	'INPUT'	Stores the 8-bit input data into a Rn register.
► IRNG1	9	'NORMAL'	Selects the normal IF range.
IRNG2	9	'Lo DISTN'	Selects the low-distortion IF range when in Spectrum configuration.
		'Hi SENS'	Selects the high-sensitivity IF range when in Network/S-parameter/Impedance configuration.
IRNG3	9	'Hi SENS'	Selects the high-sensitivity IF range when in Spectrum configuration.
● ISNCAL	1	'ISOLATN'	Initiates the isolation calibration measurement.

- J -

No commands beginning with J

- K -

No commands beginning with K

- L -

Command	Syntax	Key	Description
LBL1	6	'fctn1 KEY LBL'	Defines the user-defined-function #1 softkey label.
LBL2	6	'fctn2 KEY LBL'	Defines the user-defined-function #2 softkey label.
LBL3	6	'fctn3 KEY LBL'	Defines the user-defined-function #3 softkey label.
LBL4	6	'fctn4 KEY LBL'	Defines the user-defined-function #4 softkey label.
LBL5	6	'fctn5 KEY LBL'	Defines the user-defined-function #5 softkey label.
LBLA	6	'fctnA KEY LBL'	Defines the sweep-end-function #A softkey label.
LBLB	6	'fctnB KEY LBL'	Defines the sweep-end-function #B softkey label.
LBLC	6	'fctnC KEY LBL'	Defines the sweep-end-function #C softkey label.
• LDCAL	1	'LOAD'	Initiates the load calibration measurement.
• LDNSTD=	3	'LOAD CAL STD'	Enters the Load calibration standard's calibrated values.
LMN	14	'LMN'	Moves the o and * markers to the local-minimum points.
LMX	14	'LMX'	Moves the o and * markers to the local-maximum points.

- M -

Command	Syntax	Key	Description
• MAX	---	'MAX(,)'	Returns the maximum value.
MCF0	9	'off'	Turns the MARKER function off.
► MCF1	9	'o MKR'	Selects the o MARKER mode.
MCF2	9	'o&* MKRS'	Selects the o and * MARKERS mode.
MCF3	9	'LINE CURSOR'	Selects the LINE CURSOR mode.
MCF4	9	'oMKR & LCURS'	Selects the o-LCURS mode.

• MIN	---	'MIN(,)'	Returns the minimum value.
▶ MKACT0	9	'active oMKR*MKR'	Selects the active marker to * MARKER.
MKACT1	9	'active oMKR*MKR'	Selects the active marker to o MARKER.
▶ MKACT2	9	'active LCRS'	Selects the LCURS to active.
▶ MKCR1	9	'LCURS forAforB'	Selects the LCURS reading object to data A.
MKCR2	9	'LCURS forAforB'	Selects the LCURS reading object to data B.
MKCTR	1	'MKR→ CENTER'	Changes the CENTER value with the MARKER point value.
MKEXP	1	'MKRS→ SPAN'	Expands the sweep span specified by MARKERS to full screen width.
MKMN	1	'MKR→ MIN'	Move the marker to the minimum data point.
MKMX	1	'MKR→ MAX'	Move the marker to the maximum data point.
MKREF	1	'MKR→ REF'	Changes the display scale (top value) with the marker reading value.
MKSP	1	'MKR→ STOP'	Changes the STOP value with the MARKER point value.
MKST	1	'MKR→ START'	Changes the START value with the MARKER point value.
▶ MTHA0	9	'MATH→A on off'	Turns off User Math A function.
MTHA1	9	'MATH→A on off'	Turns on User Math A function.
▶ MTHB0	9	'MATH→B on off'	Turns off User Math B function.
MTHB1	9	'MATH→B on off'	Turns on User Math B function.

- N -

Command	Syntax	Key	Description
▶ NOISE0	9	'NOISE on off'	Turns off the Noise Marker reading.
NOISE1	9	'NOISE on off'	Turns on the Noise Marker reading.
NXTPK	1	'NEXT PEAK'	Moves the marker to the next lower peak.

- O -

Command	Syntax	Key	Description
● OPNCAL	1	'OPEN'	Initiates the Open calibration measurement.
● OPNSTD=	3	'OPEN CAL STD'	Enters the Open calibration standard's calibrated values.
OUTPUT	11	'OUTPUT'	Outputs 8-bit data to the 8-BIT INPUT/OUTPUT connector.

- P -

Command	Syntax	Key	Description
▶ PEXT0	9	'PORT EXT on off'	Turns off the port extension.
PEXT1	9	'PORT EXT on off'	Turns on the port extension.
PHS1	9	' θ DISP normal'	Measures the phase angle within the range of $\pm 180^\circ$ (wrap-around).
PHS2	9	' θ DISP expand'	Measures the phase angle continuously (no wrap-around).
▶ PLTF1	9	'ALL'	Specifies the plotted item to all.
PLTF2	9	'GRCTL & DATA'	Specifies the plotted item only to graticule and traces.
PLTF3	9	'DATA only'	Specifies the plotted item only traces.
● POINT=	4	---	Enters program point table data without using the editor.

▶ PORT1	9	'T1/R1'	When in other than spectrum configuration selects T1 measurement referenced to R1. S1 is also selected. For S11 configuration, this is the default setting.
		'R1'	When in spectrum configuration selects R1 input.
PORT2	9	'T2/R1'	When in other than spectrum configuration selects T2 measurement referenced to R1. S1 is also selected. For S21 configuration, this is the default setting.
		'T1'	When in spectrum configuration selects T1 input.
PORT3	9	'R2/R1'	When in other than spectrum configuration selects R2 measurement referenced to R1. S1 is also selected.
		'R2'	When in spectrum configuration selects R2 input.
PORT4	9	'T1/R2'	When in other than spectrum configuration selects T1 measurement referenced to R2. S2 is also selected. For S12 configuration, this is the default setting.
		'T2'	When in spectrum configuration selects T2 input.
PORT5	9	'T2/R2'	When in other than spectrum configuration selects T2 measurement referenced to R2. S2 is also selected. For S22 configuration, this is the default setting.
● PPAUSE	1	'PAUSE'	Pauses the running User Program (ASP).
▶ PPM0	9	'PROG SWP on off'	Turns off the Program Point Measurement.
PPM1	9	'PROG SWP on off'	Turns on the Program Point Measurement.
PRMA	6	'A PRMTR LBL'	Registers the User Math A label.
PRMB	6	'B PRMTR LBL'	Registers the User Math B label.

PROG	8	---	Enters User Program statement lines without using the editor.
PSCALE=	5	'PLOT AREA'	Enters plot size data.
● PSTEP	1	'STEP'	Single steps the next line of the User Program (ASP).
● PSTOP	1	'STOP'	Stops a running User Program (ASP).
PTCLR	1	'TABLE ALL CLEAR'	Clears data from a program points table.
PTEND	1	'set end'	Exits from the program points table editor.
PTSET	1	'PROG TBL set up'	Enters the program points table editor.
PTSRT	1	'SORTING'	Sorts the measurement points data in the program points table.
▶ PTSWP1	9	'SWP select'	Selects frequency as the sweep parameter for a program points measurement.
PTSWP2	9	'SWP select'	Selects dc bias as the sweep parameter for a program points measurement.
PTSWP3	9	'SWP select'	Selects OSC LEVEL (V) sweep parameter for a program points measurement.
PTSWP4	9	'SWP select'	Selects OSC LEVEL (dBm) sweep parameter for a program points measurement.
PTSWP5	9	'SWP select'	Selects OSC LEVEL (dB μ V) sweep parameter for a program points measurement.
● PURGE	6	'PURGE'	Purges a file from the flexible disc.
▶ PWR0	9	'SOURCE off'	Turns off the tracking generator.
PWR1	9	'SOURCE CH1'	Selects S1 output as the tracking generator output.
PWR2	9	'SOURCE CH2'	Selects S2 output as the tracking generator output.

- Q -

Command	Syntax	Key	Description
QUIT	1	'QUIT editor'	Exits from the user program editor.
QVAL	1	'Q VALUE'	Calculates the Quality factor value at the line cursor.

- R -

Command	Syntax	Key	Description
RAD	1	'PHS UNIT deg rad'	Selects the radian angle mode.
• RCAT	1	'RECOV. files'	Displays recoverable file catalog of the flexible disc.
• RECOVER	6	'RECOVER'	Recovers purged file from the flexible disc.
REFRD	1	'o REF read'	Reads reference marker's value.
• RESAVED	6	'DATA'	Resaves register data.
• RESAVEP	6	'PROGRAM'	Resaves User Program (ASP).
• RESAVES	6	'STATE'	Resaves the instrument settings.
• RESAVET	6	'PROG TABLE'	Resaves the program points table.
REV?	1	---	Stores the firmware revision code string data into the HP-IB output buffer.
RST	1	PRESET	Sets the 4195A controls to default settings.
• RUN	1	'RUN'	Runs the User Program (ASP).

- S -

Command	Syntax	Key	Description
▶ SAP1	9	'dBm'	Selects dBm as the Spectrum measurement unit.
SAP2	9	'dB μ V'	Selects dB μ V as the Spectrum measurement unit.

SAP3	9	'V'	Selects V as the Spectrum measurement unit.
SAP4	9	'dBm/Hz'	Selects dBm/Hz as the Spectrum measurement unit.
SAP5	9	'dB μ V/Hz'	Selects dB μ V/ \sqrt Hz as the Spectrum measurement unit.
SAP6	9	' μ V/ \sqrt Hz'	Selects μ V/ \sqrt Hz as the Spectrum measurement unit.
• SAVED	6	'DATA'	Saves register data to the flexible disc.
• SAVEP	6	'PROGRAM'	Saves User Program to the flexible disc.
• SAVES	6	'STATE'	Saves Instrument settings to the flexible disc.
• SAVET	6	'PROG TABLE'	Saves the program points table to the flexible disc.
▶ SCL1	9	'SCALE forA forB'	Selects the active scale change data to data A.
SCL2	9	'SCALE forA forB'	Selects the active scale change data to data B.
▶ SCLP1	9	'P1,P2 normal'	Specifies the plotting area by all display area.
SCLP2	9	'P1,P2 GRCTL'	Specifies the plotting area by the graticule area.
SCRATCH	1	'SCRATCH'	Erases the User Program from the work area.
▶ SCT1	9	'SCALE lin log'	Selects the linear display scale.
SCT2	9	'SCALE lin log'	Selects the logarithmic scale display.
▶ SEFA0	9	'A'	Turns off Sweep End Function A.
SEFA1	9	'A'	Turns on Sweep End Function A.
▶ SEFB0	9	'B'	Turns off Sweep End Function B.
SEFB1	9	'B'	Turns on Sweep End Function B.

▶ SEFC0	9	'C'	Turns off Sweep End Function C.
SEFC1	9	'C'	Turns on Sweep End Function C.
SEND	6	'SEND'	Stores specified character string to HP-IB output buffer.
SENDPS	1	'SEND P1,P2'	Sends plotting area command to the plotter.
● SHTCAL	1	'SHORT'	Initiates the short calibration measurement.
● SHTSTD=	3	'SHORT CAL STD'	Enters the short calibration standard's calibrated values.
▶ SPC0	9	'VIEW C on off'	Turns off superimpose C data display.
SPC1	9	'VIEW C on off'	Turns on superimpose C data display.
SPCHG	1	'A,B→C,D'	Swaps data in A and B with data in C and D array registers, respectively.
▶ SPD0	9	'VIEW D on off'	Turns off superimpose D data display.
SPD1	9	'VIEW D on off'	Turns on superimpose D data display.
▶ SPI1	9	'RL-θ'	When in S11 or S22 configuration, selects return-loss measurement.
SPI2	9	'Γ-θ'	When in S11 or S22 configuration, selects reflection coefficient (amplitude and phase) measurement.
SPI3	9	'Γx-Γy'	When in S11 or S22 configuration, selects reflection coefficient (real and imaginary) measurement.
SPI4	9	'SWR-θ'	When in S11 or S22 configuration, selects SWR measurement.
SPSTR	1	'STORE A,B→C,D'	Stores data in A and B registers into C and D array registers, respectively.
SRSTR	1	'STORE SWP RNG'	Specifies the partial sweep range.

SSCL1	9	'SCALE comp 2.0'	Compresses the Smith chart scale to 2.0.
▶ SSCL2	9	'SCALE normal'	Selects the normal Smith chart scale.
SSCL3	9	'SCALE exp 0.2'	Expands the Smith chart scale to 0.2.
SSCL4	9	'SCALE exp 0.1'	Expands the Smith chart scale to 0.1.
STB?	1	---	Stores the status-byte's string data into the HP-IB output buffer.
STDDSP	1	'CAL STD modify'	Displays registered calibration standards calibrated data.
▶ STRG0	9	'STORAGE on off'	Turns the storage display off.
STRG1	9	'STORAGE on off'	Turns on the storage display.
▶ SWD1	9	'DIRECTION up down'	Selects upward sweep.
SWD2	9	'DIRECTION up down'	Selects downward sweep.
▶ SWM1	9	'CONT mode'	Selects continuous sweep.
SWM2	9	'SINGLE mode'	Selects single sweep.
SWM3	9	'MANUAL mode'	Selects manual point sweep.
▶ SWP1	9	'FREQ'	Selects frequency sweep.
SWP2	9	'DC BIAS (V)'	Selects dc bias sweep.
SWP3	9	'OSC LVL (V)'	Selects OSC LEVEL (V) sweep.
SWP4	9	'OSC LVL (dBm)'	Selects OSC LEVEL (dBm) sweep.
SWP5	9	'OSC LVL (dB μ V)'	Selects OSC LEVEL (dB μ V) sweep.
▶ SWR0	9	'PART SWP on off'	Turns off partial sweep measurement.
SWR1	9	'PART SWP on off'	Turns on partial sweep measurement.
▶ SWT1	9	'TYPE lin log'	Sweeps linearly.
SWT2	9	'TYPE lin log'	Sweeps logarithmic step.
● SWTRG	1	TRIGGER RESET	Resets the sweep measurement and restarts the sweep.

- T -

Command	Syntax	Key	Description
● THRCAL	1	'THRU'	Initiates the Through calibration measurement.
▶ TRGM1	9	'TRG MODE int ext'	Selects internal trigger mode.
TRGM2	9	'TRG MODE int ext'	Selects external trigger mode.
● TRIG	1	'PT MEAS TRIG'	Triggers each one point measurement.

- U -

Command	Syntax	Key	Description
UDF1	1	'1'	Executes User Defined Function #1.
UDF2	1	'2'	Executes User Defined Function #2.
UDF3	1	'3'	Executes User Defined Function #3.
UDF4	1	'4'	Executes User Defined Function #4.
UDF5	1	'5'	Executes User Defined Function #5.
UNITA	6	'A UNIT LBL'	Enters User Math A unit label.
UNITB	6	'B UNIT LBL'	Enters User Math B unit label.

- V -

Command	Syntax	Key	Description
▶ VFTR0	9	VIDEO FILTER off	Turns video filter off.
VFTR1	9	VIDEO FILTER on	Turns video filter on.

- W -

Command	Syntax	Key	Description
▶ WIDTH0	9	'WIDTH on off'	Turns off width read-out.
WIDTH1	9	'WIDTH on off'	Turns on width read-out.

- X -

Command	Syntax	Key	Description
XDMP	1	'XREG DMP to TBL'	Copies the X register data into the program point table.

- Y -

No commands beginning with Y.

- Z -

Command	Syntax	Key	Description
• ZOCMP	1	'0Ω'	Initiates the 0Ω compensation data acquisition measurement.
• ZSCMP	1	'0S'	Initiates the 0S compensation data acquisition measurement.

- other -

Command	Syntax	Key	Description
• REG_NAM?	1	---	Stores the register data into the HP-IB output buffer. REG_NAM is any register name.

NOTES

APPENDIX F

REGISTER LIST

The HP 4195A's internal registers are listed in this appendix. Data can be read from all of the registers listed here. A black triangle (▶) indicates that the registers are read-only registers.

NOTE

The Multiple Registers are not listed in this appendix but are listed in appendix E. Data cannot be read from the Multiple Registers, so they are treated as commands rather than as registers.

ARRAY REGISTERS

1) DISPLAY/MEASUREMENT REGISTERS

Register	Description
A	The A register is a measurement data register and is displayed on the CRT as a bright yellow trace. When the 4195A is making a measurement, the data in register A is updated automatically.
B	The B register is a measurement data register and is displayed on the CRT as a bright cyan trace. When the 4195A is making a measurement, the data in register B is updated automatically.
C	The C register is a superimpose data register and when selected is displayed on the CRT as an unintensified yellow trace.
D	The D register is a superimpose data register and when selected is displayed on the CRT as an unintensified cyan trace.
▶ MA	The MA register is a measurement data register for data A. This register is used by the User Math function. This is a read-only register.
▶ MB	The MB register is a measurement data register for data B. This register is used by the User Math function. This is a read-only register.
▶ X	The X register stores the sweep point data. Because the data in this register is calculated data, the X register is a read-only register.

2) GENERAL PURPOSE REGISTERS

Registers E, F, G, H, I, J, RA, RB, RC, RD, RE and RF are general purpose registers.

3) CALIBRATION DATA REGISTERS**3-1) S11 and Network-Reflection Calibration**

Register	Description
MFOR	The MFOR register is used to store the real components of the OPEN termination calibration measurement results.
MFOI	The MFOI register is used to store the imaginary components of the OPEN termination calibration measurement results.
MFSR	The MFSR register is used to store the real components of the SHORT termination calibration measurement results.
MFSI	The MFSI register is used to store the imaginary components of the SHORT termination calibration measurement results.
MFLR	The MFLR register is used to store the real components of the LOAD termination calibration measurement results.
MFLI	The MFLI register is used to store the imaginary components of the LOAD termination calibration measurement results.
TFOR	The TFOR register is used to store the real components of the OPEN termination theoretical calibration data.
TFOI	The TFOI register is used to store the imaginary components of the OPEN termination theoretical calibration data.
TFSR	The TFSR register is used to store the real components of the SHORT termination theoretical calibration data.
TFSI	The TFSI register is used to store the imaginary components of the SHORT termination theoretical calibration data.
TFLR	The TFLR register is used to store the real components of the LOAD termination theoretical calibration data.
TFLI	The TFLI register is used to store the imaginary components of the LOAD termination theoretical calibration data.

3-2) S21 and Network-Transmission Calibration

Register	Description
MFTR	The MFTR register is used to store the real components of the normalized (through) calibration measurement results.
MFTI	The MFTI register is used to store the imaginary components of the normalized (through) calibration measurement results.
MFIR	The MFIR register is used to store the real components of the isolation calibration measurement results.
MFII	The MFII register is used to store the imaginary components of the isolation calibration measurement results.

3-3) S12 Calibration

Register	Description
MRTR	The MRTR register is used to store the real components of the normalized (through) calibration measurement results.
MRTI	The MRTI register is used to store the imaginary components of the normalized (through) calibration measurement results.
MRIR	The MRIR register is used to store the real components of the isolation calibration measurement results.
MRII	The MRII register is used to store the imaginary components of the isolation calibration measurement results.

3-4) S22 and Impedance Calibration

Register	Description
MROR	The MROR register is used to store the real components of the OPEN termination calibration measurement results.
MROI	The MROI register is used to store the imaginary components of the OPEN termination calibration measurement results.
MRSR	The MRSR register is used to store the real components of the SHORT termination calibration measurement results.
MRSI	The MRSI register is used to store the imaginary components of the SHORT termination calibration measurement results.
MRLR	The MRLR register is used to store the real components of the LOAD termination calibration measurement results.
MRLI	The MRLI register is used to store the imaginary components of the LOAD calibration measurement results.

TROR	The TROR register is used to store the real components of the OPEN termination theoretical calibration data.
TROI	The TROI register is used to store the imaginary components of the OPEN termination theoretical calibration data.
TRSR	The TRSR register is used to store the real components of the SHORT termination theoretical calibration data.
TRSI	The TRSI register is used to store the imaginary components of the SHORT termination theoretical calibration data.
TRLR	The TRLR register is used to store the real components of the LOAD termination theoretical calibration data.
TRLI	The TRLI register is used to store the imaginary components of the LOAD termination theoretical calibration data.

3-5) Impedance Compensation

Register	Description
ZOR	The ZOR register is used to store the impedance measurement 0Ω offset compensation data.
ZOX	The ZOX register is used to store the impedance measurement 0Ω offset compensation data.
ZSG	The ZSG register is used to store the impedance measurement $0S$ offset compensation data.
ZSB	The ZSB register is used to store the impedance measurement $0S$ offset compensation data.

SINGLE REGISTERS

Register	Description
ADRS	The ADRS register is used to store the 4195A's HP-IB address. This register is battery backed-up. The range of values which can be stored in this register is an integer from 0 to 30.
ATR1	The ATR1 register is used to store the attenuation value for the Channel 1 reference input. The range of values which can be stored in this register is an integer from 0 to 50 in steps of 10.
ATR2	The ATR2 register is used to store the attenuation value for the Channel 2 reference input. The range of values which can be stored in this register is an integer from 0 to 50 in steps of 10.
ATT1	The ATT1 register is used to store the attenuation value for the Channel 1 test input. The range of values which can be stored in this register is an integer from 0 to 50 in steps of 10.

- ATT2** The **ATT2** register is used to store the attenuation value for the Channel 2 test input. The range of values which can be stored in this register is an integer from 0 to 50 in steps of 10.
- BIAS** The **BIAS** register is used to store the value for the dc source output voltage. The range of values which can be stored in this register is from -40 to +40 in steps of 0.01.
- BTM** The **BTM** register is used to store the bottom of display scale. The range of values which can be stored in this register is from $-9.999\text{E}+37$ to $+9.998\text{E}+37$.
- CENTER** The **CENTER** register is used to store the sweep parameter's **CENTER** value. The value range depends on the type of sweep parameter. For example, when in the frequency sweep mode, the range of values for this register is from +0.001 to $+500\text{E}+06$.
- DFREQ** The **DFREQ** register is used to store the group-delay measurement aperture frequency. The aperture frequency is stored as a percent of frequency span. The range of values which can be stored in this register is from 0.5 to 100.0 in steps of 0.5.
- DIV** The **DIV** register is used to store the display scale division value. The range of values which can be stored in this register is from $+5.000\text{E}-36$ to $+9.999\text{E}+37$.
- DLCURS** The **DLCURS** register is used to store the difference value between the o marker (for A or B) and the Line Cursor position (height). The range of values which can be stored in this register is 0 and values between $\pm 1\text{E}-37$ to $\pm 9.99999\text{E}+37$.
- DMKR** The **DMKR** register is used to store the difference value (in the **X** register domain) between the o Marker and the * Marker. The range of values which can be stored in this register is from 0 to the SPAN value.
- **DMKRA** The **DMKRA** register is used to store the difference value (in the **A** register domain) between the o Marker and the * Marker. This is a **read-only** register.
- **DMKRB** The **DMKRB** register is used to store the difference value (in the **B** register domain) between the o Marker and the * Marker. This is a **read-only** register.
- EQVCA** The **EQVCA** register is used to store the Equivalent Circuit Analysis **Ca** capacitance value. The range of values which can be stored in this register is 0 and the values from $\pm 1\text{E}-37$ to $\pm 9.99999\text{E}+37$.
- EQVCB** The **EQVCB** register is used to store the Equivalent Circuit Analysis **Cb** capacitance value. The range of values which can be stored in this register is 0 and the values from $\pm 1\text{E}-37$ to $\pm 9.99999\text{E}+37$.
- EQVL** The **EQVL** register is used to store the Equivalent Circuit Analysis **L** inductance value. The range of values which can be stored in this register is 0 and the values from $\pm 1\text{E}-37$ to $\pm 9.99999\text{E}+37$.

- EQVR** The **EQVR** register is used to store the Equivalent Circuit Analysis **R** resistance value. The range of values which can be stored in this register is 0 and values from $\pm 1\text{E-}37$ to $\pm 9.99999\text{E}+37$.
- ▶ **ERR** The **ERR** register is used to store the error number. This is a **read-only** register.
- FREQ** The **FREQ** register is used to store the measurement frequency value for the DC Bias or OSC Level sweeps. The range of values which can be stored in this register is from +0.001 to +500E+06.
- LCURS** The **LCURS** register is used to store the line cursor position (height) value. The range of values which can be stored in this register is 0 and values from $\pm 1\text{E-}37$ to $\pm 9.99999\text{E}+37$.
- ▶ **LCURSL** The **LCURSL** register is used to store the value of the left most intersect point (in the **X** register domain). This is a **read-only** register.
- ▶ **LCURSR** The **LCURSR** register is used to store the value of the right most intersect point (in the **X** register domain). This is a **read-only** register.
- MANUAL** The **MANUAL** register is used to store the manual sweep point value. The range of values which can be stored in this register is from the **START** value to the **STOP** value.
- MKR** The **MKR** register is used to store the value of the o marker position (in the **X** register domain). The range of values which can be stored in this register is from the **START** value to the **STOP** value.
- ▶ **MKRA** The **MKRA** register is used to store the data A value specified with the o marker. This is a **read-only** register.
- ▶ **MKRB** The **MKRB** register is used to store the data B value specified with the o marker. This is a **read-only** register.
- NOP** The **NOP** register is used to store the number of sweep points. The range of values which can be stored in this register is an integer from 2 to 401.
- ▶ **NVAL** The **NVAL** register is used to store the noise value. This is a **read-only** register.
- OSC1** The **OSC1** register is used to store the Channel 1 source amplitude value. The range of values which can be stored in this register depends on the amplitude level unit specified. For example, when the unit is dBm, the value range is -50 to +15 in steps of 0.1.
- OSC2** The **OSC2** register is used to store the Channel 2 source amplitude value. The range of values which can be stored in this register depends on the amplitude level unit specified. For example, when the unit is dBm, the value range is from -50 to +15 in steps of 0.1.
- PEP1** The **PEP1** register is used to store the Channel 1 port extension length value in cm. The range of values which can be stored in this register is from -999.99 to +999.99.

- PEP2** The **PEP2** register is used to store the Channel 2 port extension length value in cm. The range of values which can be stored in this register is from -999.99 to +999.99.
- PER1** The **PER1** register is used to store the Channel 1 reference input port extension length value in cm. The range of values which can be stored in this register is from -999.99 to +999.99.
- PER2** The **PER2** register is used to store the Channel 2 reference input port extension length value in cm. The range of values which can be stored in this register is from -999.99 to +999.99.
- PET1** The **PET1** register is used to store the Channel 1 test input port extension length value in cm. The range of values which can be stored in this register is from -999.99 to +999.99.
- PET2** The **PET2** register is used to store the Channel 2 test input port extension length value in cm. The range of values which can be stored in this register is from -999.99 to +999.99.
- ▶ **PI** The **PI** register is used to store the approximate value for π , 3.141 592 653 59. This is a **read-only** register.
- PTN** The **PTN** register is used to store the program point table number. The range of values which can be stored in this register is an integer from 1 to 4.
- ▶ **QV** The **QV** register is used to store the Q value. This is a **read-only** register.
- RBW** The **RBW** register is used to store the resolution bandwidth setting. The values which can be stored in this register is 3, 10, 30, 100, 300, 1000, 3000, 10000, 30000, 100000, and 300000.
- REF** The **REF** register is used to store the top of the display scale. The range of values which can be stored in this register is from -9.998E+37 to +9.999E+37.
- ▶ **RLOSS** The **RLOSS** register is used to store the Return Loss value displayed on the Polar format display. This is a **read-only** register.
- RQS** The **RQS** register is for storing the bit mask data of the HP-IB status byte. The value range is 0 to 255 integer number.
- Rn** The **Rn** registers are general purpose single registers. Where **n** is 0 to 99. The range of values which can be stored in these registers is 0 and values from $\pm 1E-37$ to $\pm 9.99999E+37$.
- SMKR** The **SMKR** register is used to store the value of the * marker position (in the X register domain). The range of values which can be stored in this register is from the START value to the STOP value.
- ▶ **SMKRA** The **SMKRA** register is used to store the data A value specified with the * marker. This is a **read-only** register.
- ▶ **SMKRB** The **SMKRB** register is used to store the data B value specified with the * marker. This is a **read-only** register.

- ▶ **SMTHC** The **SMTHC** register is used to store the C (capacitance) value displayed on the Smith Chart display. This is a **read-only** register.
- ▶ **SMTHL** The **SMTHL** register is used to store the L (inductance) value displayed on the Smith Chart display. This is a **read-only** register.
- ▶ **SMTHR** The **SMTHR** register is used to store the R (resistance) value displayed on the Smith Chart display. This is a **read-only** register.
- ▶ **SMTHX** The **SMTHX** register is used to store the X (reactance) value displayed on the Smith Chart display. This is a **read-only** register.

- SPAN** The **SPAN** register is used to store the sweep parameter SPAN value. The range of values which can be stored in this register depends on the type of sweep parameter selected. For example, when the frequency sweep parameter is selected, the range of values which can be stored in this register is from +0.002 to +499 999 999.999.

- ST** The **ST** register is used to store the sweep time value.

- START** The **START** register is used to store the sweep parameter's START value. The range of values which can be stored in this register depends on the sweep parameter selected. For example, when the frequency sweep parameter is selected, the range is from +0.001 to +500E+06.

- STEP** The **STEP** register is used to store the sweep parameter's STEP value. The range of values which can be stored in this register depends on the sweep parameter selected, and the values previously set for START, STOP, CENTER, SPAN, and NOP.

- STOP** The **STOP** register is used to store the sweep parameter's CENTER value. The range of values which can be stored in this register depends on the sweep parameter selected. For example, when the frequency sweep parameter is selected, the value range is from +0.001 to +500E+06.

- ▶ **VSWR** The **VSWR** register is used to store the VSWR value displayed on the Polar format display. This is a **read-only** register.

- ▶ **WID** The **WID** register is used to store the width value (LCURSR minus LCURSL). This is a **read-only** register.

- Z** The **Z** register is used to store the numeric data value for display on the system message line.

APPENDIX G

INDEX

This appendix lists the keywords described in this manual in alphabetical order, and provides the page **paragraph** numbers where the keyword is explained.

- A -

Accessory	7-22
Active probes	5-44
Addressable mode	6-35
AMPLITUDE key	2-6, 4-13, 4-29
Angle mode	4-3, 4-4, 5-13
APC-7 connector	3-8
Aperture	4-4
Arrey registers	4-56, 5-1
Arrow (Down/Up) key	2-4, 3-3, 3-5
Arrow (Left/Right) key	2-4
ASCII data format	6-41, 6-56
ASP (Auto Sequense Programming)	5-46, 6-1, 6-12, 6-24
AUTO indicator	2-5
AUTO key	2-5, 5-25
Auto scale	4-40
Average value	4-48

- B -

B (Susceptance)	4-14
BASIC statements	6-12
Battery back-up function	4-57
Binary operators	5-4, 5-10, 5-40
Blue shift key	2-3, 6-8, 6-20
BTM	4-38

- C -

Calibration	4-7, 4-16, 4-17, 4-18
Calibration/compensation data	4-17, 4-25, 5-2
Calibration data registers	5-2
Calibration standard value	4-9, 4-22, 4-57
CAL key	2-2, 4-18
CENTER key	2-5, 4-27
CHANNEL 1/2	2-6, 4-15
Characteristic impedance	4-9, 4-22
CLR LINE key	2-4, 6-25
C/N measurement	6-31
Complex matrix operation	5-13
Comment area	2-8
CONFIG key	2-2, 4-2

Control unit	1-2, 2-1
COPY key	2-3, 5-29
Copy mode	5-29
Cp (Parallel capacitance)	4-15
CRT	2-2, 2-8
Cs (Series capacitance)	4-15, 4-36
CURRENT LIMIT indicator	2-6

- D -

D (Dissipation factor)	4-15
DATA	5-45, 5-50, 6-24
Data output formats	6-26, 6-41
Data transfer	6-41
Data transfer rate	6-46
DC OUTPUT connector	2-6
dc source level	4-25, 4-27, 4-29
DC SOURCE area	2-6
DEFINE MATH key	2-2, 5-17
Delay aperture	4-4
DEL CHAR key	2-4, 6-25
Device dependant commands	6-12, 6-39
Disc drive	2-5, 5-45
DISPLAY key	2-2, 4-36
Display/measurement registers	4-35, 5-1
DIV	4-38
Dump mode	5-29, 6-63

- E -

Editor	6-6, 6-19, 6-20
EDIT area	2-4, 6-25
End of measurement (EOM) bit	5-39, 5-42, 6-47
End of sweep (EOS) bit	5-39, 5-42, 6-47
End status bit	6-47
ENTER/EXECUTE key	2-4, 5-14
ENTRY area	2-4
Environment	1-5, 7-5, 7-7
Equivalent circuit analysis mode	5-36
Equivalent circuit parameters	5-38
Error	6-25, 6-27, 6-39
Error status bit	6-47
EXT TRIGGER connector	2-7, 4-33, 4-34, 6-22, 6-28
EXT REFERENCE connector	2-7, 4-58
EXT REF indicator	2-5, 4-58

- F -

Flexible disc	5-46
FORMAT key	2-2, 4-3, 4-11
Frequency	4-24, 4-27, 4-29
Front handle kit	7-2
Function area	2-8, 4-2, 4-8, 4-25
Furnished accessories	1-1, 7-22

- G -

G (Conductance)	4-14
General purpose registers	5-1
Green shift key	2-3, 6-8, 6-20
Grid	4-36
Group delay	4-4

- H -

Hard copy	5-29, 6-29, 6-60
Header only type command	6-1
HP-IB	4-51, 5-18, 5-21, 5-22, 5-54, 6-1, 6-34
HP-IB bus commands	6-36
HP-IB connector	2-7, 6-50, 6-51
Hz/dB μ V key	2-4

- I -

IEEE 32bit binary data format	6-45, 6-58
IEEE 64bit binary data format	6-44, 6-57
IF range	4-30
Impedance measurement configuration	3-7, 4-2, 4-14, 5-36, 7-18
Initial settings	4-33, 4-51, 6-22
Input attenuator	4-30
Input damage level	4-30, 7-9, 7-14
Input port	4-3, 4-13, 4-15
INPUT R1/R2 connectors	2-6, 4-3, 4-13
Input range	4-30
INPUT T1/T2 connectors	2-6, 4-3, 4-13
INS CHAR key	2-4, 6-25
INTENSITY control	2-5
Isolation calibration	4-7, 4-18

- K -

Keyboard input line	2-8, 5-14
kHz/dBm key	2-4

- L -

LCL key	2-3, 6-36
LEVEL key	2-6, 4-29
Linear scale	4-37, 4-38
Linear sweep	4-28, 4-32
LINE FUSE holder	1-3, 2-7
LINE OFF/ON button	2-2
LINE VOLTAGE SELECTOR switches	1-4, 2-7
LOAD standard	3-9, 4-9, 4-22
Log scale	4-37, 4-38
Log sweep	4-28, 4-32
Lp (Parallel inductance)	4-15
Ls (Series inductance)	4-15, 4-36

LTN indicator 2-3

- M -

Marker area 4-43
MARKER/LINE CURSOR knob 2-3, 3-4, 3-6, 4-47
MARKER/LINE CURSOR area 2-3, 4-42
Masking the status byte 6-49
Math operation 5-4, 5-17, 6-12
MATH OPERATOR key 2-3, 5-4
Max hold 5-19, 6-33
MENU key 2-5, 4-33
Measurement configuration 4-2
Measurement data 4-35, 5-2
Measurement data area 2-9
Measurement parameter 4-3, 4-14, 4-17
MEASUREMENT UNIT 1-2, 2-1
MEASURE area 2-2
MHz/V key 2-4
MKR → key 2-3, 4-43
MODE key 2-3, 4-43
MORE key 2-3, 4-31, 5-21, 5-36, 6-35
Multiple numeric data type commands 6-2
Multiple registers 5-3
Multi-statement 6-24

- N -

Network measurement configuration 3-2, 4-3, 7-8
NEXT PAGE key 2-4, 6-25
Noise level 4-11, 4-44
Normalize (open) calibration 4-10, 4-18
Normalize (thru) calibration 4-7, 4-18
Number of measurement points (NOP) 4-28
Numeric data type commands 6-1

- O -

Offset compensation 4-18
OFF/ABORT key 2-6
One port full calibration 4-10, 4-16, 4-18
One port part calibration 4-10, 4-18
ON indicator 2-6
OPEN standard 3-8, 4-9, 4-22
Options 4-58, 7-2, 7-22
Oscillator level (OSC level) 4-1, 4-25, 4-27, 4-29
Output port 4-3, 4-13, 4-15
OUTPUT S1/S2 connectors 2-6, 4-3, 4-13

- P -

Partial analysis 5-21
Partial sweep 5-20
Phase expansion 4-41

Plot area	5-31
Plot mode	5-29, 5-31, 6-60
Plot pen selection	5-34
Plotter	5-30
Polar chart	4-36, 4-38
Port extension	4-16, 4-18, 4-23
Port selection	4-3, 4-13, 4-15
Power requirements	1-3, 7-7
PPT (Programmed Points Table)	6-24
PREV PAGE key	2-4, 6-25
PRESET key	2-5, 4-51, 6-22
Printer	5-30
Print mode	5-29, 6-29, 6-62
PROBE POWER jack	2-6, 5-44
Program control commands	6-18
Program editor mode	6-19, 6-20
PROGRAM key	2-3, 6-13
Programmed points measurement	5-23
Programmed points table	5-23, 6-32, 6-65
PROGRAM START connector	2-7, 6-28

- Q -

Q (Quality factor)	4-15, 4-46
Query commands	6-26, 6-38

- R -

R (resistance)	4-14, 4-36
Rack flange kit	7-2
Rack & handle kit	7-2
RBW	4-31
Rear panel lock foot kit	1-2, 7-22
RECALL key	2-4, 6-25
Rectangular A-B display	4-35, 4-38
Rectangular X-A&B display	4-35, 4-38
REF	4-38
REF ATTEN key	2-6, 4-31
Reflection calibration	4-8, 4-18, 5-2
Reflection coefficient (Γ)	4-4
Reference input	4-3
REFERENCE OVEN connector	2-7, 4-58
Reference signal output	4-58, 7-7
Remark sign (!)	6-17
RES BW key	2-5, 4-31
Resolution band width	4-11, 4-12, 4-31
Return loss	4-3, 4-36
Ripple measurement	6-30
RMT indicator	2-3
Rp (Parallel resistance)	4-15
RQS bit	6-37, 6-47
Rs (Series resistance)	4-15
R1/R2 indicator	2-6

- S -

SAVE/GET key	2-2, 5-49
Scale	4-37, 4-50
SCALE REF key	2-2, 4-36
Select type commands	6-2
Sending character to HP-IB	6-26, 6-50
Serial number	7-1
SHORT standard	3-8, 4-10, 4-22
Signal tracking	6-11, 6-33
Simulation	5-38
Single point trigger mode	4-33
Single registers	4-55, 5-3
Smith chart	4-36, 4-39
Softkey area	2-8
SPAN key	2-5, 4-27
S-parameter measurement configuration	3-12, 4-17
Special characters	5-15
SPECIAL FUNCTION area	2-2
Specifications	7-2, 7-7
Spectrum measurement configuration	3-5, 4-11, 7-15
SRQ indicator	2-3, 6-37
START key	2-5, 4-27
STATE	5-45, 5-50, 6-24
Status byte	6-37, 6-47
STOP key	2-5, 4-27
Storage function	4-41
String data type commands	6-2
Suffixes	5-14
Superimpose subtrace	4-40, 5-38
Sweep end function	6-1, 6-5, 6-23, 6-33
SWEEP indicator	2-5
Sweep range	4-24, 4-27, 4-50, 5-20, 5-23
SWEEP area	2-5
Sweep trigger mode	4-33, 6-22
Sweep time	4-29
Sweep type	4-28
Synchronizing with other instruments	4-58
System message line	2-8
S1/S2 indicators	2-6
S11 measurement configuration	3-12, 4-17, 5-36
S12 measurement configuration	3-13, 4-17
S21 measurement configuration	3-13, 4-17
S22 measurement configuration	3-13, 4-17, 5-36

- T -

Table display	4-35
Table number	5-23
Talk only mode	6-35
TEST ATTEN key	2-6, 4-31
Test input	4-3
Test signal level	4-15
TLK indicator	2-3
TRACE area	2-2
Tracking generator	4-13

Transmission calibration 4-7, 4-18, 5-2
 Trigger pulse 4-34, 6-28
 Trigger too Fast bit 6-47
TRIG/RESET key 2-5, 4-33
T1/T2 indicator 2-6

- U -

Unit 2-4, 4-3, 4-11, 4-27, 5-17, 5-25
UNLOCK indicator 2-5, 4-58
 User defined function 5-19, 5-21, 5-22, 6-1, 6-5, 6-33
 User math 4-15, 5-17, 6-33
 User program (ASP) 5-19, 5-21, 5-22, 5-45, 6-1, 6-12, 6-64

- V -

Version number 6-38
VIDEO FILTER indicator 2-5, 4-32
VIDEO FILTER key 2-5, 4-32
VIEW key 2-2, 4-40
VSWR 4-36

- W -

WAIT TRIG indicator 2-5
 Weight 7-4, 7-5, 7-7

- X -

X (Reactance) 4-14, 4-36

- Y -

Y (Admittance) 4-14

- Z -

Z (Impedance) 4-14

- Others -

0S/0Ω offset compensation 3-10, 4-16, 4-18, 4-23, 5-3
8 BIT INPUT/OUTPUT connector 2-7, 5-39, 7-7
10 MHz OUTPUT connector 2-7, 4-58, 7-7

NOTES

APPENDIX H

BLUE/GREEN SHIFT KEYS

BLUE SHIFT KEYS

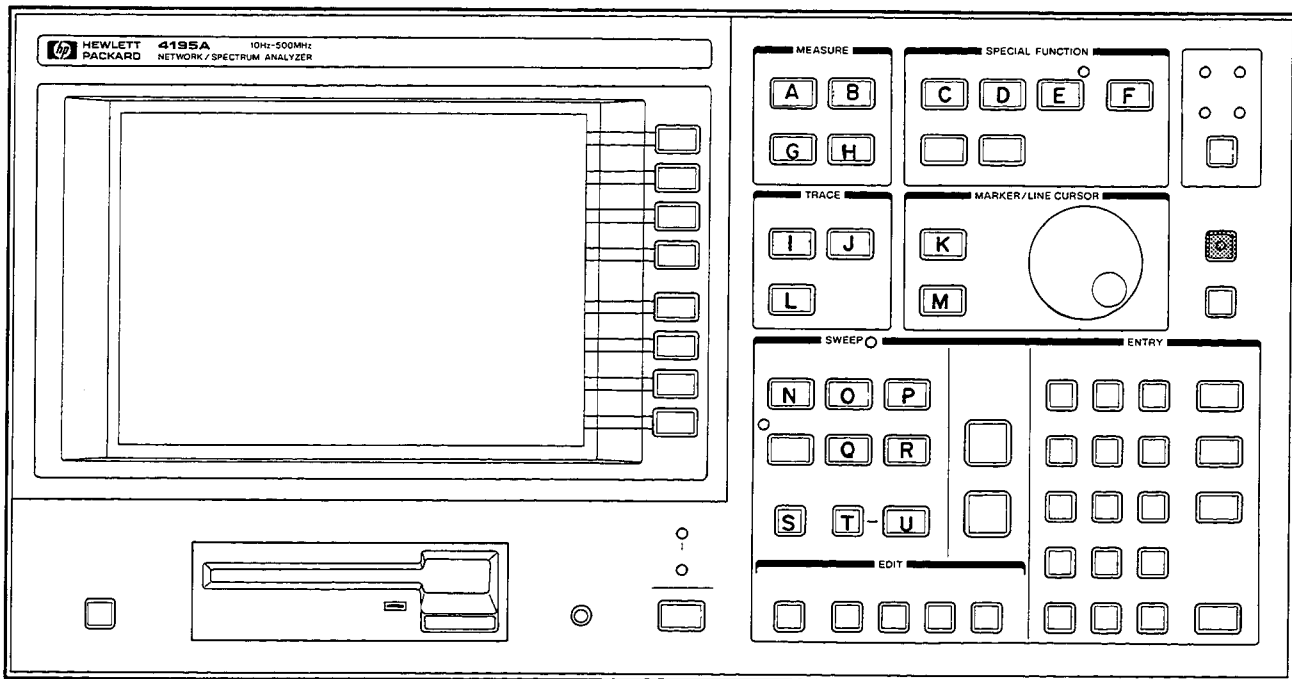

GREEN SHIFT KEYS

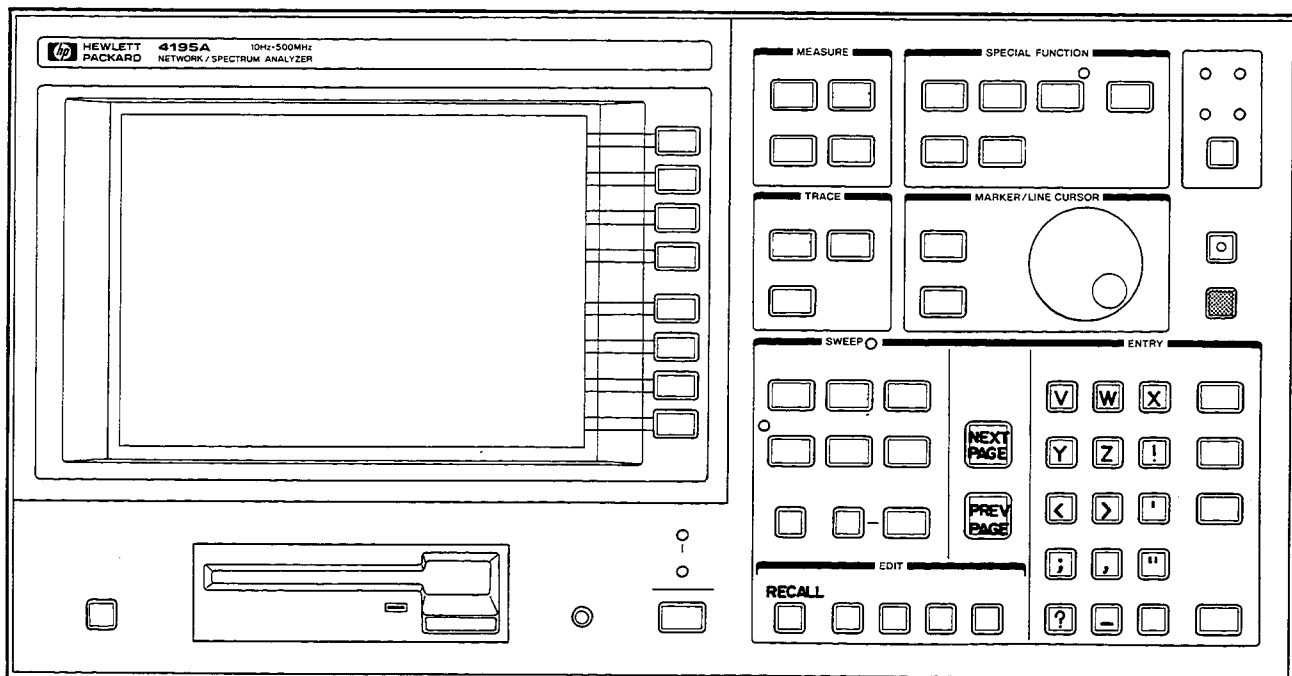

NOTES

FRONT/REAR PANELS

APPENDIX I

FRONT/REAR PANELS

This appendix illustrates the 4195A front and rear panels. The front panel illustration is printed on a fold out page, so you can see the front panel illustration while reading the other pages in this manual.

NOTE

Numbers enclosed in circles are numbers used for reference in Section 2.

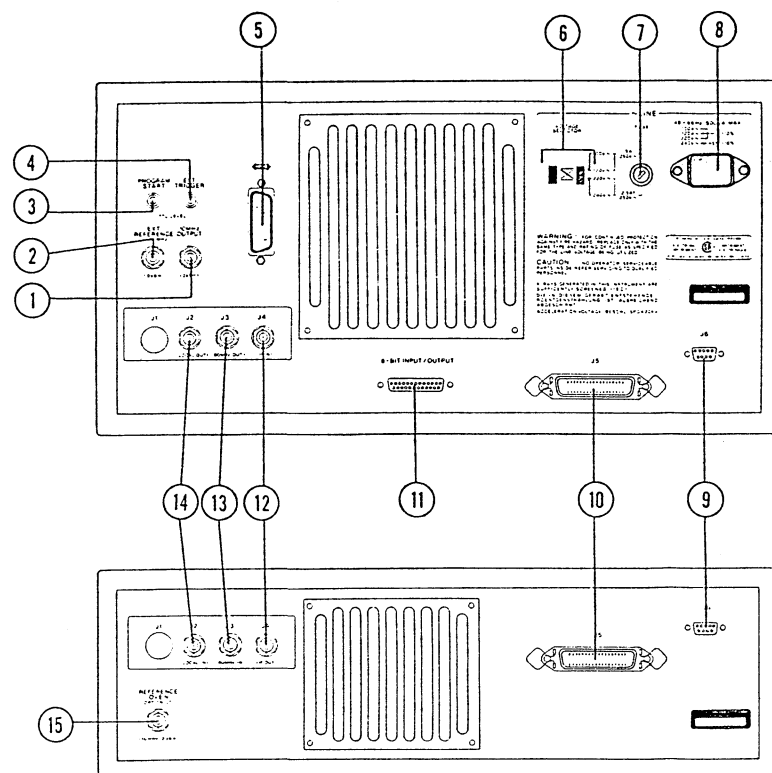

CONTROL UNIT

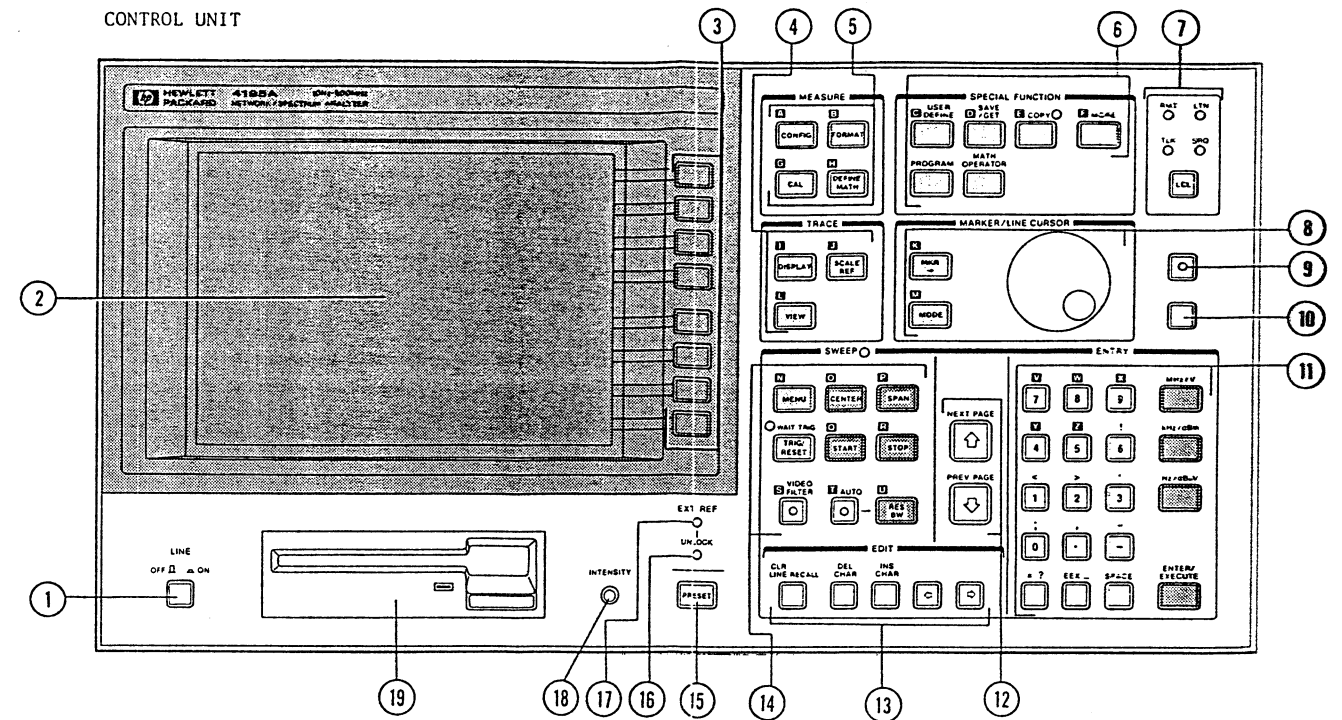

MEASUREMENT UNIT

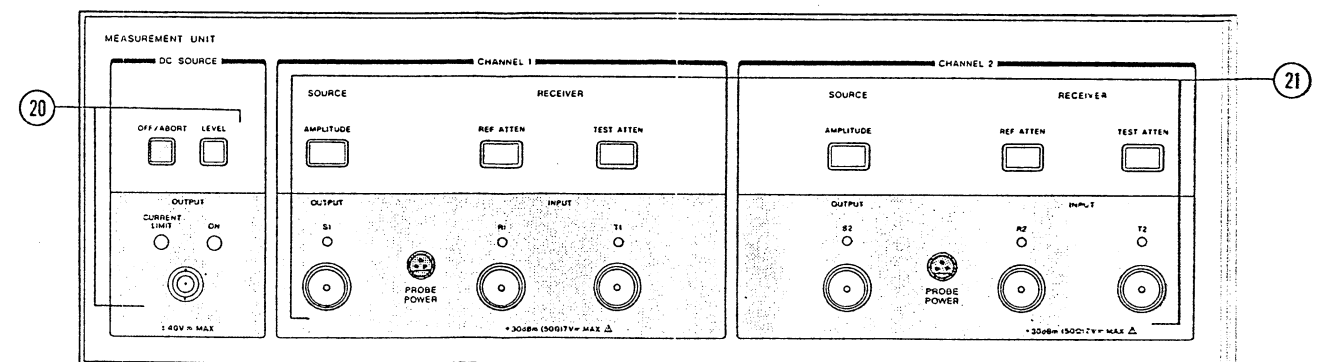

REGIONAL SALES AND SUPPORT OFFICES

For information relating to Sales or Support of Hewlett-Packard products first contact your local Hewlett-Packard office listed in the white pages of your telephone directory. If none is listed locally, contact one of the addresses listed below to obtain the address or phone number of the Hewlett-Packard Sales or Support office nearest you.

ASIA

Hewlett-Packard Asia Ltd.
47/F, 26 Harbour Road,
Wanchai, HONG KONG
G.P.O. Box 863, Hong Kong
Tel: (852)5-8330833
Telex: 76793 HPA HX
Cable HPASIAL TD

AUSTRALASIA

Hewlett-Packard Australia Ltd.
31-41 Joseph Street
BLACKBURN, Victoria 3130
Australia
Tel: (61)895-2895
Telex: 31-024
Cable: HEWPARD Melbourne

CANADA

Hewlett-Packard (Canada) Ltd.
6877 Goreway Drive
MISSISSAUGA, Ontario L4V 1M8
Tel: (416)678-9430
Telex: 069-8644

JAPAN

Yokogawa-Hewlett-Packard Ltd.
29-21 Takaido-Higashi, 3 Chome
Suginami-ku TOKYO 168
Tel: 03(331)6111
Telex: 232-2024 YHPTOK

MEDITERRANEAN AND MIDDLE EAST

Hewlett-Packard S.A.
Mediterranean and Middle East
Operations
Atrina Centre
32 Kifissias Avenue
Paradissos-Amarousion, ATHENS
Greece
Tel: (30)682 88 11
Telex: 21-6588 HPAT GR
Cable: HEWPACKSA Athens

May, 1990

BENELUX & SCANDINAVIA

Hewlett-Packard S.A.
Uilenstede 475
P.O. Box 999
NL-1183 AG AMSTELVEEN
The Netherlands
Tel: (31)20/43 77 71
Telex: 18 919 hpner nl

SOUTH & EAST EUROPE, AFRICA

Hewlett-Packard S.A.
7 rue du Bois-du-Lan
CH-1217 MEYRIN 2, Geneva
Switzerland
Tel: (41)22/83 12 12
Telex: 27835 hmea
Cable: HEWPACKSA Geneva

FRANCE

Hewlett-Packard France
Parc d'activites du Bois Briard
2, avenue du Lac
91040 EVRY Cedex
Tel: 1 6/077 83 83
Telex: 6923 15F

GERMAN FEDERAL REPUBLIC

Hewlett-Packard GmbH
Hewlett-Packard-Strasse
Postfach 1641
D-6380 BAD HOMBURG
West Germany
Tel: 06172/400-0
Telex: 410 844 hpbhg

ITALY

Hewlett-Packard Italiana S.p.A.
Via G. Di Vittorio 9
1-20063 CERNUSCO SUL
NAVIGLIO
(Milano)
Tel: 02/92 36-91
Telex: 334632

UNITED KINGDOM

Hewlett-Packard Ltd.
King Street Lane
Winnersh, WOKINGHAM
Berkshire RG11 5AR
Tel: 734/78/ 47 74
Telex: 847178

EASTERN USA

Hewlett-Packard Co.
4 Choke Cherry Road
ROCKVILLE, MD 20850
TEL: (301)670-4300

MIDWESTERN USA

Hewlett-Packard Co.
5201 Tollview Drive
ROLLING MEADOWS, IL 6008
Tel: (312)255-9800

SOUTHERN USA

Hewlett-Packard Co.
2000 South Park Place
P.O. Box 105005
ATLANTA, GA 30348
Tel: (404)955-1500

WESTERN USA

Hewlett-Packard Co.
5161 Lankershim Blvd.
P.O. Box 3919
NO. HOLLYWOOD, CA 91609
Tel: (818)506-3700

OTHER INTERNATIONAL AREAS

Hewlett-Packard Co.
Intercontinental Headquarters
3495 Deer Creek Road
PALO ALTO, CA 94304
Tel: (415)857-1501
Telex: 034-8300
Cable: HEWPACK

